

Entry System Connection Options and Cloud Programming– Your Choice

DoorKing entry system connection options now include the DoorKing Cloud as an added benefit at no additional cost. Using the DoorKing Cloud, you can program and manage your access system from any device (laptop, tablet, smartphone) with an internet connection – a dedicated PC is no longer needed. The DoorKing Cloud is included with Cellular, VoIP, DoIP, IM Server and 2112 system subscriptions. Customer software programming support (phone, chat, email) is included with any DoorKing subscription account.

For more information, please visit:

1830 Series Systems: <https://www.doorking.com/cloud>

2112 Series Systems: <https://www.doorking.com/2112>

A word about Plain Old Telephone Service (POTS)

The telecommunication infrastructure is changing to digital and fiber networks, some of which do not support modem communications. For these reasons, DoorKing does not recommend using POTS lines for your entry system programming or voice communication requirements.

Programming your DKS telephone entry / access control system using legacy modem-to-modem connections (a modem and phone line at your PC) is becoming difficult to maintain. Modems are essentially obsolete and their performance is affected by the type of telephone service at your PC. There are also many variable factors that can affect the modem, including the brand and model of the programming PC, which OS version is in use, is the modem connected directly to the PC or through a USB Hub, brand and chipset versions of the modem and modem driver updates. Existing modem-to-modem connections may become unreliable as telephone providers update their systems and infrastructure and as your PC performs updates. These factors are beyond the control of DoorKing.

As of January 1, 2017 DoorKing will no longer offer technical support for communication failures between a PC modem and the DKS entry system modem. If the modem connection is found to be functional at the DKS entry system and DoorKing tech support personnel can connect to it via the DKS IM Server connection service, then this will be the recommended corrective action. Alternately, troubleshooting the PC modem will be the responsibility of the owner and their IT (Information Technology) personnel.

Because of these reasons, DoorKing offers a variety of connection options for our telephone entry and access control systems. **You DO NOT have to subscribe to any DoorKing connection services for your entry system to be serviceable¹.** The connection options in this price schedule offer easy plug & play connection methods. Other (non-subscription) methods of connection are available but these may require additional hardware, subscriptions to other service providers or internet services and IT personnel for setup requirements (setting up routers, firewalls, port forwarding, DDNS (Dynamic Domain Name System) charges or static IP addresses). In many cases, you will find that the DoorKing options are less costly than legacy options such as a POTS (Plain Old Telephone Service) business line or VoIP (Voice over Internet Protocol) service providers and any DoorKing subscription includes customer software programming support (phone, chat, email)².

Be sure to visit the DoorKing web site for complete terms and conditions of using DoorKing connection service products.

1. Does not apply to DoorKing model 2112 Video Entry System. The 2112 requires the Standard Residential Package at \$19.95 per month to operate.
2. Customer software programming support for non-subscription connection services is available for a yearly fee.

Table of Contents

Connection Options

DKS Cellular	4
DKS Internet	6
DKS IM Server	8
DKS 2112 Video Entry System	10
Software Programming Support.....	12

Cellular Connection

Wireless

DKS Cellular

- Plug & Play
- No phone lines or internet cables to run
- No obsolete slow modems
- Crystal clear sound – no hums or buzzes
- Practically immune to power surges / lightning
- Connect up to two (2) systems
- Includes software programming support
- Competitive monthly rates

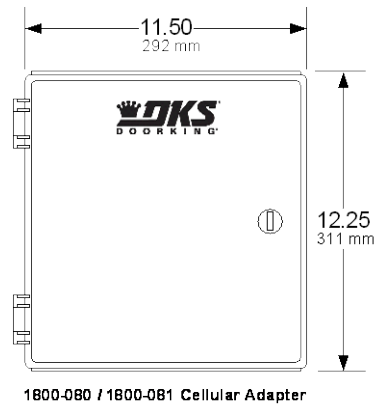

Model	Service ¹	Voice ²	Data ³	Use With
1800-080	DKS Cellular	Yes	Yes	1802, 1803, 1808, 1810, 1833, 1834, 1835, 1837, 1838
1800-081	DKS Cellular	Yes	Yes	1802 AP, 1808 AP, 1810 AP, 1812 AP, 1838 AP

1. DKS Cellular is provided by AT&T 4G-LTE where available.
2. Voice only cellular service will not support modem communications.
3. Data means the ability to program the entry system from your PC with the DoorKing software application.

Cellular Connection

Wireless

DKS Cellular

DKS Cellular is a wireless option that replaces standard telephone lines and internet connections and offers voice communication and/or data (programming) to the DKS telephone entry / access control system via the AT&T 4G LTE cellular network (where available). DKS Cellular is available in all states including Alaska and Hawaii and is also available in Puerto Rico, all U.S. territories, Canada and Mexico. This is a monthly cellular subscription service without any long term contracts. DKS Cellular plans include all taxes, fees and charges for voice and data communication, including long distance charges.

Billing is based on a combination of voice minutes and/or number of data transfers during the monthly billing period. A data transfer is defined as: receiving data; sending data; receiving transactions. Exceeding either voice minutes or data transfers at one billing level will move you into the next billing level for that billing period. As such, you may see different billing amounts on a month to month basis. Please note that if you terminate the service, you will receive a final billing on your normal billing date for services used prior to the termination.

There is a one-time activation fee of \$45.00 for each cellular control box registered. There is a \$2.00 / month discount offered on all cellular plans if auto-pay (via credit card or e-check) is selected.

See Section A 2.0, page 32 for cellular control box prices.

Voice + Data Plans			
Voice Minutes / Month	Data Transfers / Month	Monthly Fee	Applies to:
Up to 100	Up to 6	43.95	1800-080, 1800-081
101 – 450	7 – 60	53.95	
451 – 1200	61 – 90	63.95	
1201 – 2500	91 – 120	73.95	
2501 +	121 +	79.95	
Voice Only Plans			
Voice Minutes / Month	Data Transfers / Month	Monthly Fee	Applies to:
Up to 100		38.95	1800-080
101 – 450		45.95	
451 – 1200		53.95	
1201 – 2500		61.95	
2500 +		68.95	
Data Only Plans			
Voice Minutes / Month	Data Transfers / Month	Monthly Fee	Applies to:
	Up to 60	32.95	1800-080, 1800-081 (Use data only plans with 1838-081 and 1838-095 products)
	61 - 120	42.95	
	121 +	52.95	

Internet Connection

Wired (Ethernet)

DKS Internet

- VoIP connection
- Data connection
- Plug & Play
- Includes software programming support

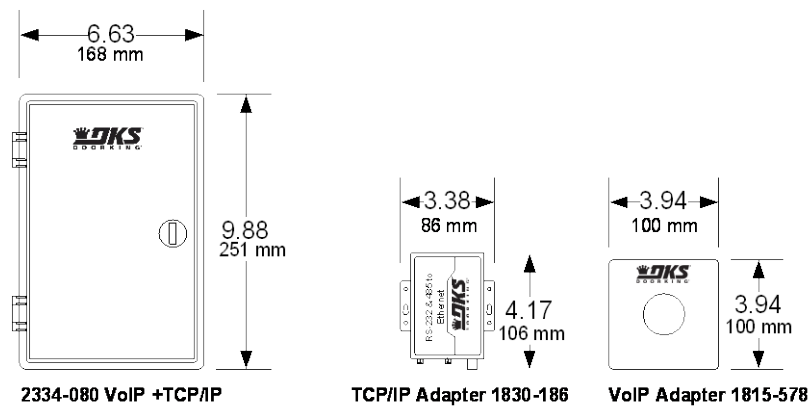

Model	Service ¹	Voice	Data ²	Note ³
2334-080	DKS Internet	Yes	Yes	Provides voice + data connection for 1833, 1834, 1835, 1837, 1838
1830-186	DKS Internet	No	Yes	Provides data connection only for 1833, 1834, 1835, 1837, 1838
1815-578	DKS Internet	Yes	No	Provides VoIP. No data (programming) with this. Can be used to replace POTS lines on most telephone entry systems that do not require remote programming.

1. DKS Internet will not support modem communications.
2. Data means the ability to program the entry system from your PC with the DoorKing software application.
3. The 1830-186 and 1815-578 can be used separately to provide both voice (VoIP) and data (programming) features. However, this would require two (2) separate Ethernet wire runs from your router (one to each device) or the installation of an Ethernet switch.

Internet Connection

Wired (Ethernet)

DKS Internet

DKS Internet allows you to replace POTS (Plain Old Telephone Service) lines with your internet connection and offers voice (VoIP) communication or data (programming) to the DKS telephone entry / access control system.

DKS Internet requires a network (Ethernet) connection from your router to each of the DoorKing connection devices (2334-080, 1830-186, 1815-578). A single connection can be used with the 2334-080. You should note that distance limitations on network wiring do apply. Ethernet wire runs are limited to 330 feet (100 m) maximum.

This is a flat rate monthly or yearly subscription service without any long term contracts and includes all taxes, fees and charges for voice and/or data communication. There is a 5% per month discount offered if auto-pay (via credit card or e-check) is selected.

See Section A 2.0, page 32 for connection device prices.

DKS Internet			
Plan	Pay per Month	Pay per Year	Notes
VoIP + Data	27.95	307.45	Use this plan with the 2334-080 for voice and data connections.
VoIP Only	23.95	263.45	Use this plan with the 1815-578 for voice communication only.
Data Only	8.95	98.45	Use this plan with the 1830-186 for programming only.

Telephone Line Connection

Wired (POTS)

DKS IM Server Modem^{Pat: 9,049,306}

- Plug & Play data transfer (programming)
- Uses your computers internet connection
- Uses the POTS (Plain Old Telephone Service) line at the entry system
- Includes software programming support

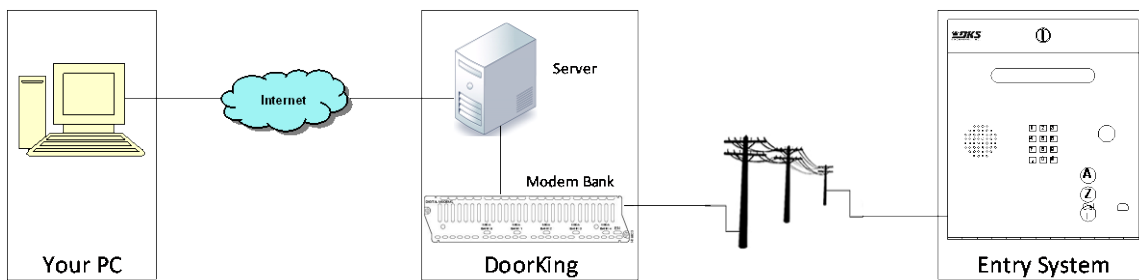

1. No connection hardware to purchase or install.
2. Uses the internet connection at your PC to send programming data to the DoorKing server.
3. The DoorKing server transfers the data to an open modem in our modem banks.
4. The modem uses plain old telephone service (POTS) to place a call to the entry system.
5. When the handshake between the modem and the entry system is verified, data is transferred via modem communication.
6. Acknowledgement upon programming completion is sent back to your PC.

Telephone Line Connection

Wired (POTS)

DKS IM Server Modem¹

DKS IM Server utilizes the POTS (Plain Old Telephone Service) line connected to the entry system to transfer (send) programming data to the DKS telephone entry / access control system via the internet connection at your programming computer. Voice communication is provided over the POTS line². This service is useful if your programming PC does not have a modem, or if your modem cannot communicate with the entry system modem. This is a monthly subscription service without any long term contracts and includes taxes and charges for the data communication only³. DKS IM Server Modem is only available for use with 1830 series and Access Plus series systems.

You should also be aware that many telecommunication companies no longer support or install POTS lines. Additionally, the telecommunication infrastructure is changing to digital and fiber networks, some of which do not support modem communications. For these reasons, DoorKing does not recommend using POTS lines for your entry system programming or voice communication requirements. The preferred connection method for your entry system should be via a cellular or internet connection.

Billing is based on the number of tenants/residents in the entry system database. You should also be aware that DoorKing maintains the right to determine excessive usage (data transfers) at any time and may require you to reduce your usage (data transfers). Failure to comply may result in service termination.

1. The IM Server Modem (Pat: 9,049,306) is maintained only as a convenience for legacy customers still using a POTS line as their voice/data connection method. DoorKing does not recommend using a POTS line for your voice/data connection. We can no longer guarantee modem connections as some phone company services and switches no longer support modem communications since these devices are considered to be obsolete technology.
2. The telephone line at the entry system must support G.711 level service for the IM Server Modem to work. You should also be aware that modem communications will not work over cellular or VoIP connections.
3. The user is responsible for all phone company charges including local and long distance charges, taxes and other fees associated with the POTS line connected to the entry system.

DKS IM Server		
Residents/Tenants	Pay per Month	Pay per Year
0 - 100	13.95	153.45
101 - 250	16.45	180.95
251 - 500	18.95	208.45
501 +	22.45	246.95

A Word about POTS

Programming your DKS telephone entry / access control system using legacy modem-to-modem connections (a modem and phone line at your PC or DoorKing modem banks) is becoming difficult to maintain. Modems are essentially obsolete and their performance is affected by the type of telephone service at your PC. There are also many variable factors that can affect the modem, including the brand and model of the programming PC, which OS version is in use, is the modem connected directly to the PC or through a USB Hub, brand and chipset versions of the modem and modem driver updates. Existing modem-to-modem connections may become unreliable as telephone providers update their systems and infrastructure and as your PC performs updates. These factors are beyond the control of DoorKing and for these reasons, we do not recommend using a POTS line for your entry system voice/data connection.

As of January 1, 2017 DoorKing no longer offers technical support for communication failures between a PC modem and the DKS entry system modem. If the modem connection is found to be functional at the DKS entry system and DoorKing tech support personnel can connect to it via the DKS IM Server connection service, then this will be the recommended corrective action. Alternately, troubleshooting the PC modem will be the responsibility of the owner and their IT (Information Technology) personnel.

2100 Series Video Entry System

Residential

2108 / 2112

- Control up to three entry points
- Broadcast calling up to four phone numbers
- Internet or cellular connection
- Program from a laptop, tablet or smartphone
- All programming saved in the DKS Cloud

App

- DKS 2112 Resident app
- Initiate video stream at any time from the app
- Activate door or gate from the app
- Check door/ gate status
- Includes software programming support

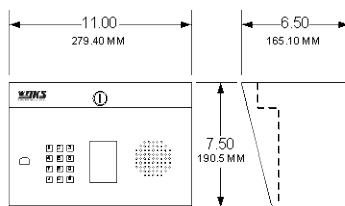

2108 Surface Mount

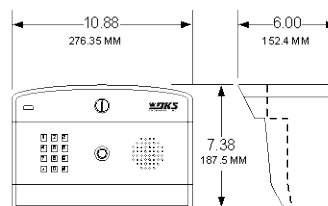

2112 Surface Mount

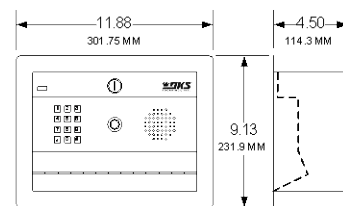

2112 Flush Mount

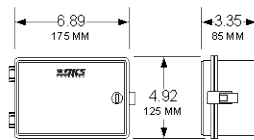

Cellular Kit External use with
 2108 / 2112

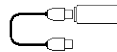

Cellular Kit Internal use with
 2112 Surface Mount Only

Model ¹	Phone Numbers ²	Directory Codes ³	Entry Codes ⁴	Relays	Auxiliary Inputs	IP Camera	Cloud Programming ⁵	Do Not Call Schedule	Hold Open Schedules	Mount
2108 ⁶	40	10	25	3	0	Yes	Yes	Yes	Yes	Surface
2112	40	10	25	3	0	Yes	Yes	Yes	Yes	Surface Flush

1. The 2108 / 2112 must have an internet connection (wired or cellular) to operate. Standard residential package subscription fee (\$19.95 / month) is required.
2. Up to four (4) phone numbers per directory code.
3. Directory codes can be set for one (1) to five (5) digits in length.
4. Entry codes can be set to four (4) or five (5) digits in length.
5. Program from a laptop, tablet or smartphone.
6. 2108 has a small built-in paper directory that can hold up to 10 names.

2100 Series Video Entry System

Residential

2108 / 2112

The models 2108 and 2112 Video Entry Systems require the Standard Residential subscription package to operate. Without this monthly subscription, the entry system will not function. This monthly subscription includes:

- VoIP for Voice Calling
- Video Calling (requires the DKS 2112 app on your smartphone)
- DKS Cloud database for programming and system management
- On command video monitoring (from your smartphone)
- Relay (door/gate) status (open – closed – held open)
- On command relay control (open – close – hold open)
- Scheduled relay control
- Entry code functions

To setup your account, register and activate the 2108 / 2112, go to: <https://dks2112.com/index/login>

The DKS Residential app is required for video viewing and is a free download at the App Store or Goggle Play.

An internet connection is required. This can be by a direct hard wired connection (Ethernet cable) or a wireless connection (wireless access point) from the homeowner’s router to the 2108 / 2112 (homeowner supplies required hardware). If it is not possible to make an Ethernet connection from the homeowner’s router to the 2112, a cellular option is available at an additional monthly fee to provide internet access to the 2108 / 2112. See the fee chart below.

Subscription Plan	Pay per Month	Notes
Standard Residential Package	19.95	This fee is required, otherwise the 2108 / 2112 will not operate.
Cellular Connection Options		
T-Mobile Cellular Add-on	15.95	This is in addition to the standard residential package fee.
AT&T ¹ Cellular Add-on	19.95	This is in addition to the standard residential package fee.

1. AT&T cellular service requires Minimum Build 32 (check your 2108 / 2112 online account event log – type “build” in the search bar).

Software Programming Support

Direct (non-subscription) Connections Only

This optional software programming support subscription plan is only needed if the entry system is connected directly to the programming PC by one of the methods shown below. Software programming support IS included with all DoorKing connection services (Cellular, VoIP, DoIP, IM Server).

- Using a modem and a POTS (Plain Old Telephone Service) line for data transfers
- Using an RS-232 connection from the computer directly to the DoorKing entry system
- Using an RS-232 to RS-485 connection directly from the DoorKing entry system to the computer
- Any other type of direct connection from the computer to the DoorKing entry system that does not use a DoorKing subscription connection service

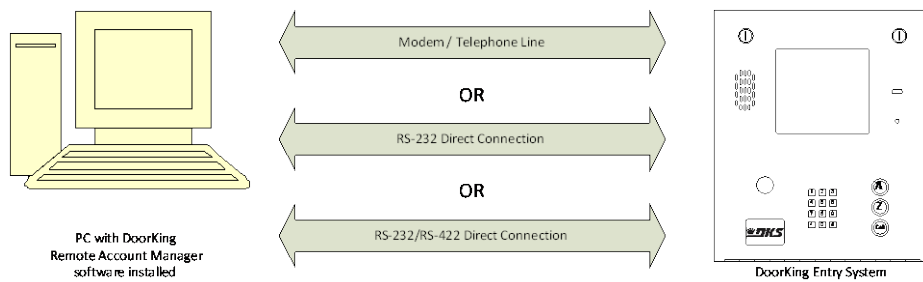

Software Programming Support

Direct (non-subscription) Connections Only

- Software Programming Support means that DoorKing will provide the Customer with telephone, chat and email software programming assistance.
- Phone, chat and email support is available Monday through Friday, 5:00 AM to 5:00 PM Pacific Time - excluding weekends and observed U.S. Holidays. Support availability may occasionally vary from stated hours due to downtime for systems and server maintenance, company events, and circumstances beyond the control of DoorKing. Phone and chat support requests will be handled in the order in which they are received. Email support requests will be processed within one (1) business day.
- Software Support Agreements will be directly associated with a telephone number connected to the DoorKing telephone entry / access control system. Customer will be required to provide the telephone number prior to receiving support.
- Customer will be provided with software support services only for DoorKing software.
- Software Programming Support does not include troubleshooting any problem caused by a failure of the software to transfer programming data to the companion DoorKing access control entry system caused by failure of modem to modem communication, failure of a network (internet) connection, failure of an RS-232 connection, failure of any hardware device required to establish data communication.
- See the Software Support Agreement for complete terms and conditions of the Software Support Program.

To setup your account, go to: <http://dksdb.dksoftware.com/NewUserRegChoice.aspx>

Subscription Plan	Pay per Year	Notes
Software Programming Support	49.95	Support commences when the yearly fee is paid.

