

# DOORKING SYSTEMS

access control solutions<sup>TM</sup>

---

## GROUNDING AND SURGE SUPPRESSION

---

THE KEYS TO GOOD GROUND

LIGHTNING MYTHS AND REALITIES

KEYS TO EFFECTIVE SURGE SUPPRESSION

- Placement and Location of Surge Suppression as related to Equipment and Ground.

LEVELS OF SURGE SUPPRESSION

- **Grounding and Surge Cluster**
  - **Operator and Phone Entry**
  - **Operator, Entry and Readers**
-

---

## THE PURPOSE OF GROUNDING

---

All DoorKing products, and many other electronic systems, are designed with a significant amount of **Inherent Surge Suppression**. A key factor in the performance of this surge suppression is to provide the system with a good Ground point. There are many benefits that a good ground can provide, including:

- To Limit and Stabilize voltage to ground during normal electrical system operation.
- Help to prevent damages due to excessive voltages.
- Helps prevent damage from Inductive Loads.
- Provide protection against contact with higher voltage lines.
- Enhances surge suppression for against **Transient Voltage** (Lightning)
- Provides protection against damage from static discharges.

Good grounding practices will help to prevent injury to persons and damage to equipment.

---

## KEYS TO PROVIDING A GOOD GROUND.

---

- ❑ Consider this: Many electrical codes are based upon a **Ground System that will provide a good ground connection for 40 years!** Utilize quality materials and proper ground connectors for your grounding system.
- ❑ **A ground rod should be provided for the access system.** The NEC recommends that the ground rod be a copper clad rod, no smaller than 5/8" in diameter and no less than 8' in length, with a minimum of 8' buried in the ground. Check with local regulations for specifics on the grounding rod.
- ❑ **Please note: a metal fence post, goose neck mounting post or metal frame of an operator is not considered an earth ground!** These items are generally not deep enough into the ground and are insulated by concrete.
- ❑ **Utilize a Single Point Ground.** Provide a **Ground Buss** to connect all Grounds to local ground rod. This includes Case Ground, Electrical Ground, Surge Suppression Grounds, etc.
- ❑ **Electrical Supply Ground** - Utilizing the "Green Wire" ground from an electrical panel may result in performance related problems for various devices:
  - ✓ Telephone Entry Systems - The "Green Wire" Electrical ground may carry a 60hz "Hum", inducing noise into the phone entry system.
  - ✓ Lightning Surge Protection - The "Green Wire" Electrical Ground is typically not close enough to provide the level of drainage to ground required for proper Transient Surge Suppression.

It is recommended to provide a Ground Rod for the Entry System and for Surge Suppression

Some information within this document section provided by: Fred Williams, FCI Burndy Electrical and from DITEK technical support.

---

## LIGHTNING MYTHS AND REALITIES

---

### LIGHTNING MYTH'S - A Bolt of Lightning just "Blew Up" my system

**LIGHTNING REALITIES** – Many people assume that "Lightning Damage" must come from a direct Lightning Strike. The truth is that a direct Lightning Strike is extremely rare. Studies have shown that the following comparison of Surge Related Damage to equipment:

- 2% of all Surge related equipment failures are due to Direct Lightning Strikes. There is no effective protection against a direct lightning strike
- 98% of all Surge related equipment failures are the result of:
  - ✓ Proximity Lightning Strikes - Lightning can strike a Power or Phone line and be carried transmitted down these wires, **damaging equipment many miles away!**
  - ✓ Utility Grid Overload
  - ✓ Atmospheric Discharge (Static discharge induced onto aerial lines)
  - ✓ Induction Loads (the cycling of power ON / OFF)

It is this 98% that you can help address by providing additional transient voltage surge protection. DoorKing equipment has a significant amount of surge protection built in to our control boards. When the system is properly grounded this will help protect against static, induction loads and some utility grid overloads. However, this does not provide sufficient protection against damage during periods of Lightning activity. We strongly recommend the addition of Transient Voltage Surge Suppression.

---

## LIGHTNING SURGE SUPPRESSION

---

### *"So why did my equipment get damaged, when I had Surge Suppression Devices installed?"*

The effectiveness of Surge Suppression is directly related to the proper placement and installation of the Suppressor, and the quality of the Ground connection. The most common mistake is in the distance between the Surge device and the Ground.

Take care when selecting a Surge Protection device. Some inexpensive brands can induce noise into the telephone lines, and some brands only provide a **One-Shot Suppression cycle**. After they absorb a surge they may short out and no longer provide protection.

Another question that often arises is, "Where do I locate Surge Suppression"? To answer this you need to consider the parameters of your project site:

- What equipment is included in your system?
- Where do the incoming Power and Phone Lines terminate near the equipment?
- Where the location of Ground is (ground rod for entry system)?
- Is there additional equipment that is remotely located (Reader devices? Tracker Boards?) Is this equipment powered from a different source than the controller?

## GENERAL SURGE SUPPRESSION GUIDELINES

- ☑ **Keep Drain Wire from Surge Suppressor to Ground AS SHORT AS POSSIBLE -**  
This is probably one of the most important and most overlooked factors in surge protection. The Surge Suppressor must have a **short path to ground** for dissipation of the Power Surge.

When dealing with the massive levels of voltage found in a Lightning Surge, **the ground wire can gain a resistance of up to 100 Volts per foot!**

For example, if the surge grounding rod is located 30' away from the Surge Protector, you may have up to **3000 Volts** of charge in the line before the Surge is dissipated!

**Common Oversight: Placing Ground too far away from Surge Device.**

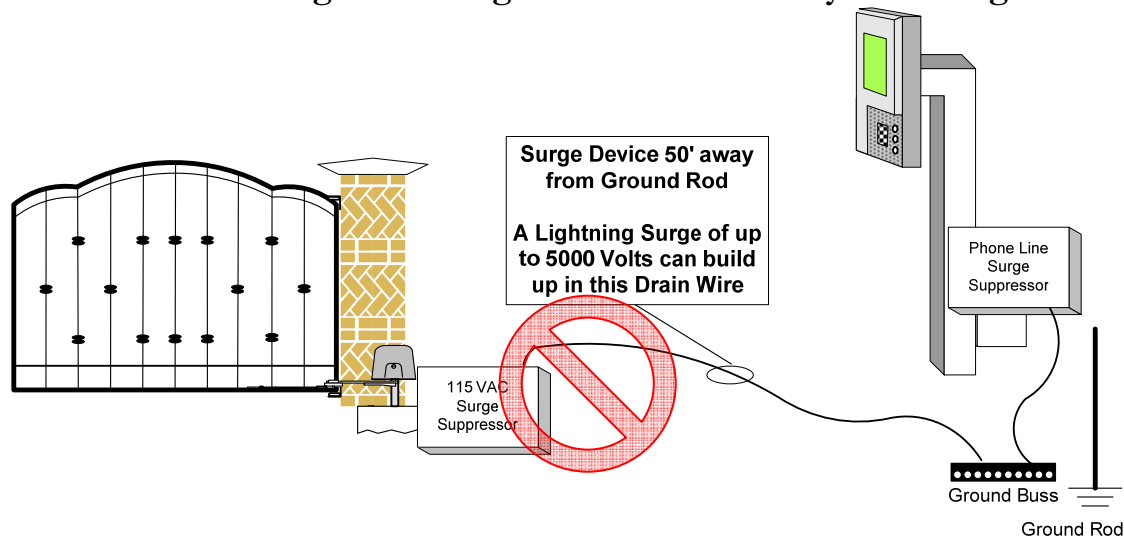

**For Best Results, locate the Surge Suppression Devices at the Ground Rod, then run to the equipment you are protecting!**

**All Surge Devices located at the Ground Rod**

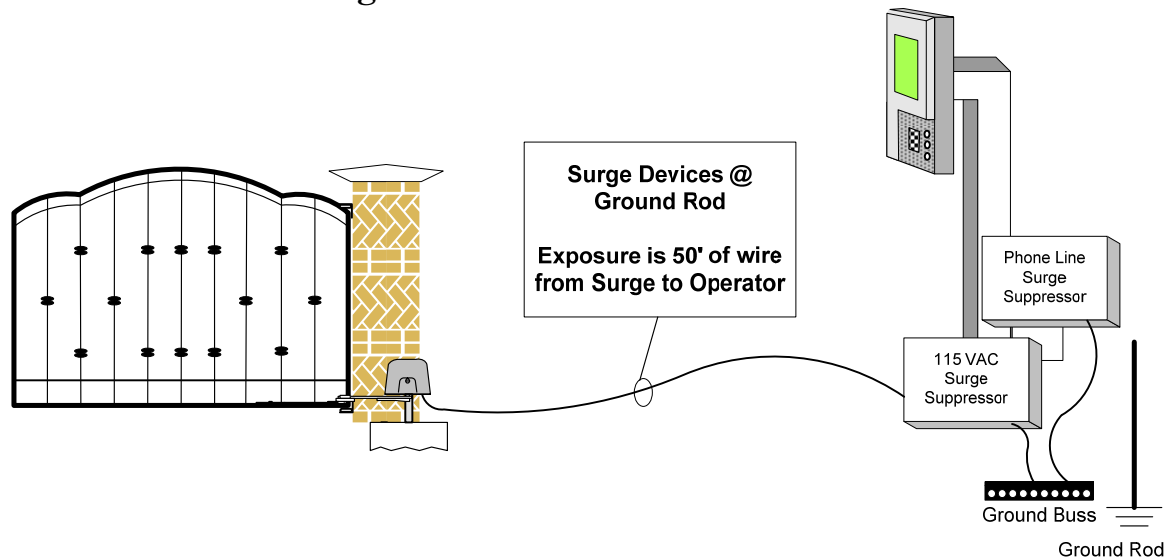

## PHONE SYSTEMS: LOCATION OF SURGE PROTECTION DEVICE

Where do you place the Surge Suppressor for a Telephone Entry System?

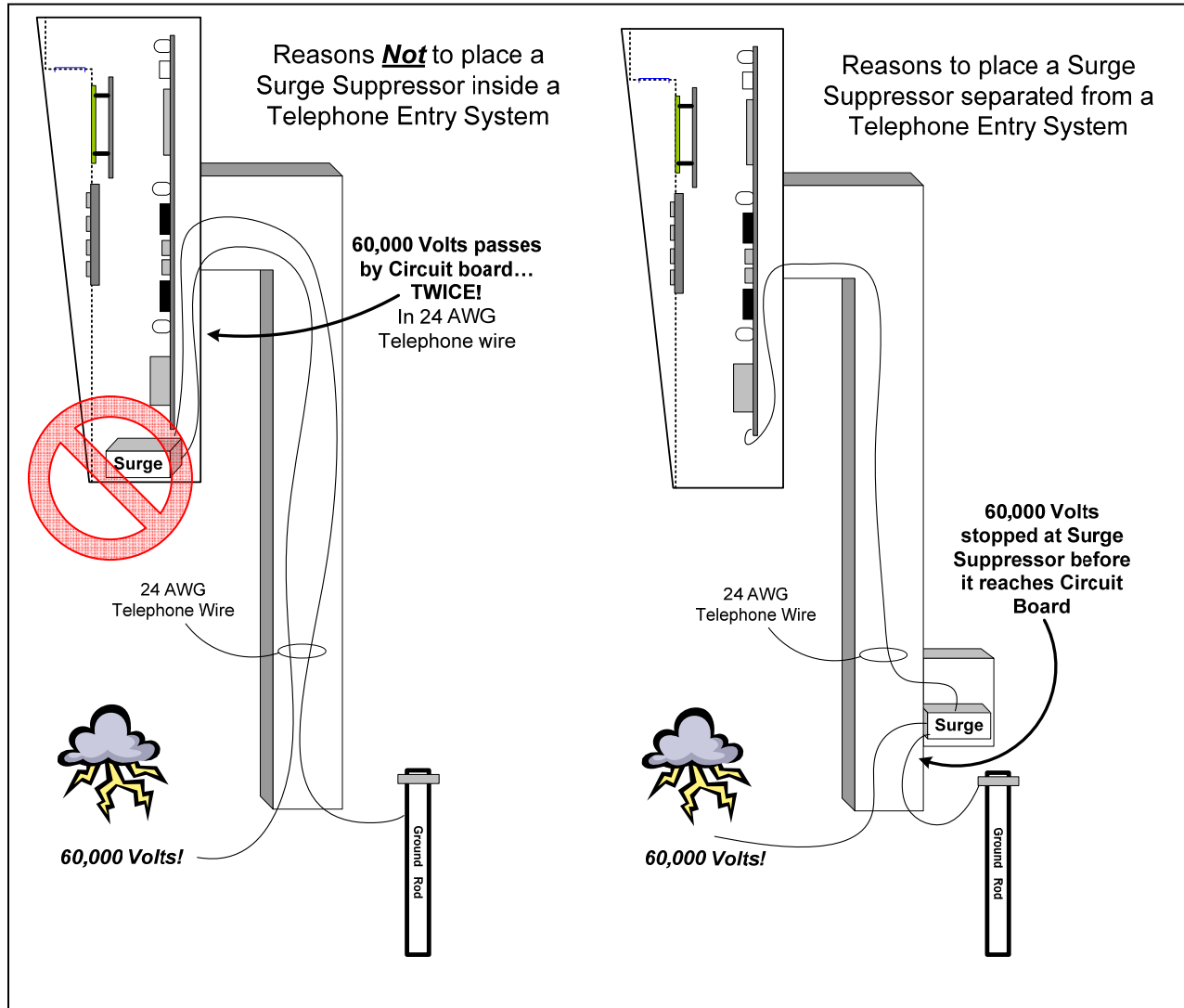

- ☑ Remember, Lightning voltage is traveling through your wiring! That's 60,000 volts in the telephone wire going into the Entry System housing, then 60,000 volts in the ground wire exiting the Surge Suppressor.
- ☑ If you place the Surge Suppressor inside your Entry System you are making sure that the lightning voltage will reach the Phone Entry System before it can get to the Ground Rod. This is also true for Gate Operators
- ☑ **GOOD RULE: DO NOT PLACE THE SURGE SUPPRESSION DEVICE INSIDE THE EQUIPMENT YOU ARE TRYING TO PROTECT!**

---

## GENERAL SURGE SUPPRESSION GUIDELINES

---

Follow grounding requirements and practices for your region of the country. If there is difficulty in setting a Ground Rod, contact a local electrician.

- ❑ **Build a Firewall: Isolation and suppression against surges on all Incoming Lines -**  
This creates a “Fire Wall” against surges that may enter the property from outside sources. These may include:
  - ✓ Incoming Electrical Power Lines
  - ✓ Incoming Communication Lines (Phone Lines)
  
- ❑ **“Ground Rod Rule” Provide a GOOD GROUND -** The importance of providing a good ground cannot be over emphasized. The Ground Point should be close to the equipment being protected. This will provide a quick path to ground for any power surge or spike. Ideally, provide a good Ground Rod for the entry system and all related components. **Locate surge protection devices at the Grounding Point!**
  
- ❑ **Create a Grounding/Surge Equipment Cluster -** All surge protection devices for equipment within the “Cluster” should connect to a single grounding point. This should provide the all ground connections for equipment within this “Cluster”, including:
  - ✓ High Voltage Surge Suppressors
  - ✓ Low Voltage Power Surge Suppressors
  - ✓ Low Voltage “Wiegand” suppressors
  - ✓ Phone Line Suppressors
  - ✓ All Equipment Grounds.
  
- ❑ **Consider Equipment outside of “Cluster” -** Equipment outside of the Ground Cluster typically may have separate Power, Communication and Ground sources. When a Surge affects the “Cluster” it is dissipated to Ground, resulting in a rise in the value of ground at the Cluster. The value of ground at the Remote Equipment may not rise at the same level. When this occurs, the Surge may flow or drain towards the lower value of ground, resulting in potential for damage to the remote equipment.  
**Create Grounding / Surge clusters for remote access devices within a single area.**

## GROUND / SURGE EQUIPMENT CLUSTER

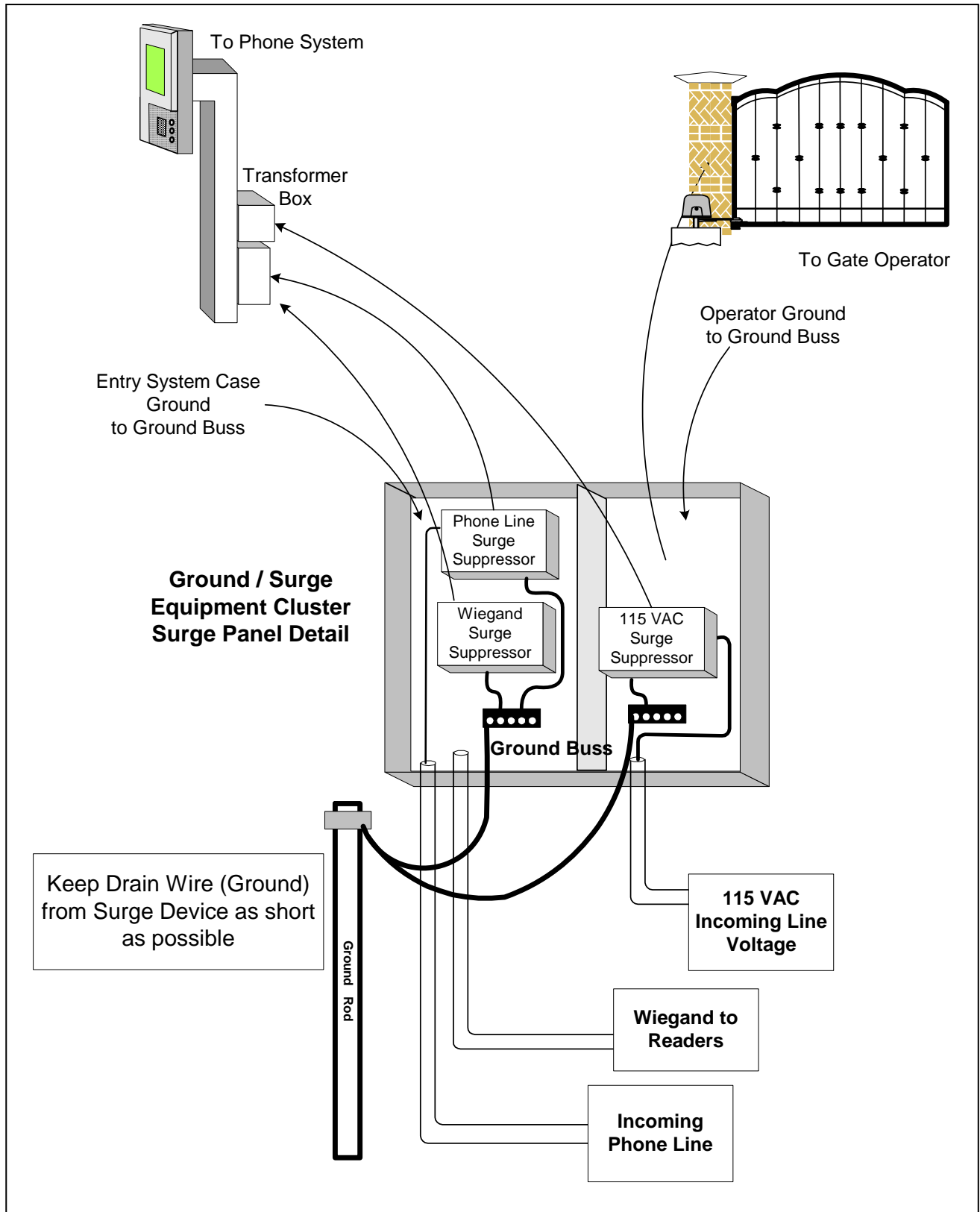

## GROUNDING / SURGE PLAN - OPERATOR AND PHONE SYSTEM

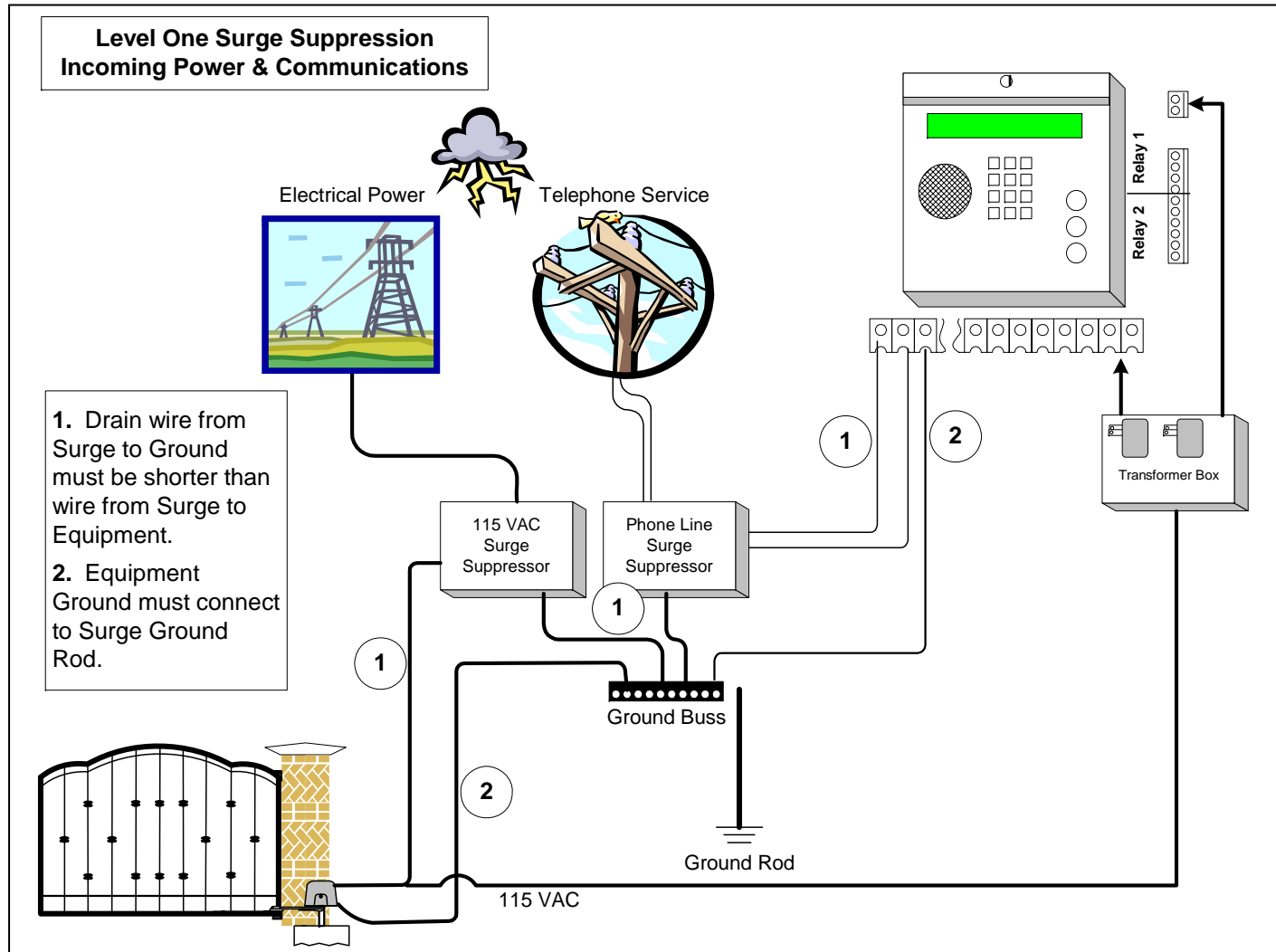



## LIGHTNING SURGE SUPPRESSION - TYPICAL APPLICATIONS

**The Life of a Surge** - When a Power Surge or Lightning Surge enters your system, the Surge Suppression will direct the voltage to Ground. This results in a rise of the value of Ground in the immediate area. **As long as all grounds rise equally, damage is minimized.** However, if some grounds rise farther than other ground values, the surge can move towards the lower value of ground. So what does this mean in a real application? Let's look at a few examples:

**Single Equipment Cluster** - The phone System, Gate Operators and related accessories are all within a close proximity. Create a common termination point for Power, Phone Line and Reader Wiring. Provide a Ground Rod for "Cluster" and locate all Surge Devices at this ground rod. Also connect all Ground Connections to this grounding rod.

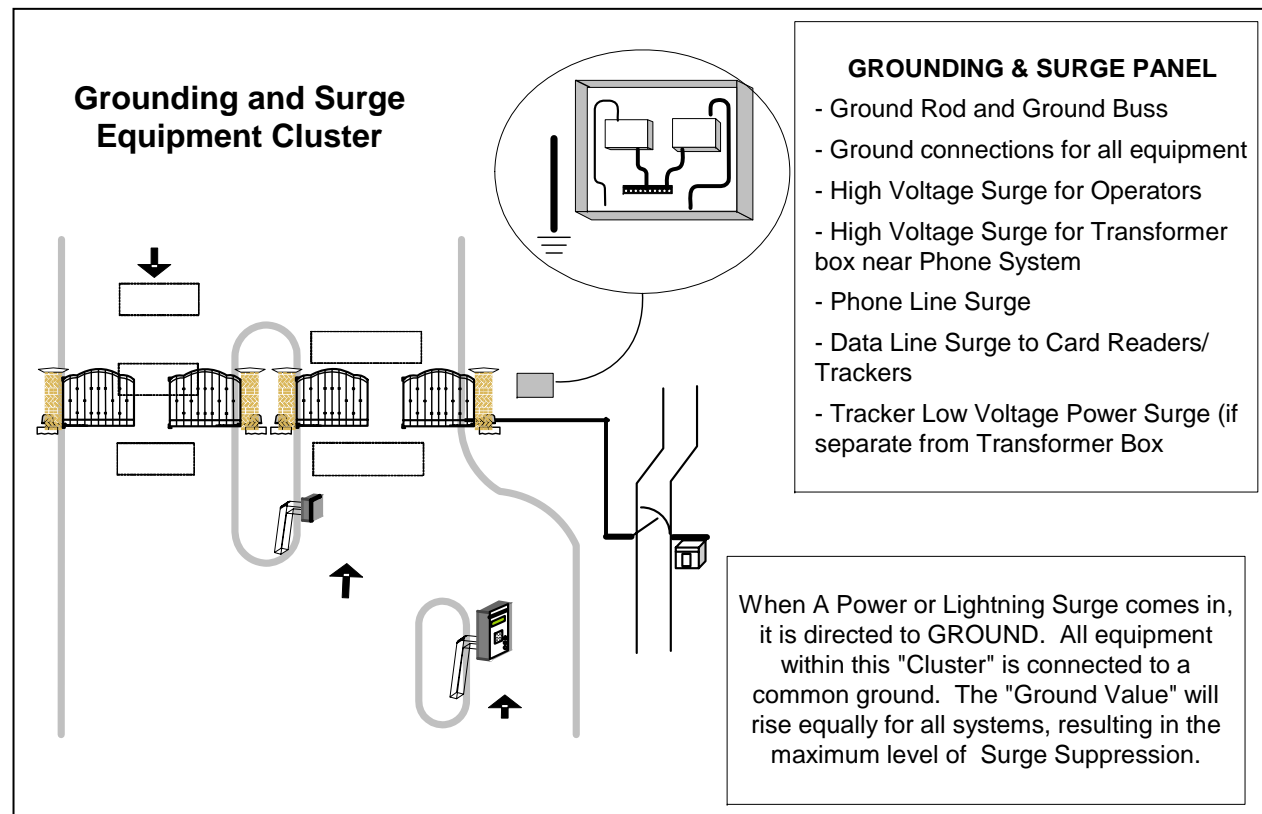

## GROUNDING / SURGE PLAN - OPERATOR, PHONE & READERS

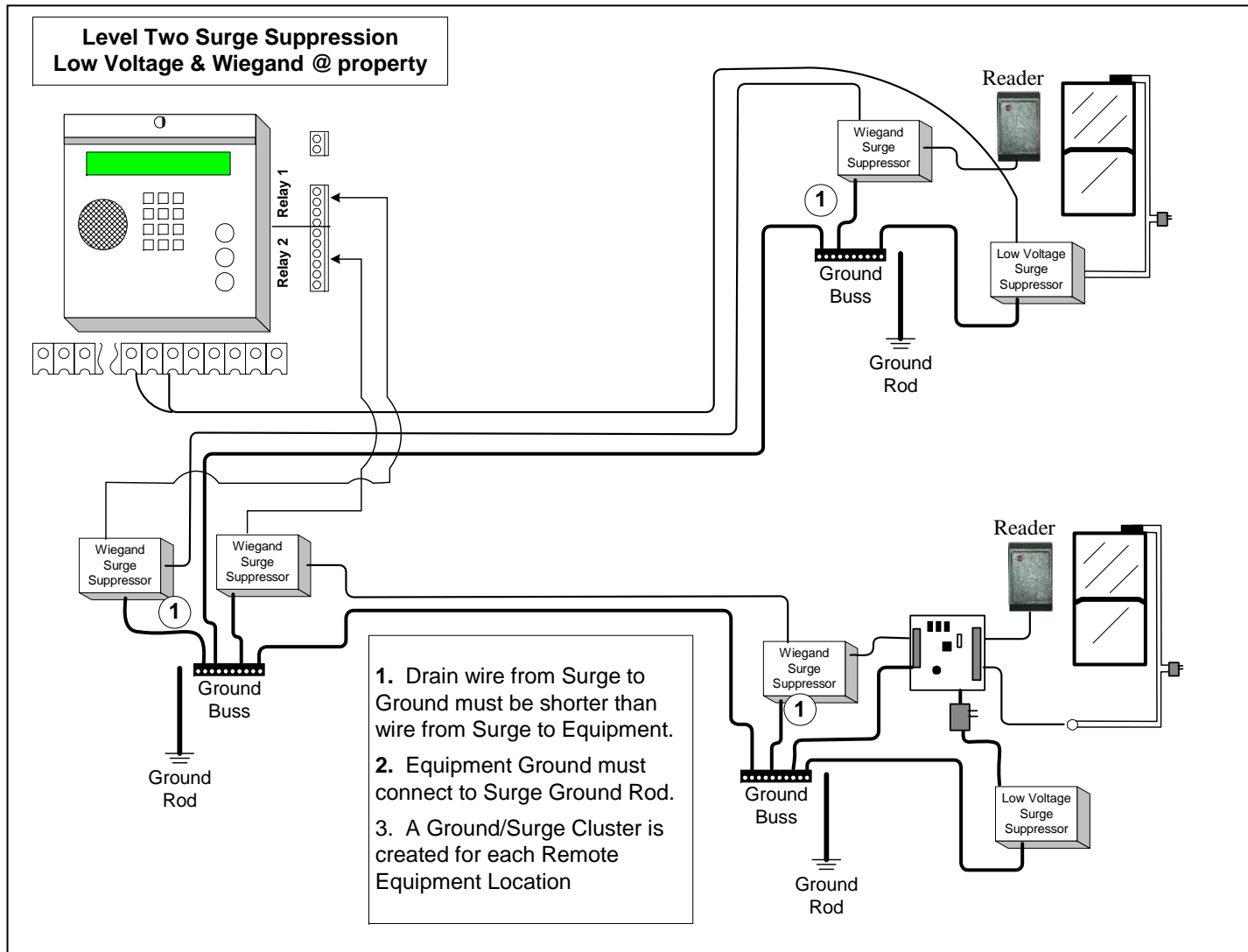

## LIGHTNING SURGE SUPPRESSION - TYPICAL APPLICATIONS

**Remote Devices outside the “Grounding and Surge Cluster”** - If the Remote Reader is connected directly to the Controller (wiegand and power coming from Controller), then this remote reader is, in effect, utilizing the ground from your Entry System “Cluster”. There is no difference in ground between the Reader and the Entry System.

An additional Surge Suppression Device would not be required for the Reader. However, you would have exposure to a Direct or Local Lightning Strike, where a surge would directly affect the line between the Reader and the Controller.

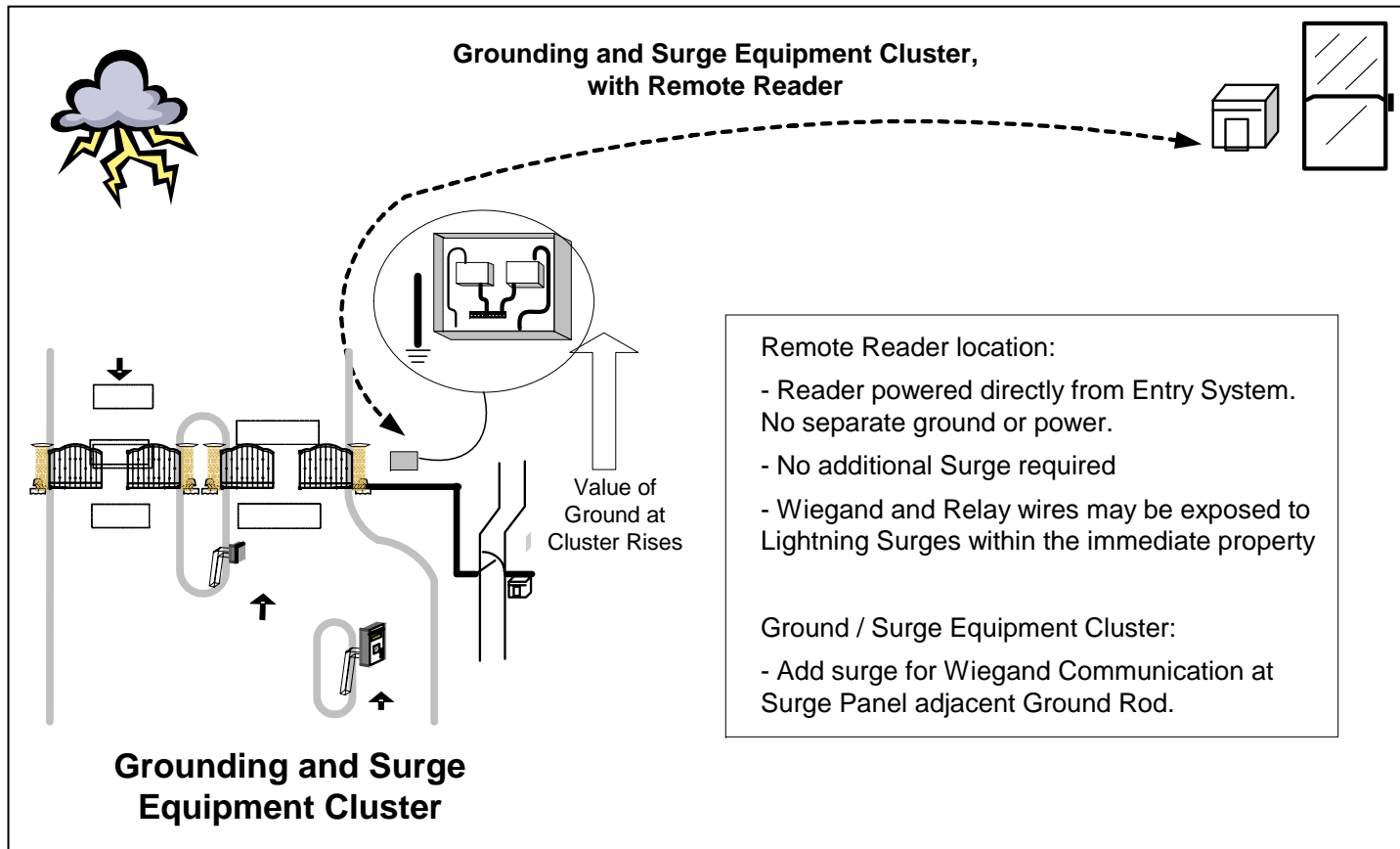

## LIGHTNING SURGE SUPPRESSION - TYPICAL APPLICATIONS

**Remote Devices outside the “Grounding and Surge Cluster”** - If the Remote Reader controlled through a Tracker Board, then the Tracker / Reader combination typically have a separate power source. It is recommended to provide a separate ground for this combination..

When a Surge affects the Entry System “Cluster”, the value of Ground at the Cluster will rise. Ground voltage at the Tracker / Reader may not rise to the same level, resulting in a lower Ground Voltage. The Surge from the Entry System may drain towards the lower value of Ground, resulting in potential damage to the Tracker / Reader. The reverse is also true, a Surge at the Reader may drain towards the Entry System.

Surge Suppression Devices should be installed on the Data (wiegand) line and the power line at the Tracker / Reader Ground point. Again, the suppressors should be located at the Ground Rod, not at the Reader or Tracker .

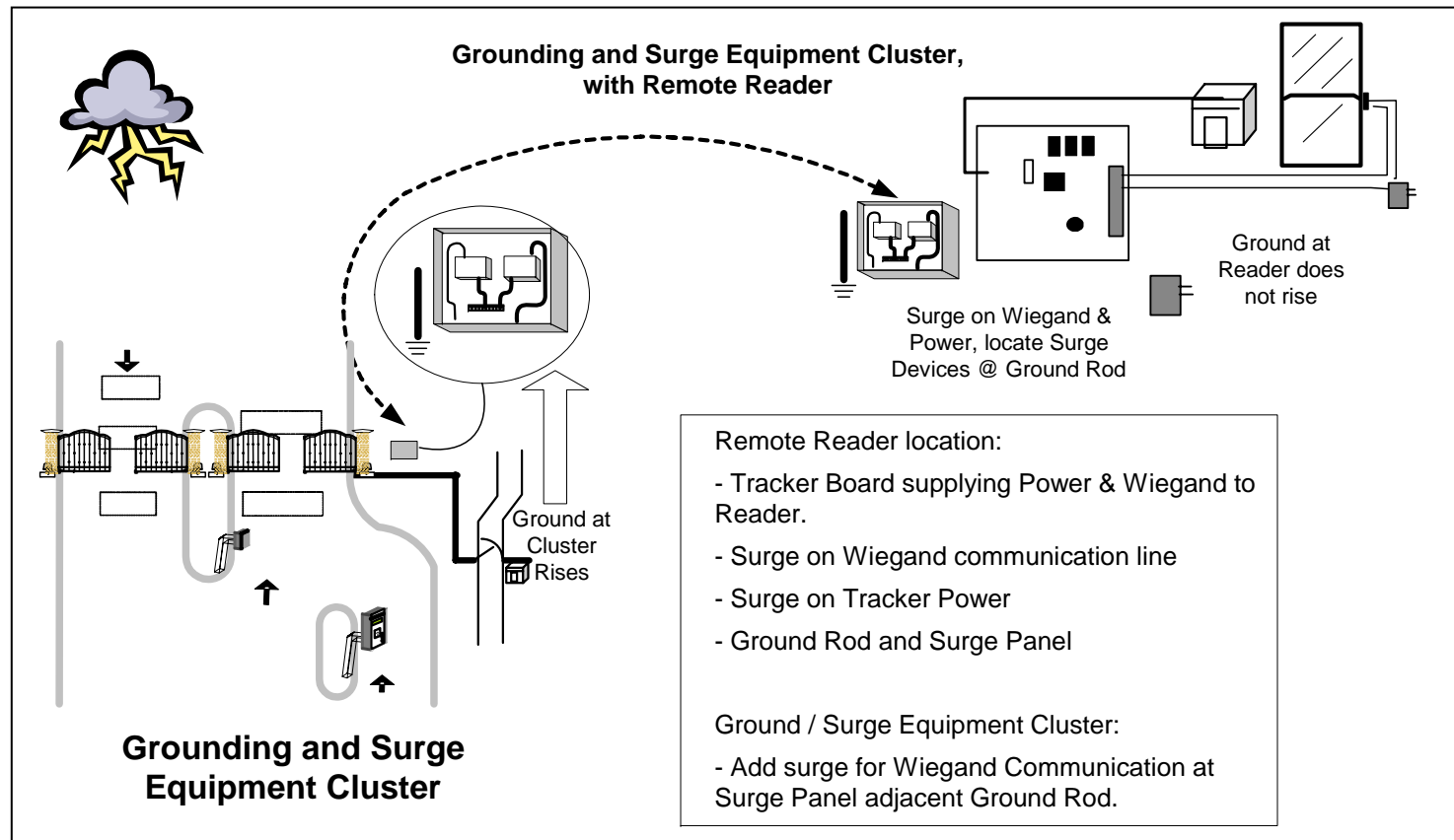

## LIGHTNING SURGE SUPPRESSION

**The Big Picture, A system with multiple Tracker / Reader locations** - In larger systems, you may have multiple Reader and Tracker locations. The same rules apply to these remote equipment locations:

- ❑ Surge Devices should be installed at the Ground Rod or Ground Point
- ❑ Whenever you have a separate Ground, there exists a potential for differences in ground as a Surge is dissipated.
- ❑ Surge should be provided at both ends of a communication line.

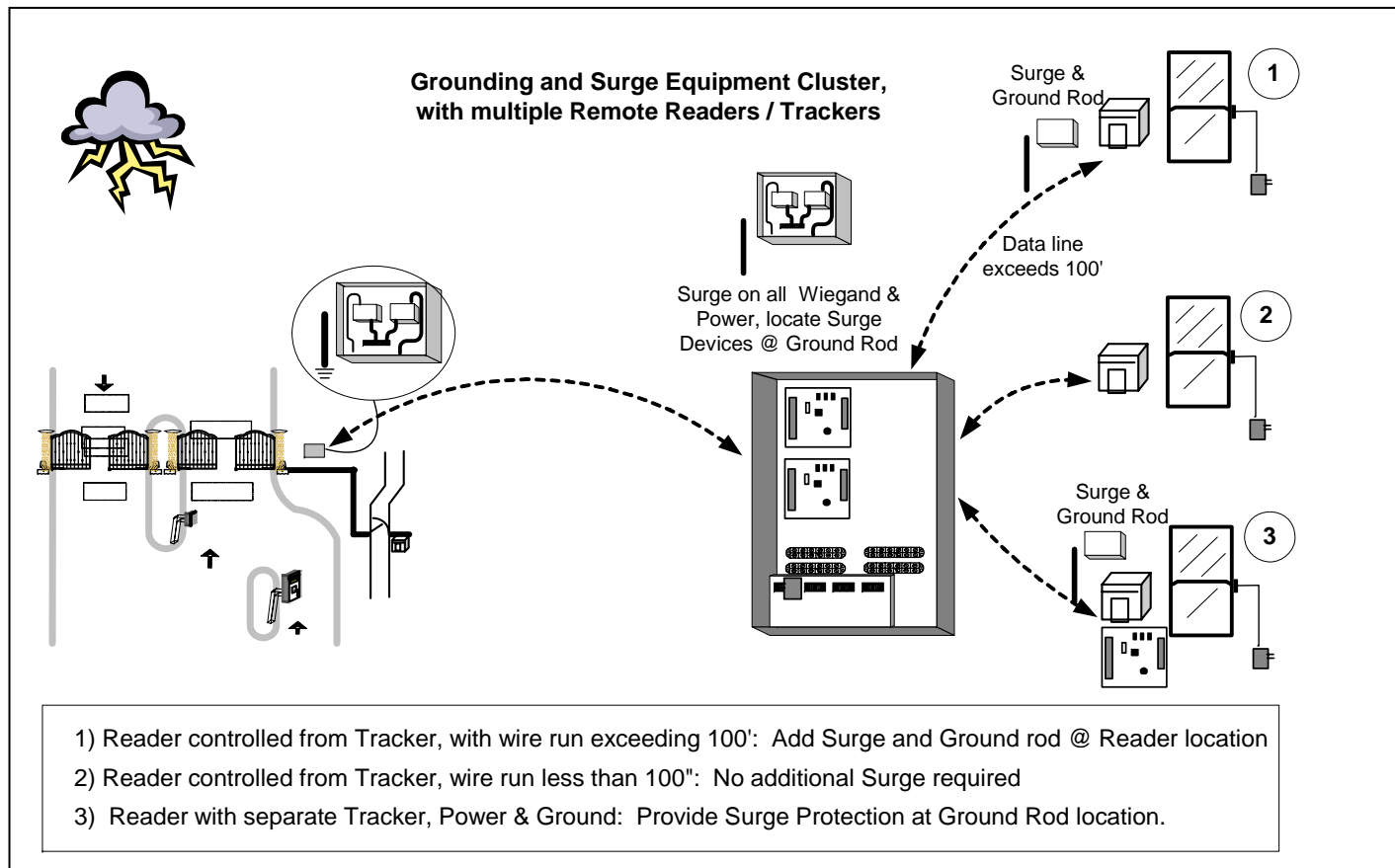



total access control . . .

GROUNDING & SURGE