

EXTERNAL ENTRAPMENT PROTECTION MUST be installed on gate operators or they WILL NOT function.

UL 325 August 2018 Standard

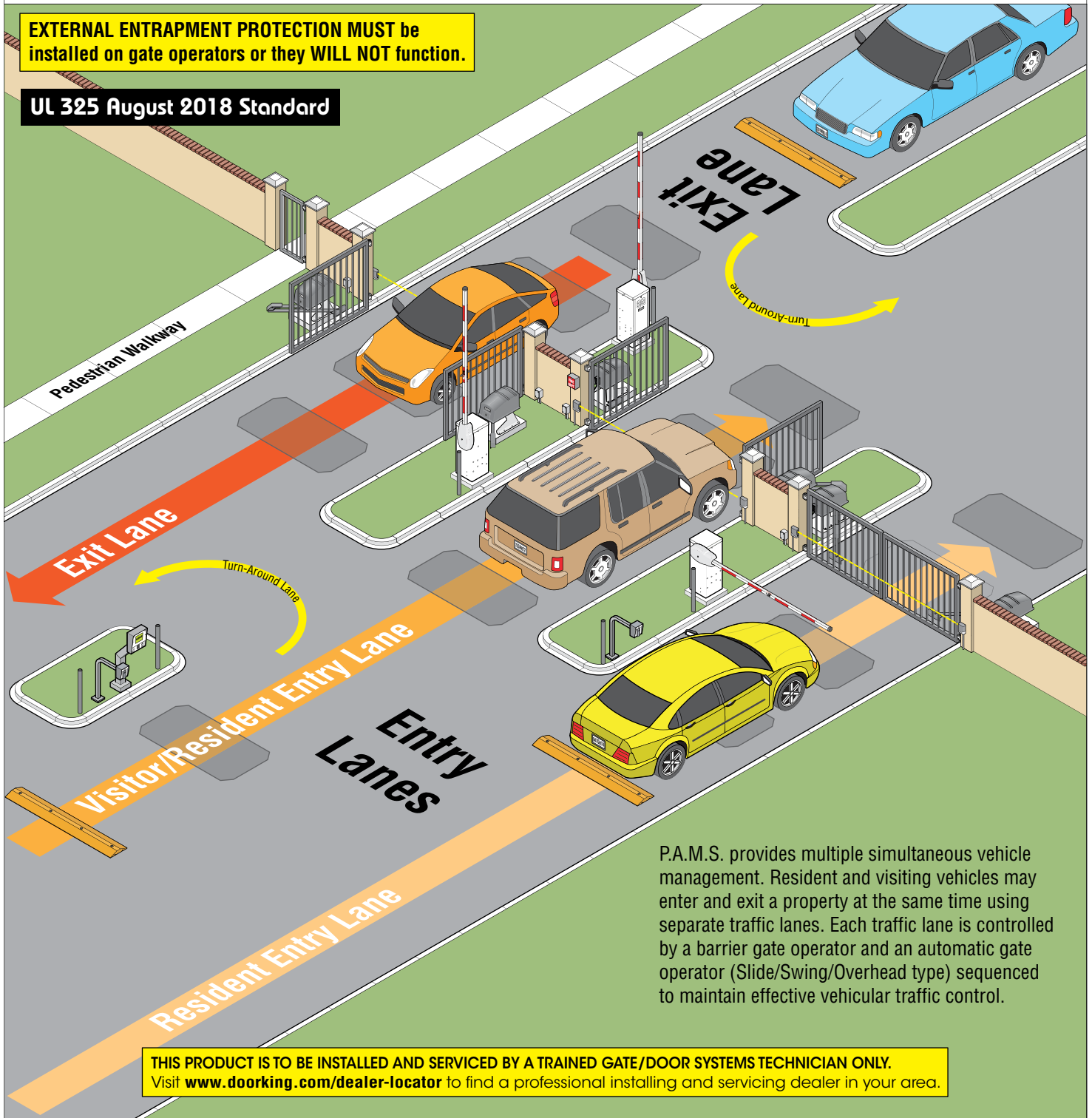

P.A.M.S. provides multiple simultaneous vehicle management. Resident and visiting vehicles may enter and exit a property at the same time using separate traffic lanes. Each traffic lane is controlled by a barrier gate operator and an automatic gate operator (Slide/Swing/Overhead type) sequenced to maintain effective vehicular traffic control.

THIS PRODUCT IS TO BE INSTALLED AND SERVICED BY A TRAINED GATE/DOOR SYSTEMS TECHNICIAN ONLY.
Visit www.doorking.com/dealer-locator to find a professional installing and servicing dealer in your area.

TABLE OF CONTENTS

SECTION 1 - P.A.M.S. SYSTEM OVERVIEW

2

How P.A.M.S. Works	2
P.A.M.S. Gate Operators resident ENTRY Sequence	3
P.A.M.S. Gate Operators EXIT Sequence	4
P.A.M.S. System Arrangements	5

SECTION 2 - TYPICAL SYSTEM LAYOUTS

6

Critical Factors for a 3-Lane Layout	6
Swing Gate - Visitor / Resident Lane Layout	7
Swing Gate - Resident Lane Layout	8
Swing Gate - Exit Lane Layout	9
Swing Gate with 3-Lanes - Typical Equipment List	10
Critical Factors for a 2-Lane Layout	11
Slide Gate - Visitor / Resident Lane Layout	12
Slide Gate - Exit Lane Layout	13
Slide Gate with 2-Lanes - Typical Equipment List	14

SECTION 3 - KEYS FOR MAKING THE SYSTEM WORK

15

1601 Barrier Gate Operator	15
6100 / 6300 Swing Gate Operator	16
6500 Swing Gate Operator	16
6524 Swing / 9024 Slide Gate Operators	16
9000 Slide Gate Operator	17
9100 / 9150 Slide Gate Operator	17
1175 Overhead Gate Operator	17
IMPORTANT: If the Barrier Arm is Broken	18

SECTION 4 - SYSTEM WIRING GUIDELINES

18

6100 / 6300 Swing Gate(s) - Entry Lanes Wiring	19
6100 / 6300 Swing Gate(s) - Exit Lane Wiring	20
6500 Swing Gate(s) - Entry Lanes Wiring	21
6500 Swing Gate(s) - Exit Lane Wiring	22
6524 Swing Gate(s) - Entry Lanes Wiring	23
6524 Swing Gate(s) - Exit Lane Wiring	24
9000 Slide Gate - Entry Lane Wiring	25
9000 Slide Gate - Exit Lane Wiring	26
9024 Slide Gate - Entry Lanes Wiring	27
9024 Slide Gate - Exit Lane Wiring	28
9100 / 9150 Slide Gate - Entry Lane Wiring	29
9100 / 9150 Slide Gate - Exit Lane Wiring	30
1175 Overhead Gate - Entry Lane Wiring	31
1175 Overhead Gate - Exit Lane Wiring	32
Dual 1601 Barrier Gate Operators Wiring - Bi-Parting	33
1601 "ARM UP" will Hold Open Main Gates Wiring	34

SECTION 5 - ADVANCED OPTION, INCREASING TRAFFIC FLOW

35

Override a "DOWN" Command for Barrier Gate Operator	35
---	----

SECTION 6 - TROUBLESHOOTING

36

The Gate Hit My Car	36
Barrier Gate Operator Arm Hits Vehicle	36
Swing / Slide / Overhead Gate Hits Vehicle	36
High Bed Vehicles / Vehicles with Trailers	36

RESIDENT INSTRUCTIONS FOR THE P.A.M.S. SYSTEM

Visitor Access - Telephone Entry System	Resident Training - 1
Resident Access - Access Control Device	Resident Training - 1
Resident Entry Procedure	Resident Training 1-2
Exit Procedure	Resident Training - 2
Advanced Option - Increase Entry Traffic Flow	Resident Training - 3

SECTION 1 - P.A.M.S. SYSTEM OVERVIEW

How P.A.M.S. Works

Effective Control for Vehicular Traffic: The Perimeter Access Management Solutions, or P.A.M.S. for short, is based upon gate operators working in a specific operating sequence, to provide close control of vehicles entering and exiting a property **ONE VEHICLE AT A TIME**. Each traffic lane is controlled by a combination of a barrier gate operator and an automatic gate operator(s) (either a slide, swing or overhead type main gates). The sequencing between these gate operators is a principal factor in controlling vehicular access.

When access has been granted for a vehicle, the phone entry system **OR** access control device will activate the automatic gate operators (Slide/Swing/Overhead). The main gates will open but the barrier gate operator arm will remain in the down position. The authorized vehicle, and any additional vehicles behind it will be held in position. Once the main gates reach the full open position, the barrier gate operator arm will raise to the up position. The first vehicle will pass through the gates. As soon as the first vehicle clears the Down Loop (located beneath the barrier gate operator arm), the arm will **QUICKLY** lower to the down position inhibiting another vehicle from following through (The main gates will remain open). If no other vehicles are present after the initial vehicle has passed through the gate entrance, the main gate's automatic-close timer will count down and close the gates after the programmed hold open time.

If additional vehicles are lined up at this entrance, the Slide/Swing/Overhead main gates will remain open using underground loop sensors. Additional vehicles may activate the phone entry system or access control device and the barrier gate operator arm will cycle up and down **QUICKLY** to allow additional vehicles to enter **ONE VEHICLE AT A TIME**. Once the last vehicle has entered, the barrier gate operator arm will lower first then the main gates will start their closing cycle. Activation of the phone entry system or access control device at this point will stop the main gates from closing and reopen them. Once the gates reach the full open position, the barrier gate operator arm will be raised and the previously described process can continue. See the next 2 pages for specific entry and exit sequences.

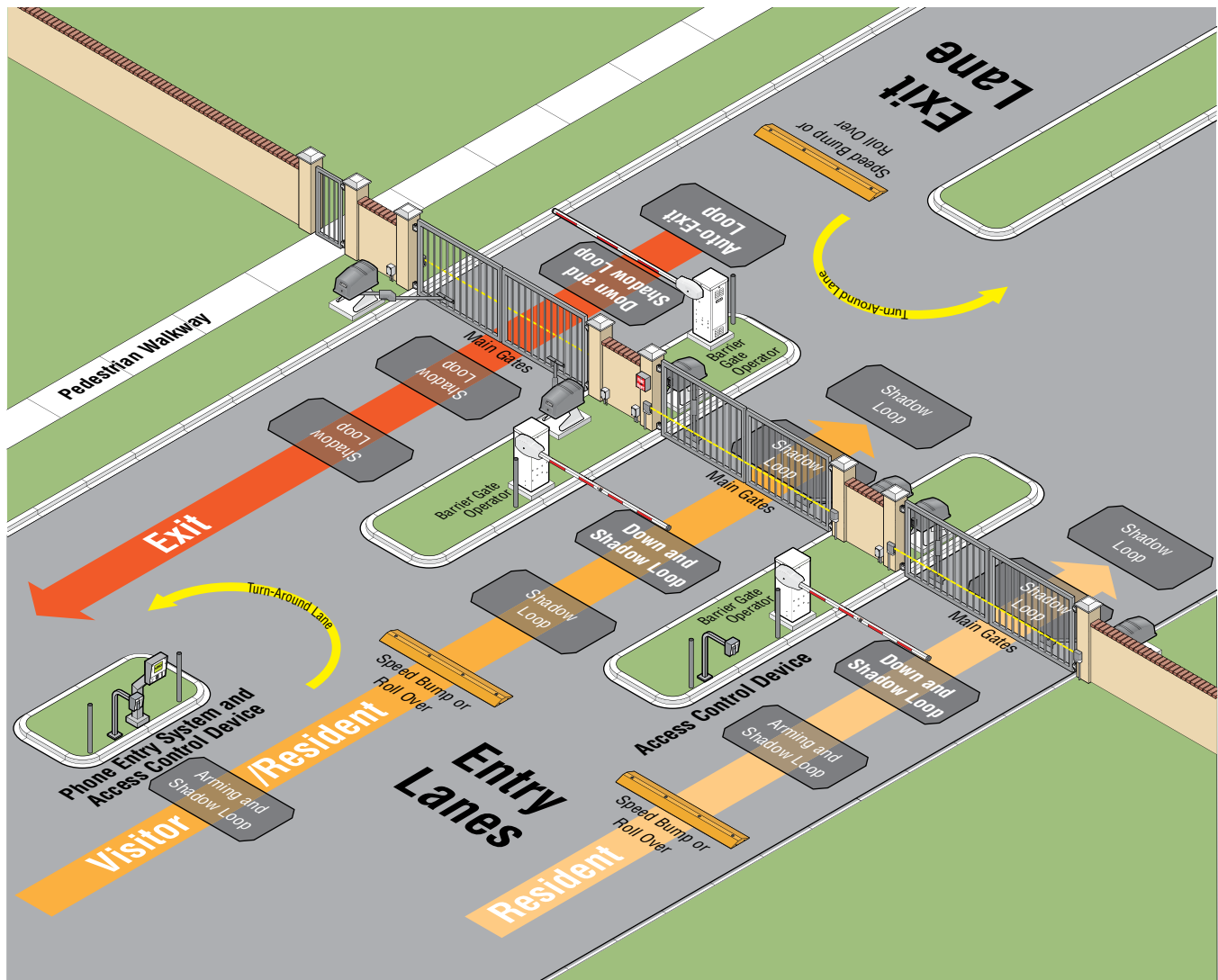

P.A.M.S. Gate Operators Resident ENTRY Sequence

At the heart of the P.A.M.S. concept is the sequencing of the barrier gate operator and the gate operators. This is a principal factor in the effectiveness of this system. The following is an example of the **resident entry** operating sequence in a typical P.A.M.S. set up. The start of this sequence begins with the swing (slide or overhead) gates closed and the barrier gate operator arm in the down position...

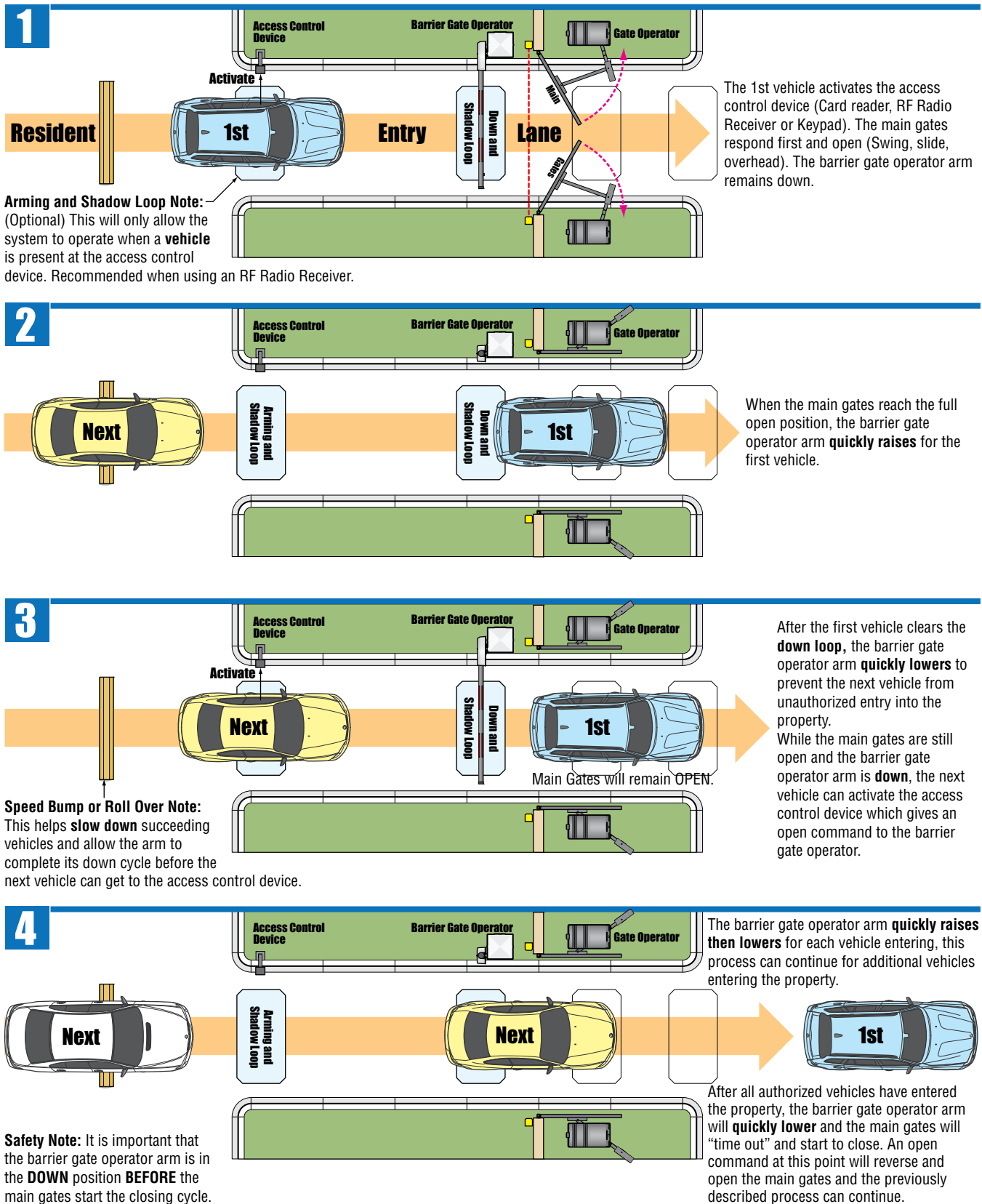

P.A.M.S. Gate Operators EXIT Sequence

At the heart of the P.A.M.S. concept is the sequencing of the barrier gate operator and the gate operators. This is a principal factor in the effectiveness of this system. The following is an example of the exit operating sequence in a typical P.A.M.S. set up. The start of this sequence begins with the swing (slide or overhead) gates closed and the barrier gate operator arm in the down position...

1

The 1st vehicle activates the automatic exit loop. The main gates open first (Swing, slide, overhead). The barrier gate operator arm remains down.

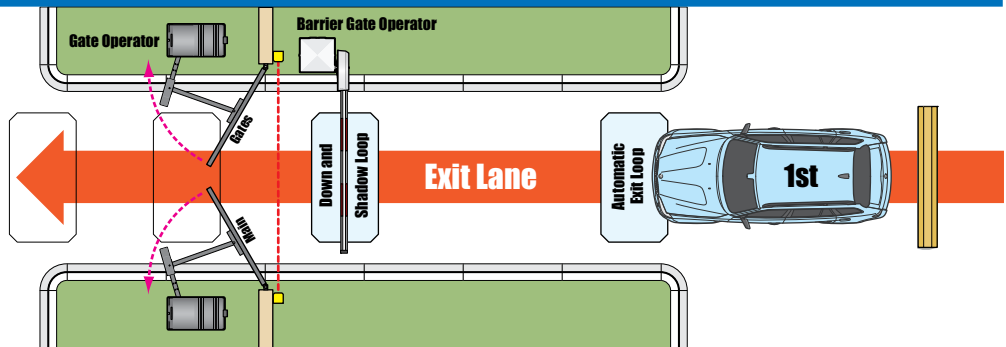

2

When the main gates reach the full open position, the barrier gate operator arm **quickly raises** for the first vehicle.

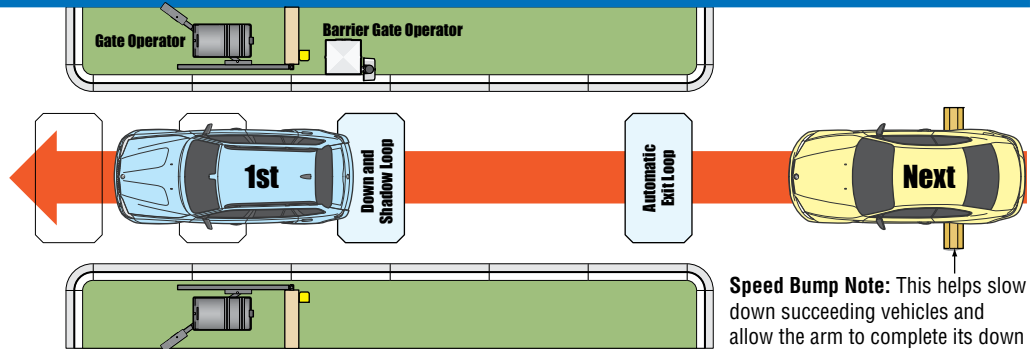

3

After the first vehicle clears the **down loop**, the barrier gate operator arm **quickly lowers**. While the main gates are still open and the barrier gate operator arm is **down**, the next vehicle will activate the automatic exit loop. The arm will **quickly raise** for the next vehicle to exit.

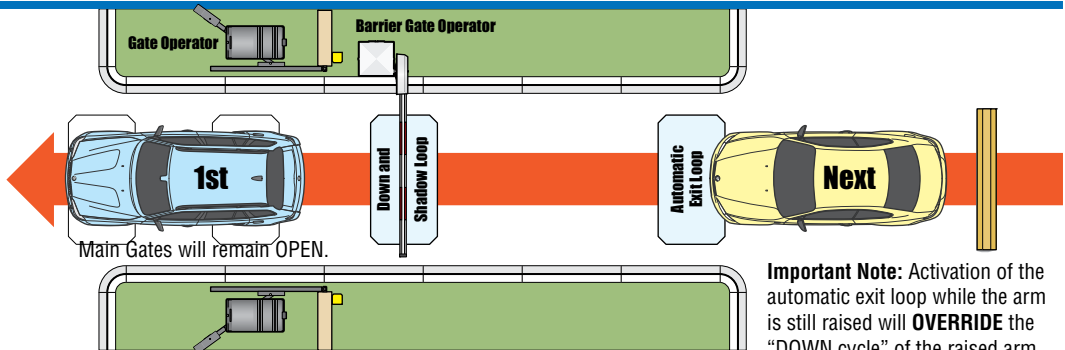

4

The barrier gate operator arm will **quickly lower** and the main gates will "time out" and start to close after all vehicles have exited the property.



An activation of the automatic exit loop at this point will reverse and open the main gates and the previously described process can continue.

Safety Note: It is important that the barrier gate operator arm is in the **DOWN** position **BEFORE** the main gates start the closing cycle.

P.A.M.S. System Arrangements

For the P.A.M.S. concept to provide the best performance, it is **strongly recommended** to utilize a 3-lane layout. This provides an exit lane, a resident entry lane and a combination visitor/resident entry lane. The separate entry lanes are necessary to ensure smooth movement of vehicles during peak traffic periods. DoorKing recommends utilizing the P.A.M.S. set up only in applications where there is sufficient room for separate visitor and resident entry lanes. In applications where only a single entry lane is provided, with a visitor turnout, or where there is room for residents to pass around visitors, DoorKing recommends **against** utilizing the P.A.M.S. system.

Typical 3-Lane (Recommended)

Different combinations of swing/slide/overhead gate operators can be used for each lane. For example, a slide gate operator can be substituted in the exit lane instead of the swing gates that are shown if that would work better for a specific installation. Slide gate operators typically open slower than swing gates which will reduce the traffic flow.

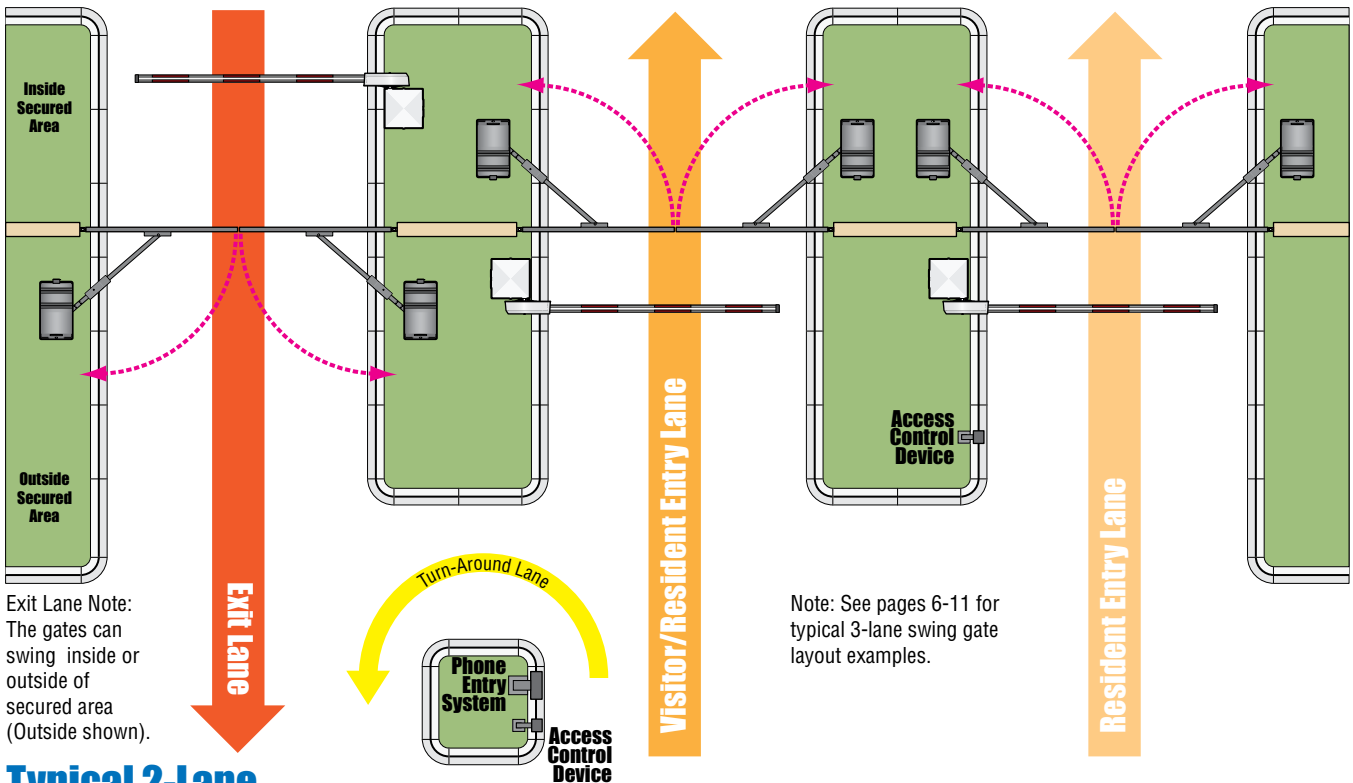

Typical 2-Lane

Different combinations of swing/slide/overhead gate operators can be used for each lane. For example, both lanes can use either swing gates or overhead gates instead of the slide gates that are shown if that would work better for a specific installation. The 2-lane layout will not allow traffic to flow as quickly as a 3-lane layout.

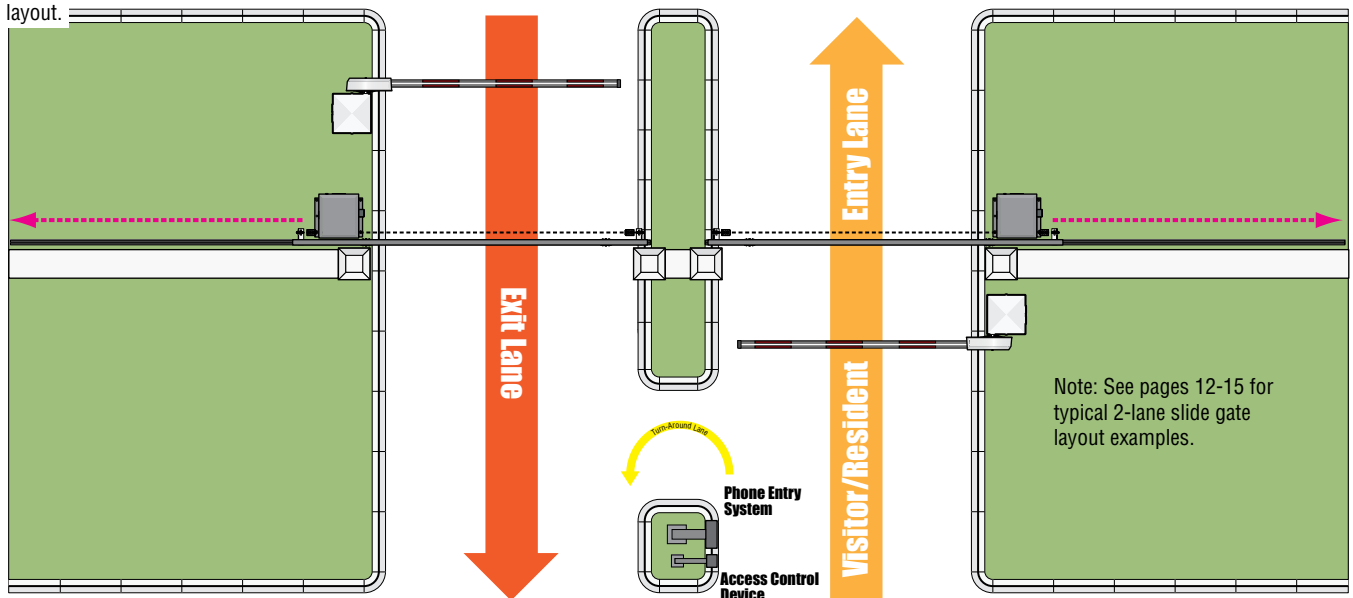

SECTION 2 - TYPICAL SYSTEM LAYOUTS

Critical Factors for a 3-Lane Layout

There is critical equipment and lane layout design specifications that should be adhered to in order for P.A.M.S. to provide optimum performance. These include:

Equipment Placement: Follow the guidelines provided in the lane details pertaining to distances between the main gates and the barrier gate operator, and between the barrier gate operator, access control device (Phone entry system, card reader or keypad) and Speed Bump or Roll Over on the next 4 pages.

Arming and Shadow Loop: (Optional) Does not allow the phone entry system or access control device to initiating the gate cycle sequence unless a vehicle is present at the loop. Recommended when utilizing an RF Receiver (Remote control) for entry. Provides shadow loop function when the main gates are open.

Down and Shadow Loop: Provides down command for the barrier gate operator and provides shadow loop function when the main gates are open.

Automatic Exit Loop: On the exit lane, required to activate the main gates open cycle first, then opens the barrier gate operator arm.

Shadow Loop on the Visitor/Resident Lane: Make sure complete coverage is provided between the phone entry system and the barrier gate operator to keep the system open and operational for slow vehicles.

Speed Bump or Roll Over: Positioned behind the vehicle at the access control device. Helps create a separation between vehicles which allows the barrier gate operator arm to lower between vehicles. Helps prevent unauthorized tailgating vehicles from entering.

Gate Operator Settings: Follow the guidelines for gate operator and barrier gate operator settings, including Auto-Close Timer settings.

External Entrapment Protection - REQUIRED: Gate System should meet standards as defined under ASTM F2200 and 2018 UL 325.

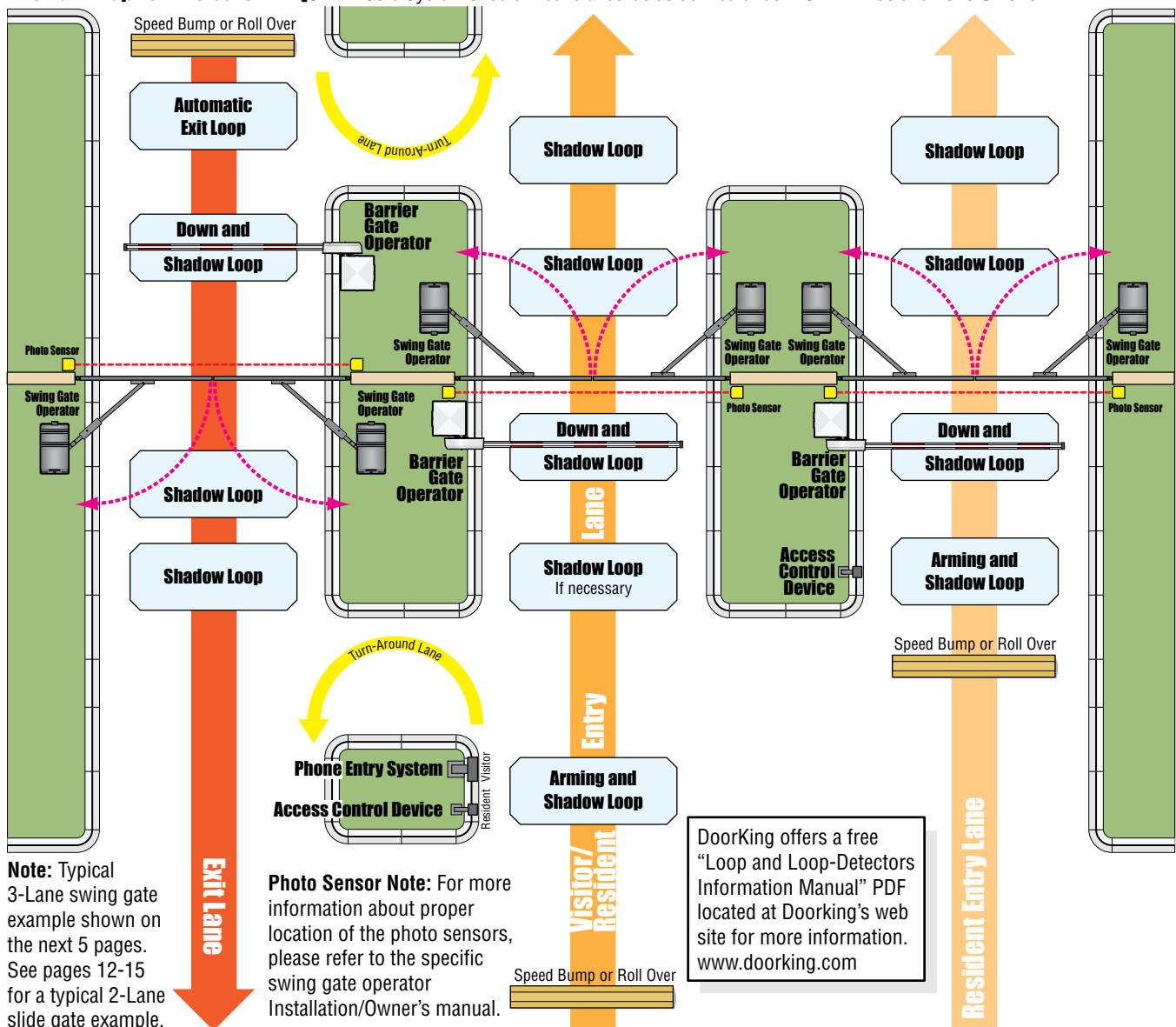

Swing Gate - Visitor/Resident Lane Layout

Gate Operators

Note: For more information about proper location of the gate operators, please refer to the specific swing gate operator Installation/Owner's manual.

Shadow Loop between Barrier Gate Operator and Phone Entry System

System: (Optional) Make sure coverage is provided between the phone entry system and the barrier gate operator to keep the main gates open and operational for slower vehicles if there is a significant distance between the two devices.

Turn-Around Lane:

The distance between the phone entry system island and the operator lane divider island may be affected by local fire codes.

Provide sufficient distance for the turning radius of the turn-around lane.

An additional shadow loop may be required depending on the distance of the turn-around lane.

Arming and Shadow Loop:

(Optional) Ensures that a vehicle is present at the access control devices before access is granted. Also allows the main gates to stay open and operational for lingering vehicles at the access control devices.

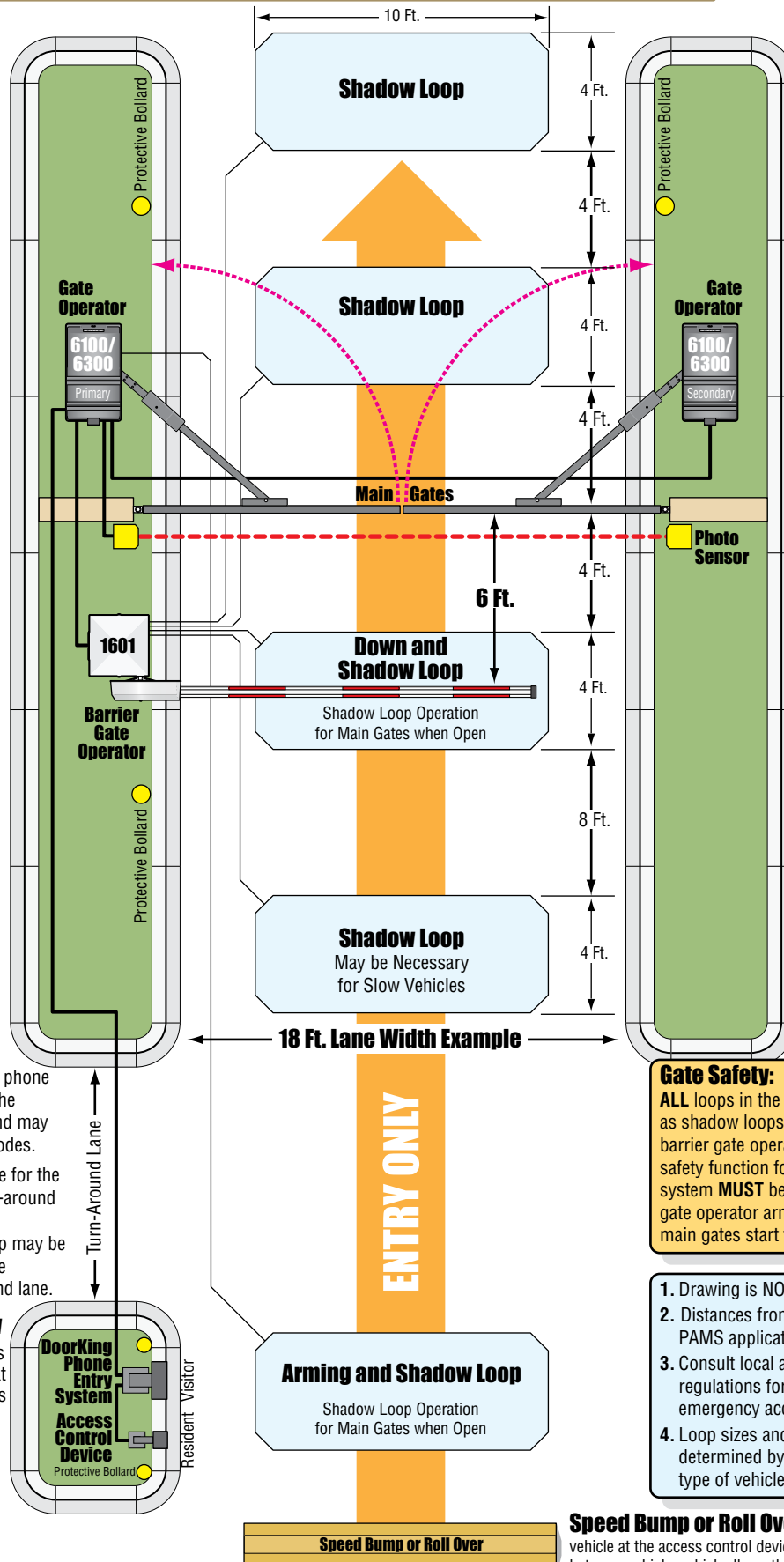

2-Lane Arrangement

Note: If you are using this configuration as the **ONLY** entry lane for a 2-Lane Arrangement, it will slow down entering traffic and is **NOT** recommended for high traffic areas, but may be necessary because of space limitations.

Photo Sensors:

Mounted 5" or less from the gate. Typically mounted 21" high but no more than 27.5" high.

Entrapment Protection must be provided for the gate system where the risk of entrapment or obstruction exists.

The operator **WILL NOT** run without one or more monitored type B1 or B2 entrapment protection devices in **EACH** entrapment area. See specific gate operator manual for more information.

Loop Operation:

All loops function as shadow loops for the main gates. Activation from any loop will **HOLD** the main gates in the **Full Open Position**. However, they **WILL NOT** stop or reverse the main gates once they start to close. The barrier gate operator **ONLY** uses the down loop to control lowering the arm.

Gate Safety:

ALL loops in the P.A.M.S. system operate as shadow loops, **NOT** reverse loops. The barrier gate operator arm provides the safety function for the main gates. The system **MUST** be set to allow the barrier gate operator arm to lower **BEFORE** the main gates start to close.

1. Drawing is NOT to scale.
2. Distances from gate are ideal for PAMS applications.
3. Consult local authorities and applicable regulations for lane dimensions and emergency access requirements.
4. Loop sizes and placement are determined by the lane width and the type of vehicle to be detected.

Speed Bump or Roll Over: Positioned behind the vehicle at the access control device. Helps create a separation between vehicles which allows the barrier gate operator arm to lower between vehicles. Helps prevent unauthorized tailgating vehicles from entering.

Swing Gate - Resident Lane Layout

Gate Operators

Note: For more information about proper location of the gate operators, please refer to the specific swing gate operator Installation/Owner's manual.

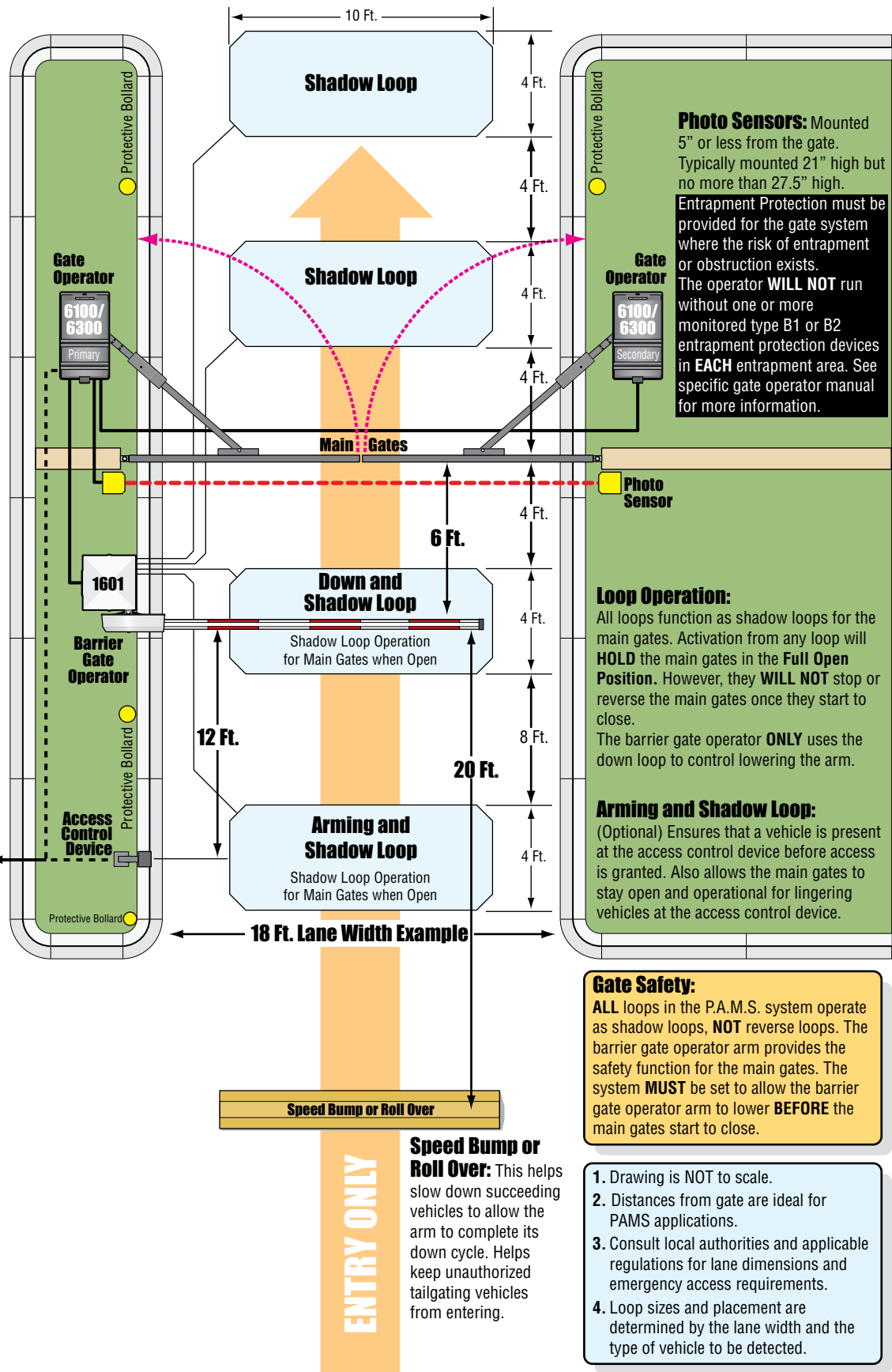

Photo Sensors: Mounted 5" or less from the gate. Typically mounted 21" high but no more than 27.5" high.

Entrapment Protection must be provided for the gate system where the risk of entrapment or obstruction exists. The operator **WILL NOT** run without one or more monitored type B1 or B2 entrapment protection devices in **EACH** entrapment area. See specific gate operator manual for more information.

Loop Operation:

All loops function as shadow loops for the main gates. Activation from any loop will **HOLD** the main gates in the **Full Open Position**. However, they **WILL NOT** stop or reverse the main gates once they start to close. The barrier gate operator **ONLY** uses the down loop to control lowering the arm.

Arming and Shadow Loop:

(Optional) Ensures that a vehicle is present at the access control device before access is granted. Also allows the main gates to stay open and operational for lingering vehicles at the access control device.

Gate Safety:

ALL loops in the P.A.M.S. system operate as shadow loops, **NOT** reverse loops. The barrier gate operator arm provides the safety function for the main gates. The system **MUST** be set to allow the barrier gate operator arm to lower **BEFORE** the main gates start to close.

1. Drawing is NOT to scale.
2. Distances from gate are ideal for PAMS applications.
3. Consult local authorities and applicable regulations for lane dimensions and emergency access requirements.
4. Loop sizes and placement are determined by the lane width and the type of vehicle to be detected.

Speed Bump or Roll Over: This helps slow down succeeding vehicles to allow the arm to complete its down cycle. Helps keep unauthorized tailgating vehicles from entering.

Swing Gate - Exit Lane Layout

Automatic Exit Loop

Automatically opens the gate for exiting vehicles without having to use an access control device. The automatic exit loop can be placed a minimum of 8 feet away from the down loop or far enough away from the main gates so they have started or completely opened by the time the vehicle has driven up to them depending on space limitations (Free exit).

EXIT ONLY

Speed Bump or Roll Over: This helps slow down succeeding exiting vehicles.

Speed Bump or Roll Over

Gate Safety:

ALL loops in the P.A.M.S. system operate as shadow loops, **NOT** reverse loops. The barrier gate operator arm provides the safety function for the main gates. The system **MUST** be set to allow the barrier gate operator arm to lower **BEFORE** the main gates start to close.

1. Drawing is NOT to scale.

2. Distances from gate are ideal for PAMS applications.

3. Consult local authorities and applicable regulations for lane dimensions and emergency access requirements.

4. Loop sizes and placement are determined by the lane width and the type of vehicle to be detected.

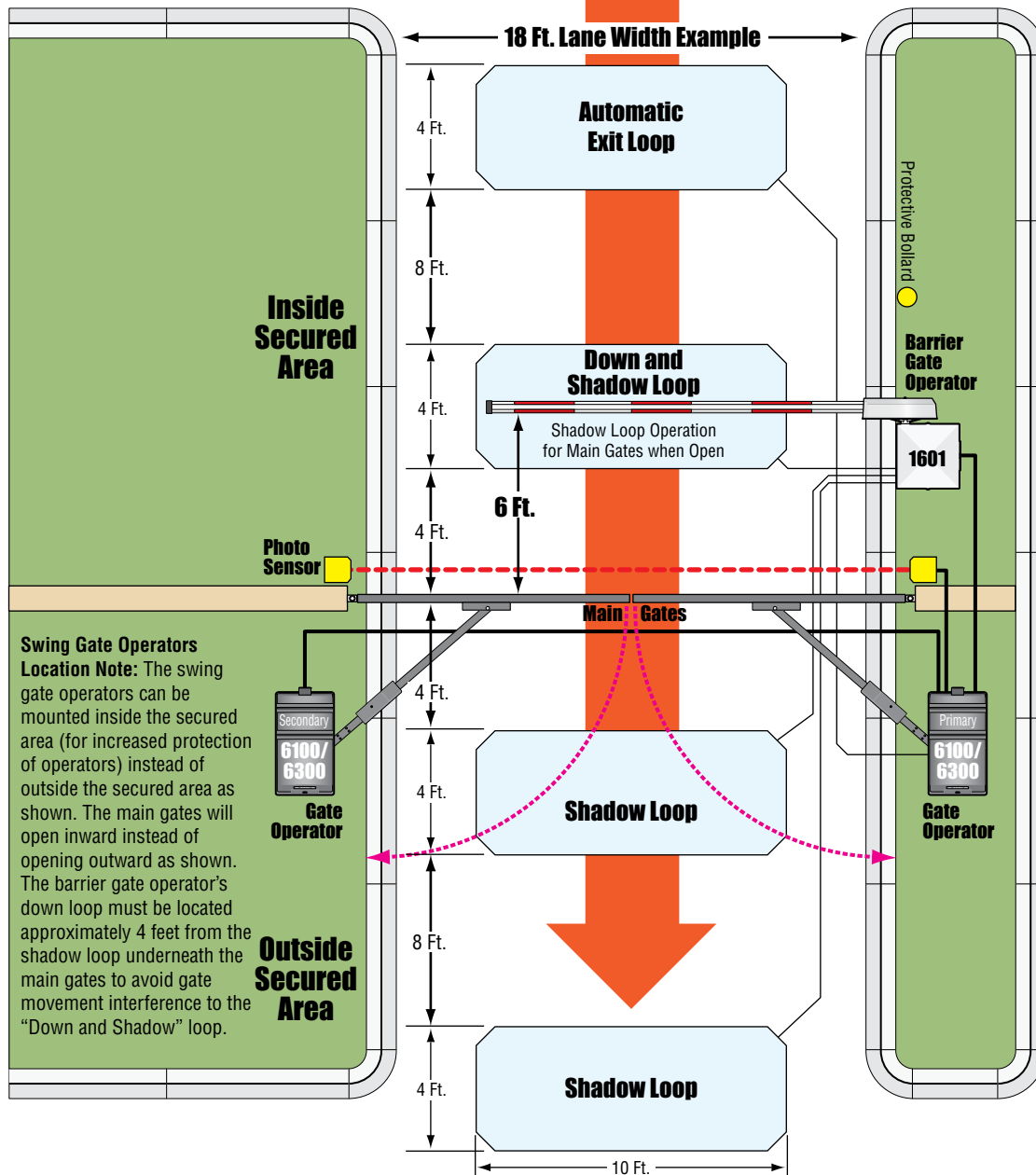

Loop Operation:

Shadow and Down loops function as shadow loops for the main gates. Activation from these loops will **HOLD** the main gates in the **Full Open Position**. However, they **WILL NOT** stop or reverse the main gates once they start to close. The automatic exit loop **WILL** reverse the main gates once they start to close.

The barrier gate operator **ONLY** uses the down loop to control lowering the arm.

Photo Sensors:

Mounted 5" or less from the gate. Typically mounted 21" high but no more than 27.5" high.

Entrapment Protection must be provided for the gate system where the risk of entrapment or obstruction exists.

The operator **WILL NOT** run without one or more monitored type B1 or B2 entrapment protection devices in **EACH** entrapment area. See specific gate operator manual for more information.

Gate Operators

Note: For more information about proper location of the gate operators, please refer to the specific swing gate operator Installation/Owner's manual.

Swing Gate with 3-Lanes - Typical Equipment List

Please note that there are many options available when configuring the P.A.M.S. Gate System. These options include: Battery Back-up for All Gate Operators, Gate Operator Mounting Kits, Barrier Gate Operator Arm Styles, Access Control Device Options.

Equipment	Part Number	Quantity
Gates:		
Bi-parting Vehicular Iron Swing Gates _____	(by outside contractor)	3 sets
DoorKing Sealed Bearing Gate Hinges _____	1200-019	12
Gate Operators:		
DoorKing Commercial 6100 Swing Gate Operator, ½ hp Primary _____	6100-380	3
DoorKing Commercial 6100 Swing Gate Operator, ½ hp Secondary _____	6100-381	3
DoorKing 6100 Swing Gate Accessory Kit, Pad Mount (Post mount kit also available P/N 2600-674) _____	2600-691	6
} 6100		
DoorKing Commercial 6300 Swing Gate Operator, 1 hp Primary _____	6300-384	3
DoorKing Commercial 6300 Swing Gate Operator, 1 hp Secondary _____	6300-385	3
DoorKing 6300 Swing Gate Accessory Kit, Pad Mount (Post mount kit also available P/N 2600-263) _____	2600-264	6
} 6300		
DoorKing Commercial 6500 Swing Gate Operator, ½ hp Primary _____	6500-380	3
DoorKing Commercial 6500 Swing Gate Operator, ½ hp Secondary _____	6500-381	3
} 6500		
DoorKing Barrier Gate Operator _____	1601-080	3
DoorKing Standard Aluminum Arm Hardware Kit _____	1601-242	3
DoorKing Standard Aluminum Arm - 14 ft. _____	1601-216	3
Arm Options DoorKing Lighted Aluminum Arm Hardware Kit _____	1601-535	3
DoorKing Lighted Aluminum Arm - 14 ft. _____	1601-518	3
Arm Note: DoorKing also manufactures Wood and PVC arms for the 1601 Barrier Gate Operator		
DoorKing Interconnection Cable - 30 Ft. - P/N 2600-755, 40 Ft. - P/N 2600-756, 50 Ft. - P/N 2600-757		
Interconnection Cable Note: Cable between primary and secondary gate operator for each lane.		
Loops:		
DoorKing Digital Plug-In Loop Detector 2-Channel (Down Loops and Shadow Loops) _____	9409-010	3
DoorKing Digital External Loop Detector 2-Relays (and Wire Harness P/N 9402-061) _____	9402-047	3
External Detector Note: Arming/Shadow Loop at Phone Entry System and Access Control Device		
DoorKing Underground Loop Wire (XLPE) Black _____	9402-077	1000'
DoorKing Underground Loop Wire (XLPE) Blue _____	9402-079	1000'
Safety: Entrapment protection MUST be provided for the gate system where the risk of entrapment or obstruction exists. The operator WILL NOT run without one or more monitored type B1 or B2 entrapment protection devices in EACH entrapment area. See specific gate operator Installation/Owner's manual for more information.		
Monitored Photo Sensor Options: Available for type B1 entrapment protection. See your specific gate operator manual for more information and part numbers for devices.		
		qty varies
Monitored Edge Sensor Options: Available for type B2 entrapment protection. See your specific gate operator manual for more information and part numbers for devices.		
DoorKing Speed Bump - Mount on a concrete surface Only _____	1610-150	3
Access Control Devices:		
DoorKing PC Programmable Phone Entry System options _____	or 1835-090 1837-090	1
Phone Entry Note: DoorKing has various phone entry systems available for any specific needs.		
DoorKing Architectural series Gooseneck Mounting Post (For Phone Entry System) _____	1200-038	1
DoorKing Proximity Card Reader in lighted housing (For Visitor/Resident and Resident Entry Lanes) _____	1815-230	2 when used
DoorKing Prox Cards (Typically 2 per household) _____	1508-110	qty varies
Card Reader Note: DoorKing has various card reader models available.		
DoorKing Gooseneck Mounting Post (For Card Readers or Digital Keypads) _____	1200-046	2
DoorKing Wiegand RF Receiver (For Visitor/Resident and Resident Entry Lanes) _____	8040-080	2 when used
DoorKing MicroPLUS RF Transmitters (Typically 2 per household) _____	8069-080	qty varies
DoorKing Weigand Digital Keypad in lighted housing (For Visitor/Resident and Resident Entry Lanes) _____	1815-051	2 when used
Emergency Access Devices:		
Emergency Access Devices as required by local codes (check local codes for compliance).		
Fire Department Lock Box (accepts Knox 3501 Key Switch provided by other) _____	1401-080	as needed

Pedestrian Entrance Note: There **MUST** be a **SEPARATE** entrance for pedestrians installed **AWAY** from the vehicular gates.

Critical Factors for a 2-Lane Layout

There is critical equipment and lane layout design specifications that should be adhered to in order for P.A.M.S. to provide optimum performance. These include:

Equipment Placement: Follow the guidelines provided in the lane details pertaining to distances between the main gate and the barrier gate operator, and between the barrier gate operator, access control device (Phone entry system, card reader or keypad) and Speed Bump or Roll Over on the next 2 pages.

Arming and Shadow Loop: (Optional) Does not allow the phone entry system or access control device to initiating the gate cycle sequence unless a vehicle is present at the loop. Recommended when utilizing an RF Receiver (Remote control) for entry. Provides shadow loop function when the main gates are open.

Down and Shadow Loop: Provides down command for the barrier gate operator and provides shadow loop function when the main gates are open.

Automatic Exit Loop: On the exit lane, required to activate the main gates open cycle first, then opens the barrier gate operator arm.

Shadow Loop on the Visitor/Resident Lane: Make sure complete coverage is provided between the phone entry system and the barrier gate operator to keep the system open and operational for slow vehicles.

Speed Bump or Roll Over: Positioned behind the vehicle at the access control device. Helps create a separation between vehicles which allows the barrier gate operator arm to lower between vehicles. Helps prevent unauthorized tailgating vehicles from entering.

Gate Operator Settings: Follow the guidelines for gate operator and barrier gate operator settings, including Auto-Close Timer settings.

External Entrapment Protection - REQUIRED: Gate System should meet standards as defined under ASTM F2200 and 2018 UL 325.

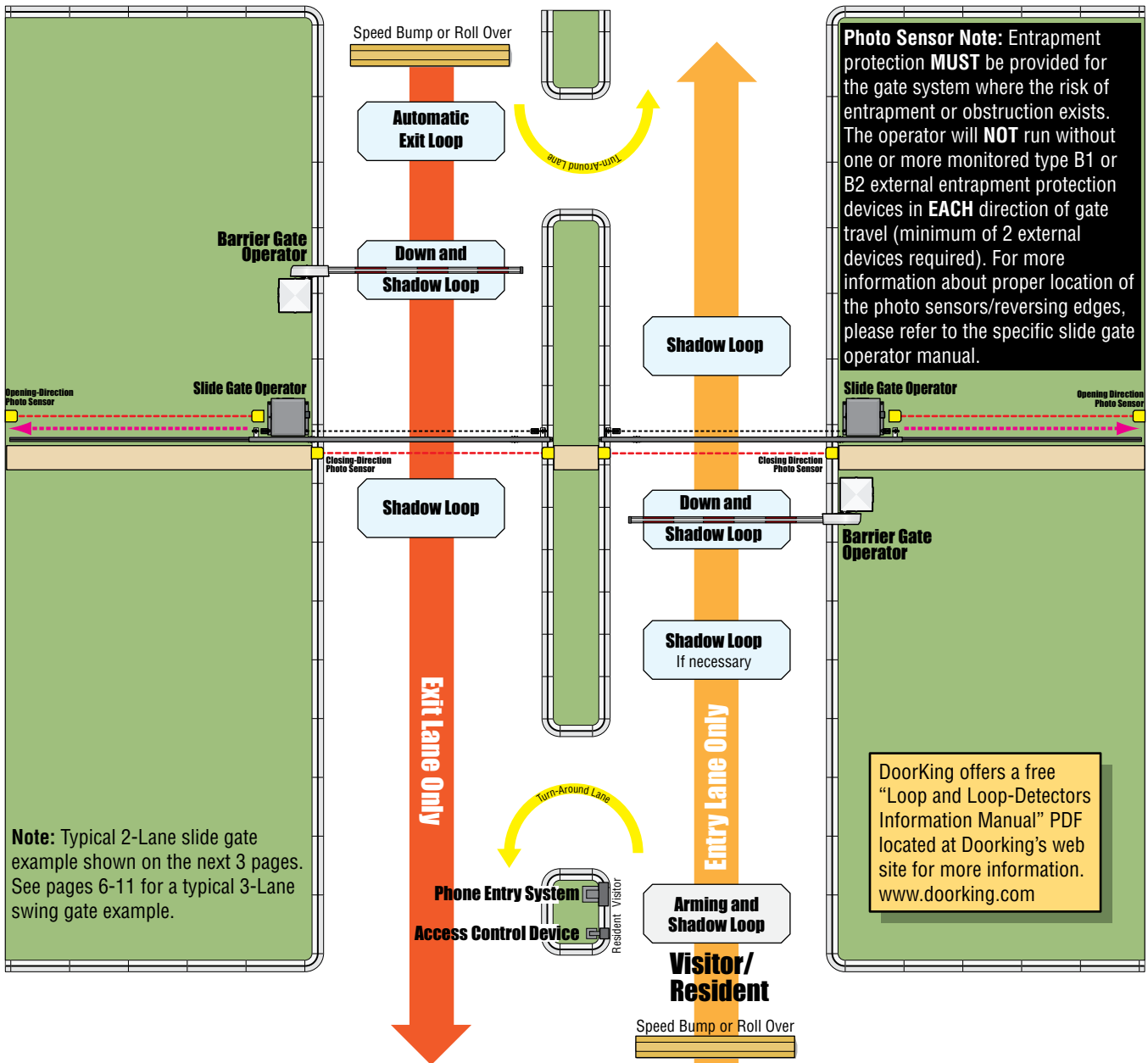

Slide Gate - Visitor/Resident Lane Layout

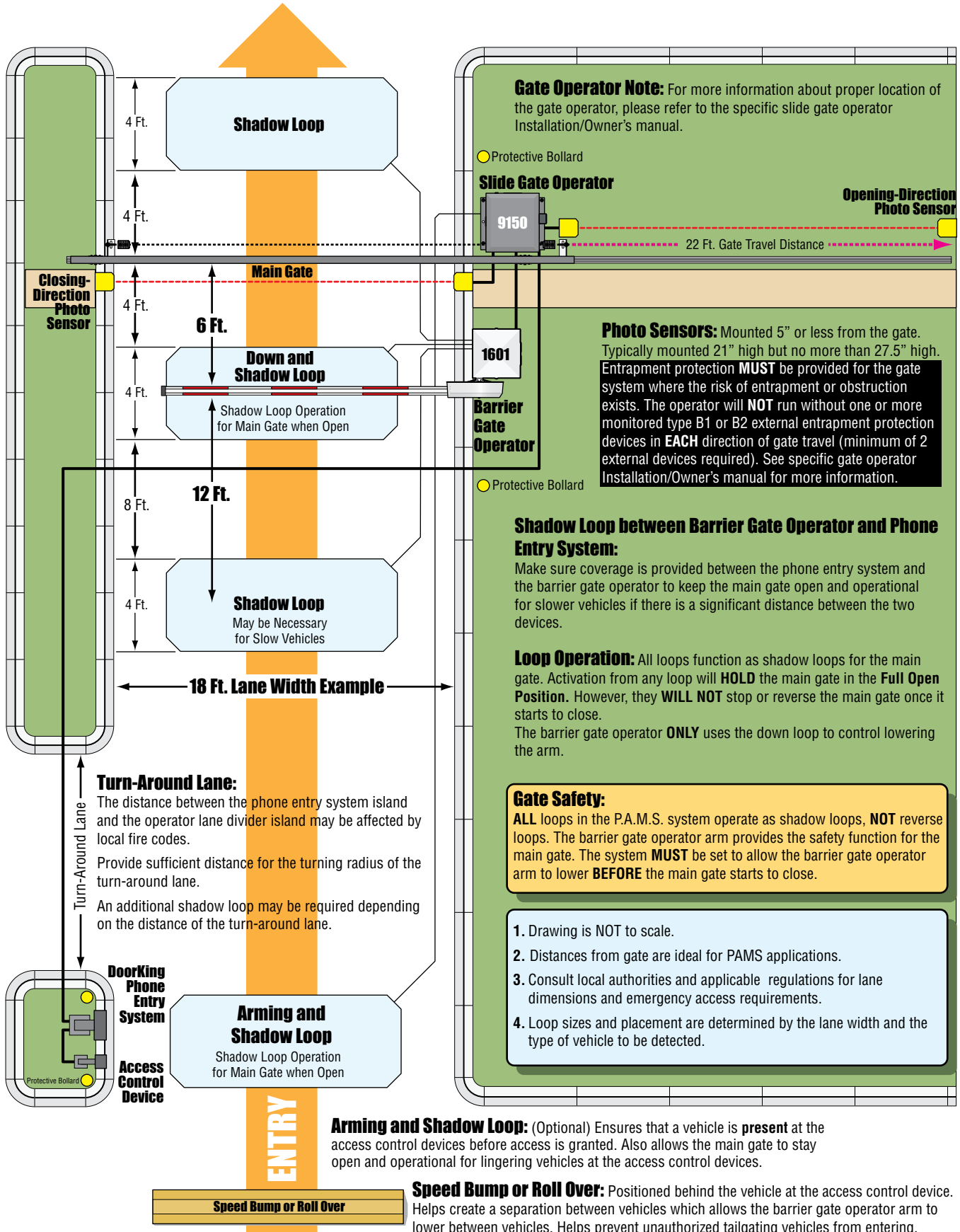

Slide Gate - Exit Lane Layout

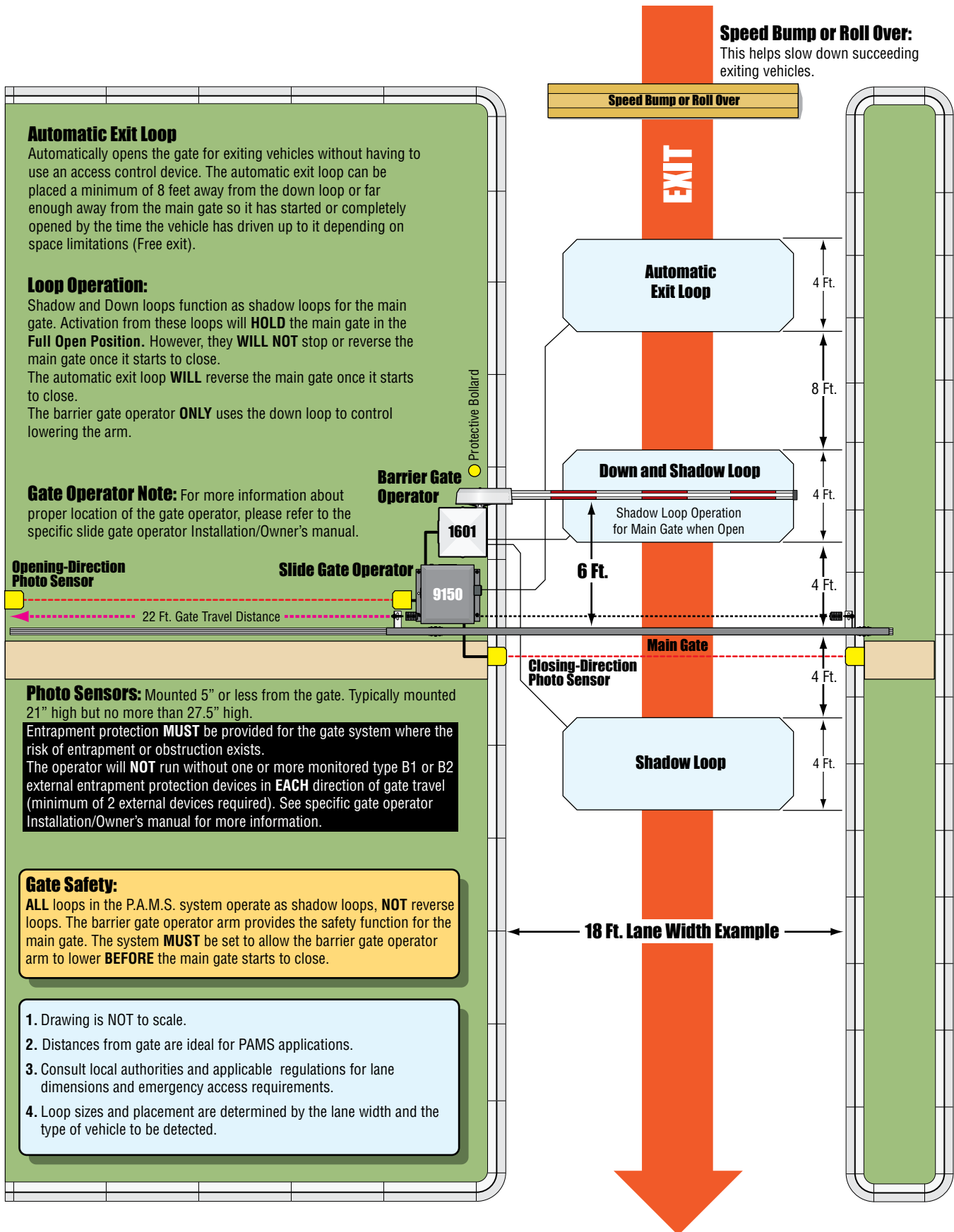

Slide Gate with 2-Lanes - Typical Equipment List

Please note that there are many options available when configuring the P.A.M.S. Gate System. These options include: Battery Back-up for All Gate Operators, Gate Operator Mounting Kits, Barrier Gate Operator Arm Styles, Access Control Device Options.

Equipment	Part Number	Quantity
Gates:		
Vehicular Iron Slide Gate (2" Gate Frame)	(by outside contractor)	2
DoorKing Machined 4" Steel V-Wheel Assembly (Fits on a 2" Gate Frame)	1201-117	4
DoorKing Guarded Guide Rollers, 3" Double Rollers (Guides a 2" Gate Frame)	1204-122	2
Gate Operators:		
DoorKing Commercial 9000 Slide Gate Operator, ½ hp	9000-380	2 when used
DoorKing Commercial 9100 Slide Gate Operator, ½ hp	9100-380	2 when used
DoorKing Commercial 9150 Slide Gate Operator, ½ hp	9150-384	2 when used
DoorKing Barrier Gate Operator	1601-080	2
DoorKing Standard Aluminum Arm Hardware Kit	1601-242	2
Arm [DoorKing Standard Aluminum Arm - 14 ft.	1601-216	2
Options [DoorKing Lighted Aluminum Arm Hardware Kit	1601-535	2
[DoorKing Lighted Aluminum Arm - 14 ft.	1601-518	2
Arm Note: DoorKing also manufactures Wood and PVC arms for the 1601 Barrier Gate Operator		
DoorKing Interconnection Cable - 30 Ft. - P/N 2600-755, 40 Ft. - P/N 2600-756, 50 Ft. - P/N 2600-757		
Interconnection Cable Note: Cable between gate operator and barrier gate operator for each lane.		
Loops:		
DoorKing Digital Plug-In Loop Detector 2-Channel (Down Loops and Shadow Loops)	9409-010	2
DoorKing Digital External Loop Detector 2-Relays (and Wire Harness P/N 9402-061)	9410-047	2
External Detector Note: Including Arming/Shadow Loop at Phone Entry System		
DoorKing Underground Loop Wire (XLPE) Black	9402-077	1000'
DoorKing Underground Loop Wire (XLPE) Blue	9402-079	1000'
Safety: Entrapment protection MUST be provided for the gate system where the risk of entrapment or obstruction exists. The operator WILL NOT run without one or more monitored type B1 or B2 entrapment protection devices in EACH direction of gate travel (Minimum of 2 external devices required). See specific gate operator Installation/Owner's manual for more information.		
Monitored Photo Sensor Options: Available for type B1 entrapment protection. See your specific gate operator manual for more information and part numbers for devices.		qty varies
Monitored Edge Sensor Options: Available for type B2 entrapment protection. See your specific gate operator manual for more information and part numbers for devices.		
DoorKing Speed Bump - Mount on a concrete surface Only	1610-150	2
Access Control Devices:		
DoorKing PC Programmable Phone Entry System options	or 1835-090 1837-090	1
Phone Entry Note: DoorKing has various phone entry systems available for any specific needs.		
DoorKing Architectural series Gooseneck Mounting Post (For Phone Entry System)	1200-038	1
DoorKing Proximity Card Reader in lighted housing	1815-230	1 when used
DoorKing Prox Cards (Typically 2 per household)	1508-110	qty varies
Card Reader Note: DoorKing has various card reader models available, including touch plate readers and proximity readers.		
DoorKing Gooseneck Mounting Post (For Card Readers or Digital Keypads)	1200-046	1
DoorKing Wiegand RF Receiver	8040-080	1 when used
DoorKing MicroPLUS RF Transmitters (Typically 2 per household)	8069-080	qty varies
DoorKing Wiegand Digital Keypad in lighted housing	1815-051	1 when used
Emergency Access Devices:		
Emergency Access Devices as required by local codes (check local codes for compliance).		
Fire Department Lock Box (accepts Knox 3501 Key Switch provided by other)	1401-080	as needed

Pedestrian Entrance Note: There **MUST** be a **SEPARATE** entrance for pedestrians installed **AWAY** from the vehicular gates.

SECTION 3 - KEYS FOR MAKING P.A.M.S. WORK

The DoorKing Perimeter Access Control Solution, or P.A.M.S., has proven to be very effective at controlling vehicular traffic and limiting access to **one vehicle at a time**. The key to the success of our P.A.M.S. concept is how we sequence the operation of the Barrier Gate Operator with the Swing/Slide/Overhead Gate Operator.

This special gate sequencing is accomplished by utilizing some special features found in DoorKing Gate Operators.

1601 Barrier Gate Operator

Special inputs on this operator provide specifically designed functions, which help make the P.A.M.S. configuration work.

Momentary Up Input - Terminal #10: This input provides two important functions:

- An input provided to terminal #10 will function as a “**One Time UP**” Command to the operator, raising the barrier arm. Once the arm reaches the UP position, any down command will lower the arm, even though the operator is still receiving a contact on terminal #10. A continuous input on terminal #10 will only raise the arm **one time**. Once this contact is dropped, the sequence will start over again.
- An input on terminal #10 will also enable terminal #11. This input is only active while terminal #10 has a maintained contact present.

Enable UP Input - Terminal #11: This input provides a controllable up command for the Barrier Gate Operator Arm:

- When a contact is present at terminal #10, then terminal #11 will provide normal UP command performance for the Barrier Gate Operator Arm.
- If no input is present on terminal #10, then all commands received at terminal #11 are ignored.

Function of the Dry Relay Contacts - Terminals #12 & #13: These inputs provide a link from the 1601 to the Slide/Swing/Overhead gate for Shadow Loop operation. These inputs are set to operate in conjunction with the Loop Detector plugged into the DOWN Loop Port.

Set the relay jumper on the main circuit board to “Normally Open” (NO).

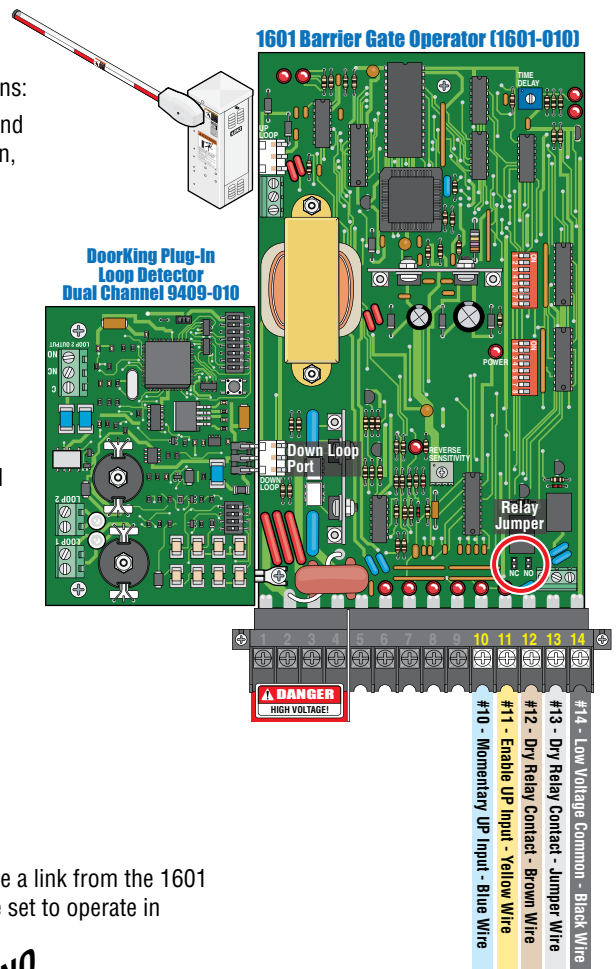
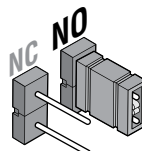

Color code in manual.

6100/6300 Swing Gate Operator

Function of the Dry Relay Contacts - Terminals #16 & #17:

The relay inputs provide two basic functions.

- When the swing gate reaches the full open position, the relay contacts close. This provides a key input to the 1601 Momentary UP (terminal #10), raising the arm and activating the 1601 Enable UP (terminal #11).
- While the relay contacts are closed, they route the common leg of the shadow loop output from the 1601 to the 6100/6300 operator.

Set the relay jumper on the main circuit board to “Normally Open” (NO).

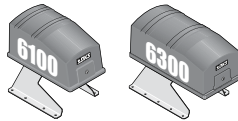
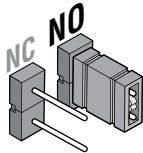

6100/6300 Primary/Single Swing Gate Operator (4502-018)

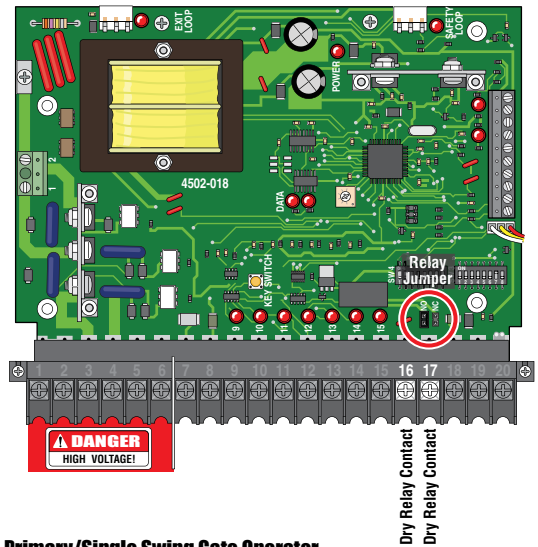

6500 Swing Gate Operator

Function of the Dry Relay Contacts - Terminals #10 & #11:

The relay inputs provide two basic functions.

- When the swing gate reaches the full open position, the relay contacts close. This provides a key input to the 1601 Momentary UP (terminal #10), raising the arm and activating the 1601 Enable UP (terminal #11).
- While the relay contacts are closed, they route the common leg of the shadow loop output from the 1601 to the 6500 operator.

Set the relay jumper on the main circuit board to “Normally Open” (NO).

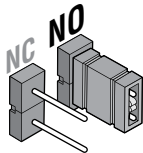

6500 Primary/Single Swing Gate Operator (4405-018)

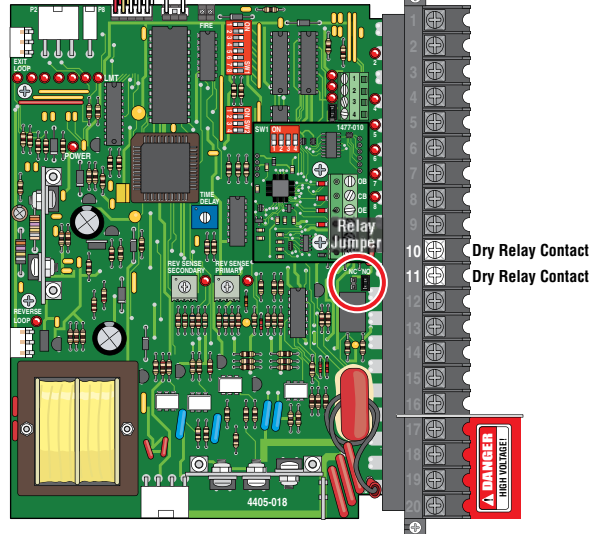

AC Powered 6524 Swing / 9024 Slide Gate Operators

Not for use with the SOLAR Powered 6524 or 9024.

Function of the Dry Relay Contacts - Terminals #13 & #14:

The relay inputs provide two basic functions.

- When the swing/slide gate reaches the full open position, the relay contacts close. This provides a key input to the 1601 Momentary UP (terminal #10), raising the arm and activating the 1601 Enable UP (terminal #11).
- While the relay contacts are closed, they route the common leg of the shadow loop output from the 1601 to the 6524/9024 operator.

Set the relay jumper on the main circuit board to “Normally Open” (NO).

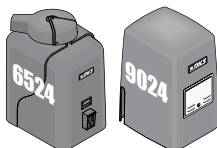
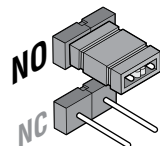

AC Powered ONLY

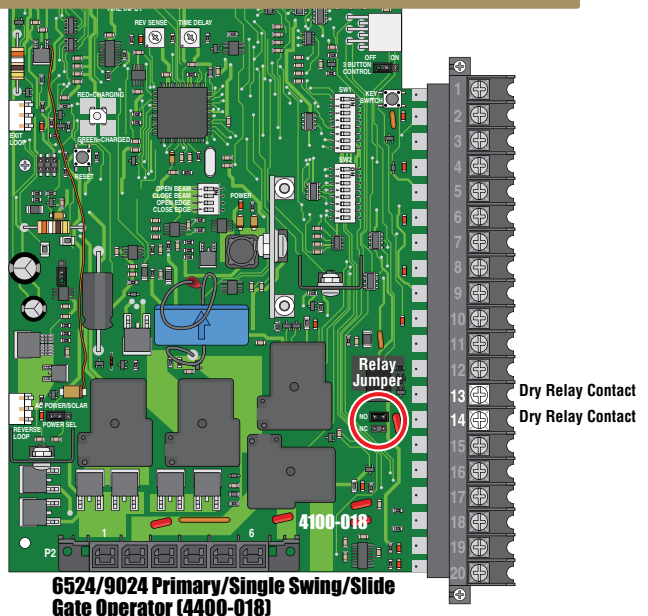

6524/9024 Primary/Single Swing/Slide Gate Operator (4400-018)

9000 Slide Gate Operator

Function of the Dry Relay Contacts - Terminals #10 & #11:

The relay inputs provide two basic functions.

- When the slide gate reaches the full open position, the relay contacts close. This provides a key input to the 1601 Momentary UP (terminal #10), raising the arm and activating the 1601 Enable UP (terminal #11).
- While the relay contacts are closed, they route the common leg of the shadow loop output from the 1601 to the 9000 operator.

Set the relay jumper on the main circuit board to “Normally Open” (NO).

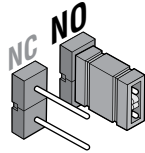

9000 Slide Gate Operator (4405-018)

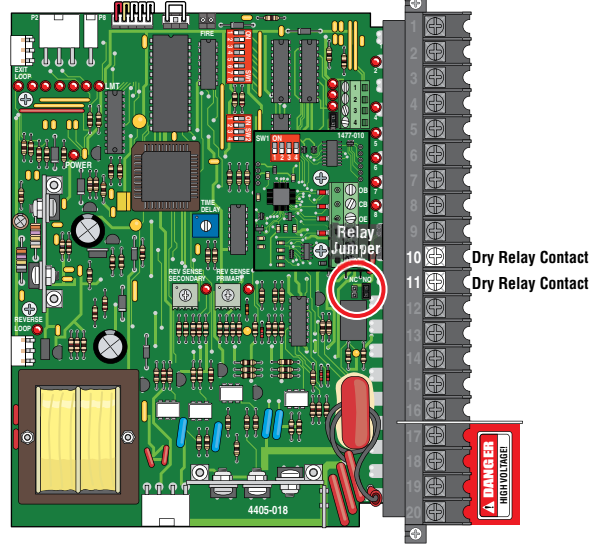

9100/9150 Slide Gate Operator

Function of the Dry Relay Contacts - Terminals #15 & #16:

The relay inputs provide two basic functions.

- When the slide gate reaches the full open position, the relay contacts close. This provides a key input to the 1601 Momentary UP (terminal #10), raising the arm and activating the 1601 Enable UP (terminal #11).
- While the relay contacts are closed, they route the common leg of the shadow loop output from the 1601 to the 9100/9150 operator.

Set the relay jumper on the main circuit board to “Normally Open” (NO).

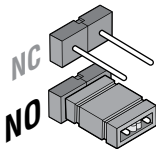

Dry Relay Contact
Dry Relay Contact

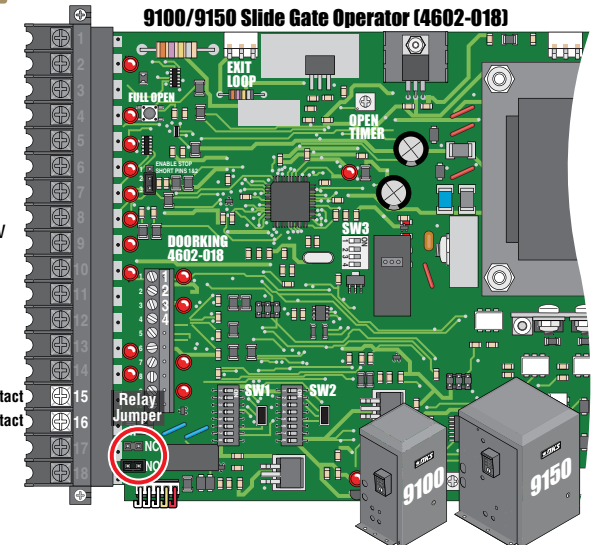

1175 Overhead Gate Operator

Function of the Dry Relay Contacts - Terminals #10 & #11:

The relay inputs provide two basic functions.

- When the overhead gate reaches the full open position, the relay contacts close. This provides a key input to the 1601 Momentary UP (terminal #10), raising the arm and activating the 1601 Enable UP (terminal #11).
- While the relay contacts are closed, they route the common leg of the shadow loop output from the 1601 to the 1175 operator.

Set the relay jumper on the main circuit board to “Normally Open” (NO).

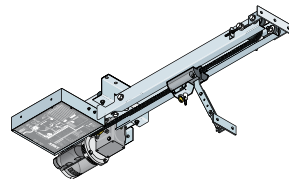
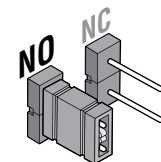

1175 Overhead Gate Operator (4405-018)

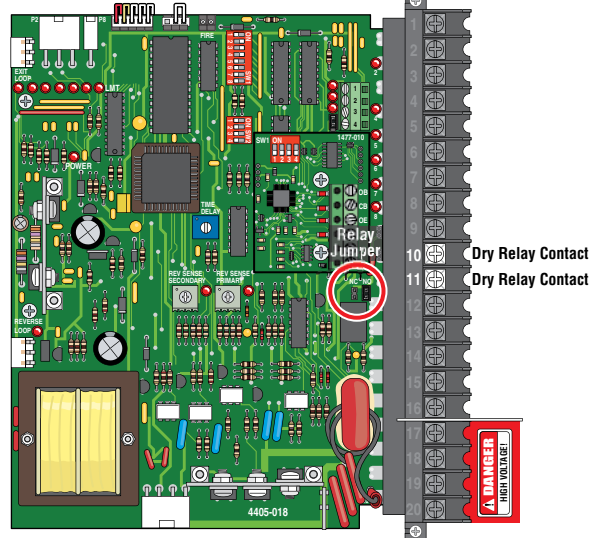

IMPORTANT: If the Barrier Gate Operator Arm is Broken

If the Barrier Gate Arm is broken, there is **NO SAFETY** function in the gate system. Shadow Loops will hold the gate open while a vehicle is present. However, once the gate begins to close, an approaching vehicle **WILL NOT stop or reverse the gates. DoorKing's First Recommendation is to Open Both Gates and Shut Down the System until the arm can be replaced.**

If the customer demands that the main gates remain in operation with the arm broken, **Do Not Turn OFF the power to the 1601.** All the system loops are routed through the 1601. Turning off power will deactivate **All** the system loops, allowing the main gates to close on a vehicle if it is in the gate's pathway after they have timed out. Lock the toggle switch inside the 1601 into the "UP" position. This will allow all system loops to function until the arm can be replaced.

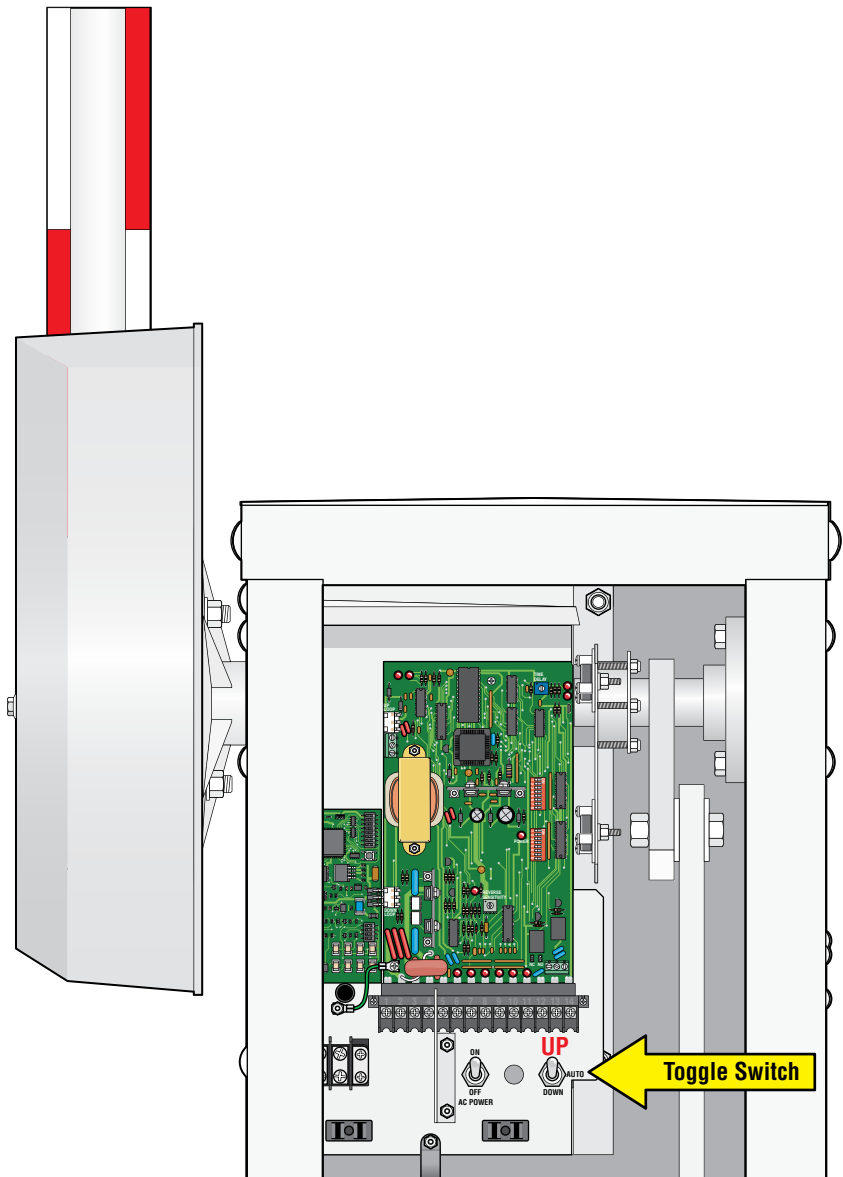

SECTION 4 - OPERATOR WIRING AND SETTINGS GUIDELINES

DoorKing Swing/Slide/Overhead Gate Operators are wired to the Barrier Gate Operator in a specific way for each operator type. Follow the operator wiring, DIP-switch and relay settings for your chosen setup on the next pages.

All wires should be run in underground conduit and low voltage wire insulation should be run in separate conduits from high voltage wire insulation. **NEVER** run them in the same conduit.

Each operator needs the correct AC power wire gauge and wire insulation for the specific wire run distance away from the main power source (See the specific Installation/Owner's manual for "High voltage wire size and distance table" for your chosen operator). Too low of voltage caused by too small of wires, to any operator in the system may cause a system malfunction.

Use heavy enough gauge wire with the proper wire insulation to connect the operators together. DoorKing recommends 18 AWG minimum. Using a lighter gauge wire may cause communication problems between the operators. Make sure all wiring stays clear of the moving parts inside the operators.

All the operators and access control devices **MUST** be properly grounded! The system will NOT function properly if this is not done.

6100/6300 Swing Gate(s) - Entry Lanes Wiring

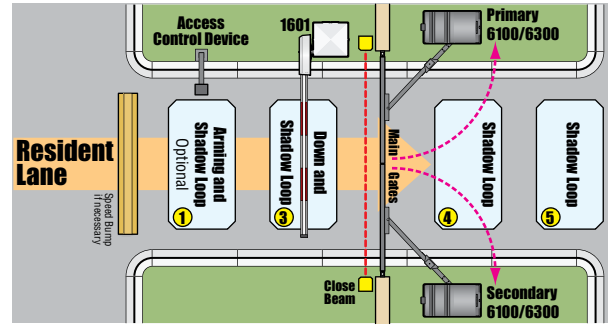
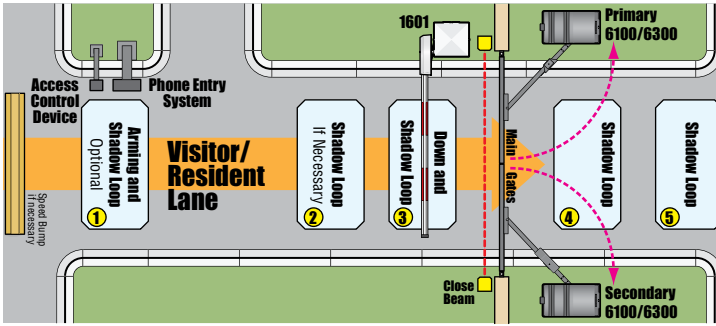

6100/6300 Primary/Single Swing Gate Operator (4502-018)

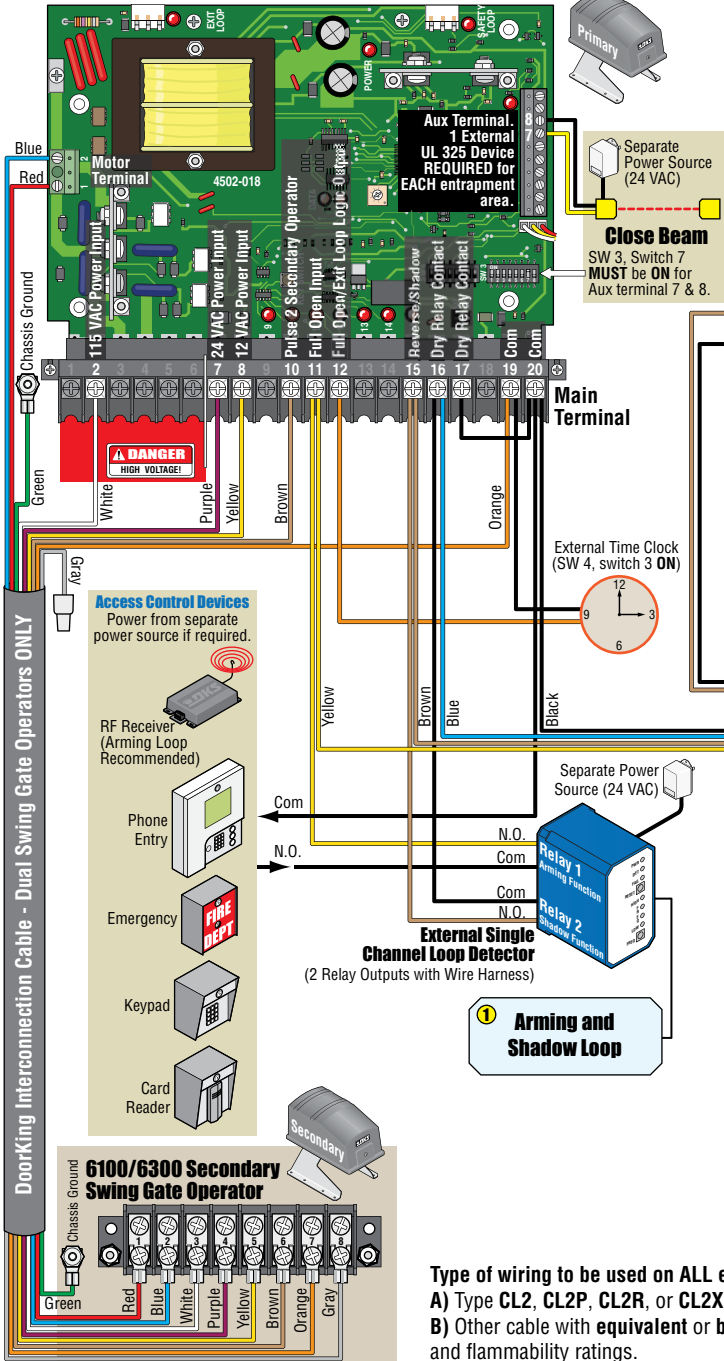

1601 Barrier Gate Operator (1601-010)

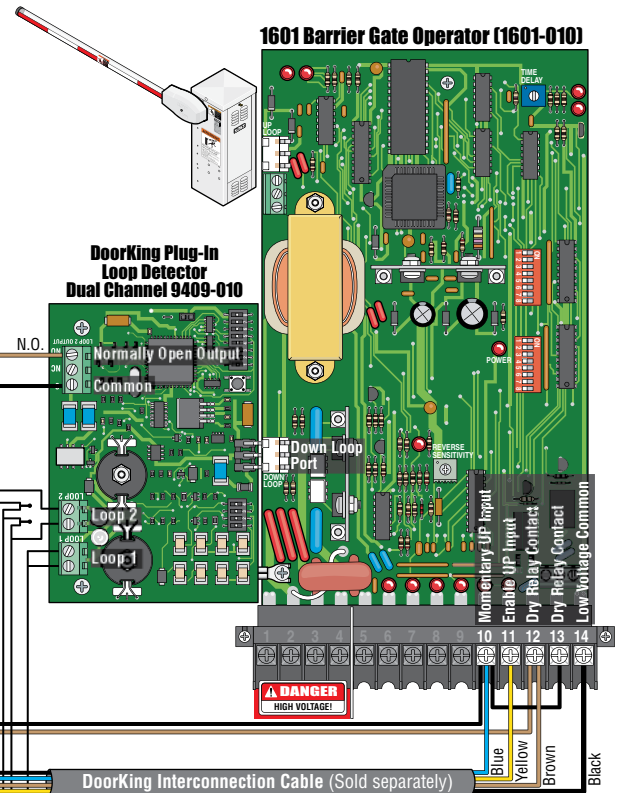

Gate Operator's Critical Settings:

1601 Barrier Gate Operator: Set Down/Reverse loop to function as Down Loop (SW 1, switch 4 ON). Set the Up input function (SW 1, switch 6 OFF). Auto-Close Timer (SW 1, switch 7 ON). Set timer at around 5-10 seconds based upon the system layout. 1601 MUST always time out and close **BEFORE** the 6100/6300. Set 1601 Dry Contact Relay to function with Down Loop detector (SW 1, switch 5 OFF). Set relay to Normally Open (NO). Works only with DoorKing Plug-In Loop Detectors.

6100/6300 Swing Gate Operator: Auto-Close Timer (SW 4, switch 4 ON). Set timer long enough that the 1601 will lower arm **BEFORE** the 6100/6300 starts to close in **ALL** situations. Set Swing/Slide gate type for Swing Gate (SW 4, switch 5 ON). Set Reverse/Shadow input (SW 3, switch 5 OFF) for REVERSE function, **DO NOT** set for Shadow function. Set 6100/6300 Dry Contact Relay to activate when gate is in Full Open Position (SW 4, switches 1 & 2 OFF). Set relay to Normally Open (NO).



- 3 Down and Shadow Loop
- Shadow Loops Wired in Series
- 2 Shadow Loop If Necessary
- 4 Shadow Loop
- 5 Shadow Loop

Type of wiring to be used on ALL external devices:
A) Type CL2, CL2P, CL2R, or CL2X.
B) Other cable with equivalent or better electrical, mechanical, and flammability ratings.

6100/6300 Swing Gate(s) - Exit Lane Wiring

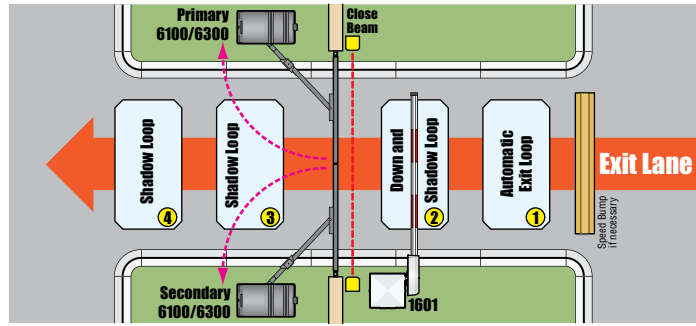

6100/6300 Primary/Single Swing Gate Operator (4502-018)

1601 Barrier Gate Operator (1601-010)

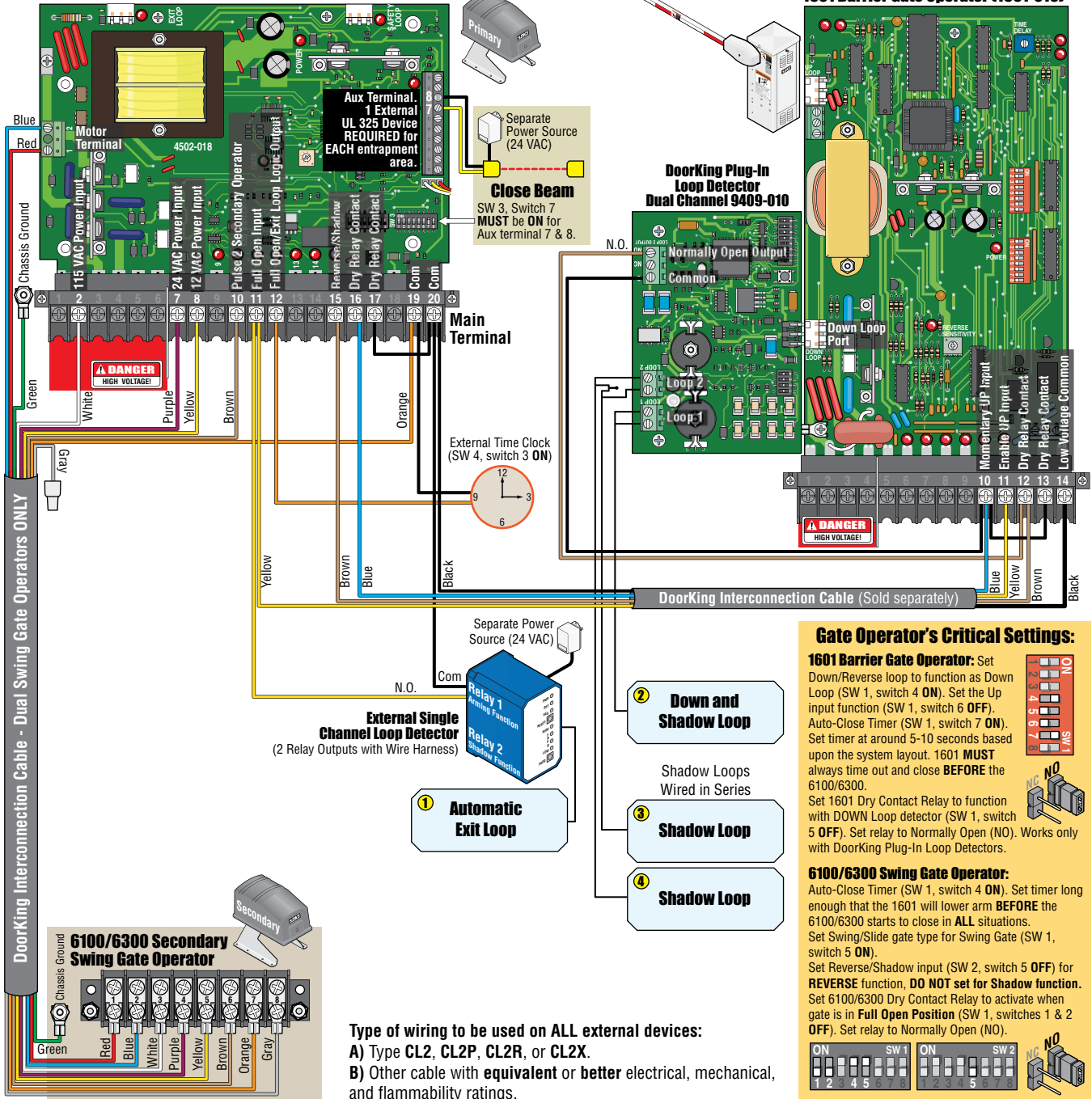

Type of wiring to be used on ALL external devices:
A) Type CL2, CL2P, CL2R, or CL2X.
B) Other cable with equivalent or better electrical, mechanical, and flammability ratings.

6500 Swing Gate(s) - Entry Lanes Wiring

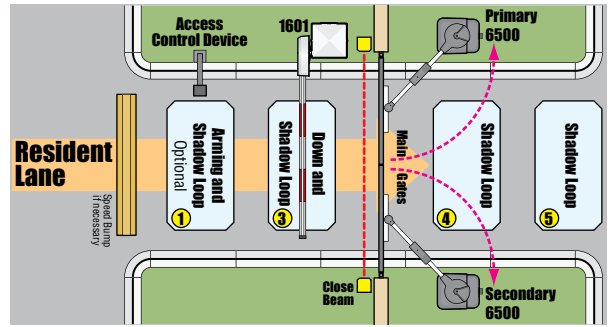
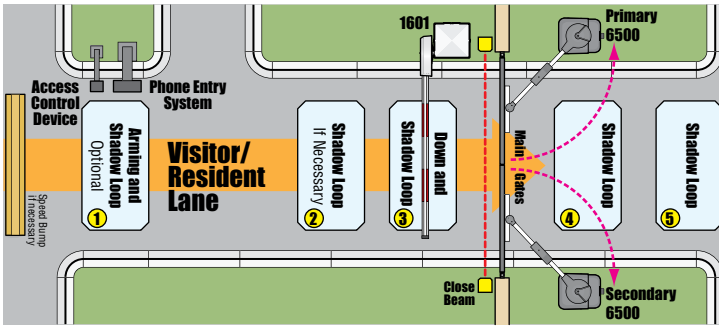

6500 Primary/Single Swing Gate Operator (4405-018)

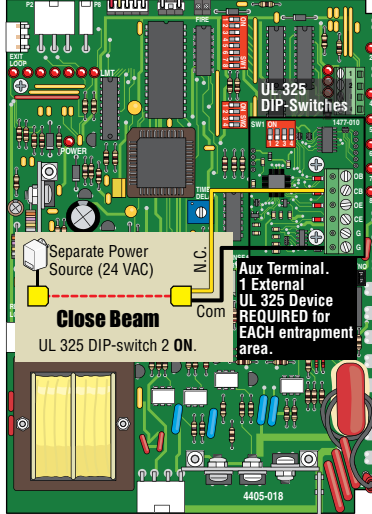

1601 Barrier Gate Operator (1601-010)

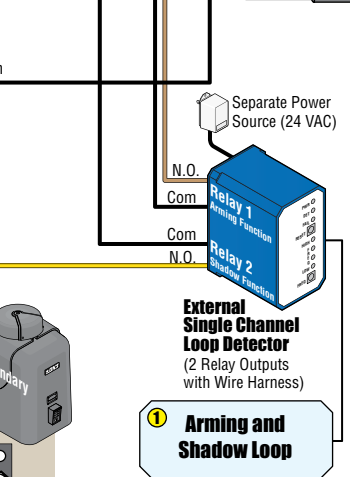
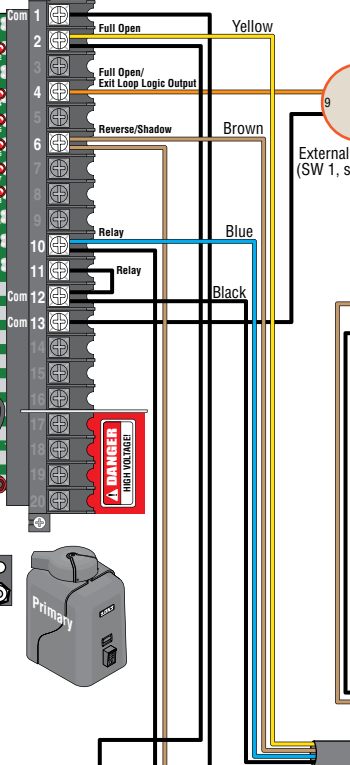
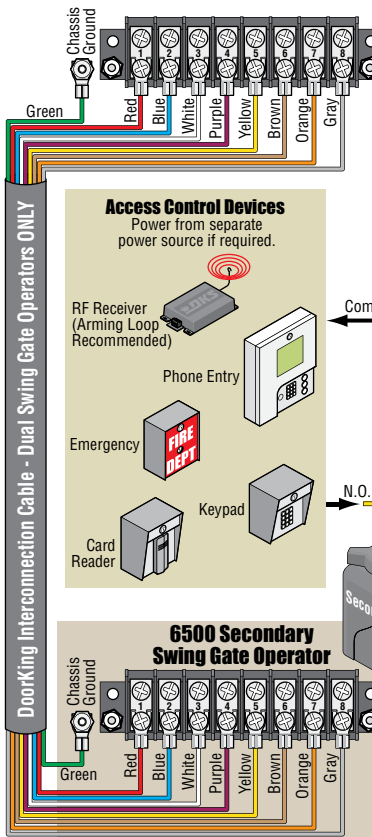
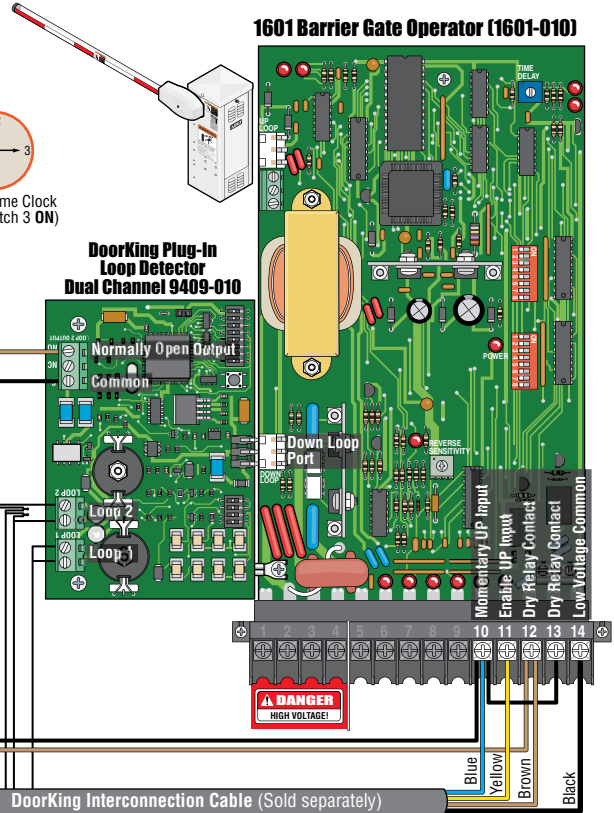

- 3 Down and Shadow Loop
- Shadow Loops Wired in Series
- 2 Shadow Loop If Necessary
- 4 Shadow Loop
- 5 Shadow Loop

Gate Operator's Critical Settings:

1601 Barrier Gate Operator: Set Down/Reverse loop to function as Down Loop (SW 1, switch 4 ON). Set the Up input function (SW 1, switch 6 OFF). Auto-Close Timer (SW 1, switch 7 ON). Set timer at around 5-10 seconds based upon the system layout. 1601 **MUST** always time out and close **BEFORE** the 6500.

Set 1601 Dry Contact Relay to function with DOWN Loop detector (SW 1, switch 5 OFF). Set relay to Normally Open (NO). Works only with DoorKing Plug-In Loop Detectors.

6500 Swing Gate Operator: Auto-Close Timer (SW 1, switch 4 ON). Set timer long enough that the 1601 will lower arm **BEFORE** the 6500 starts to close in **ALL** situations. Set Reverse/Shadow input (SW 1, switch 5 OFF) for **REVERSE** function, **DO NOT** set for Shadow function. Set 6500 Dry Contact Relay to activate when gate is in **Full Open Position** (SW 1, switches 7 & 8 OFF). Set relay to Normally Open (NO).

6500 Swing Gate(s) - Exit Lane Wiring

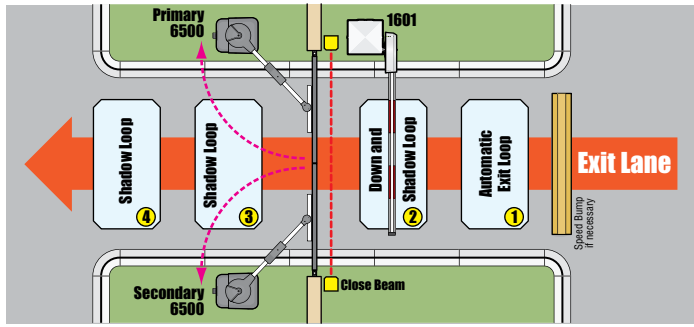

6500 Primary/Single Swing Gate Operator (4405-018)

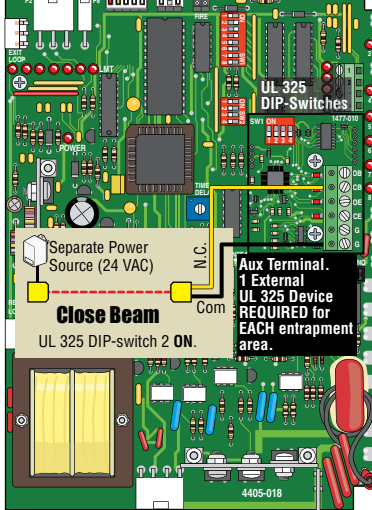

1601 Barrier Gate Operator (1601-010)

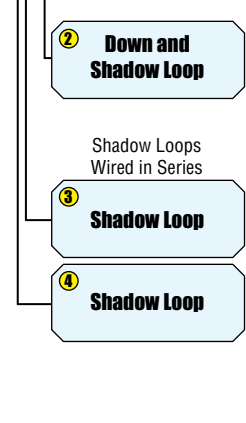
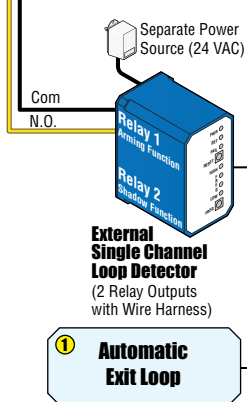
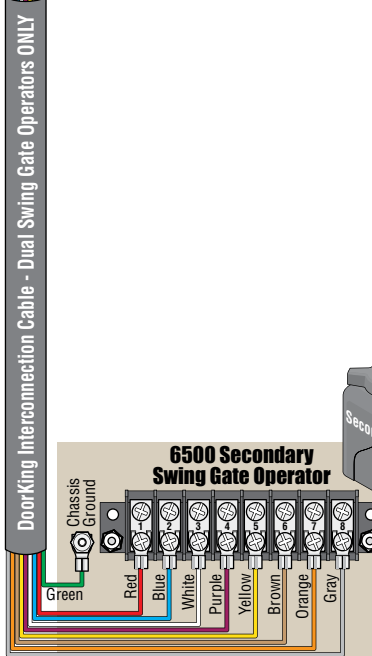
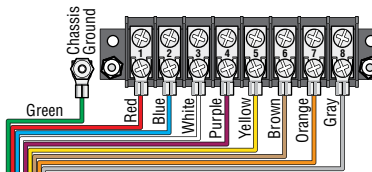
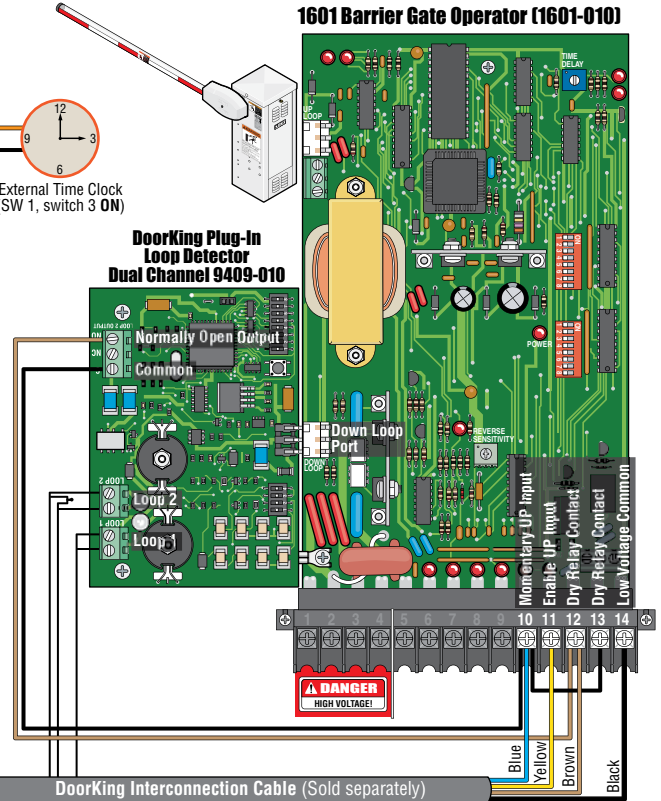

Gate Operator's Critical Settings:

1601 Barrier Gate Operator: Set Down/Reverse loop to function as Down Loop (SW 1, switch 4 ON). Set the Up input function (SW 1, switch 6 OFF). Auto-Close Timer (SW 1, switch 7 ON). Set timer at around 5-10 seconds based upon the system layout. 1601 **MUST** always time out and close **BEFORE** the 6500.

Set 1601 Dry Contact Relay to function with DOWN Loop detector (SW 1, switch 5 OFF). Set relay to Normally Open (NO). Works only with DoorKing Plug-In Loop Detectors.

6500 Swing Gate Operator: Auto-Close Timer (SW 1, switch 4 ON). Set timer long enough that the 1601 will lower arm **BEFORE** the 6500 starts to close in **ALL** situations. Set Reverse/Shadow input (SW 1, switch 5 OFF) for **REVERSE** function. **DO NOT** set for Shadow function. Set 6500 Dry Contact Relay to activate when gate is in **Full Open Position** (SW 1, switches 7 & 8 OFF). Set relay to Normally Open (NO).

Type of wiring to be used on ALL external devices:

A) Type CL2, CL2P, CL2R, or CL2X.

B) Other cable with equivalent or better electrical, mechanical, and flammability ratings.

6524 Swing Gate(s) - Entry Lanes Wiring

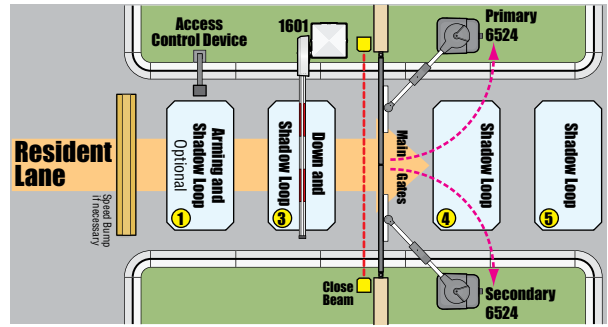
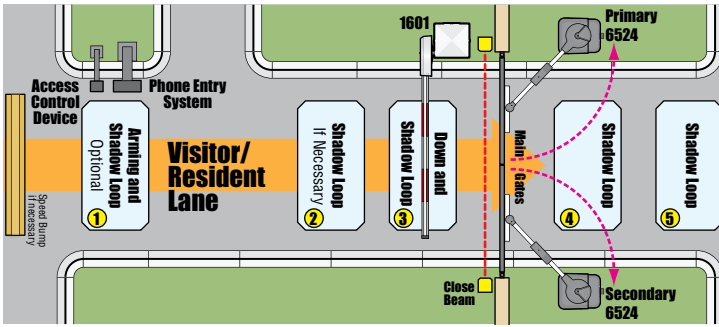

6524 Primary/Single Swing Gate Operator (4100-018)

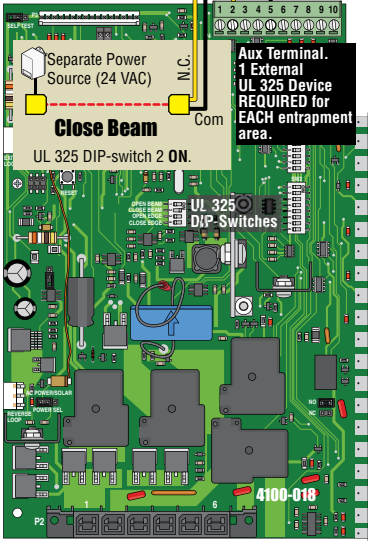

Primary operator is determined by pressing its **KEY SWITCH FIRST** after powering up operators. This establishes Primary/Secondary operator order when using Bi-parting gates.

AC Powered 6524.

1601 Barrier Gate Operator (1601-010)

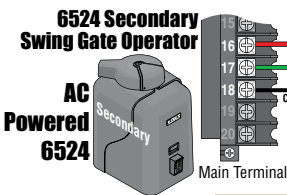
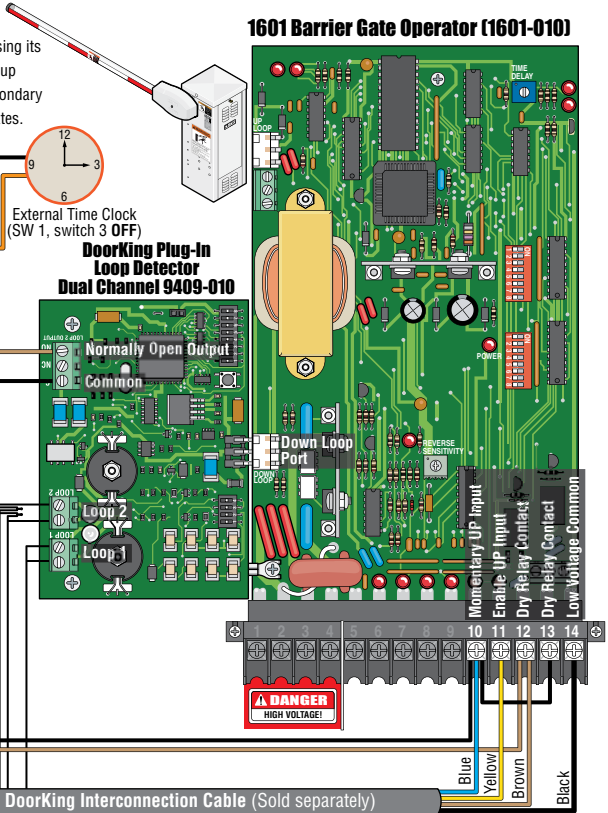

Access Control Devices

Power from separate power source if required.

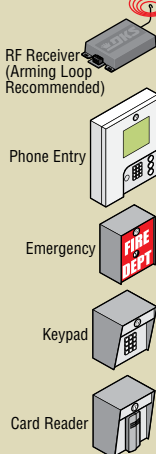

Type of wiring to be used on ALL external devices:
A) Type CL2, CL2P, CL2R, or CL2X.
B) Other cable with equivalent or better electrical, mechanical, and flammability ratings.

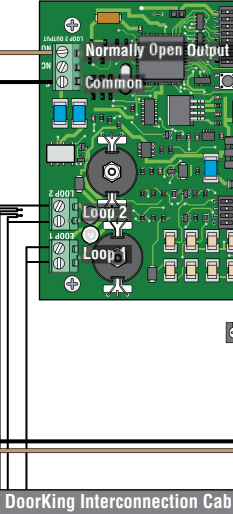
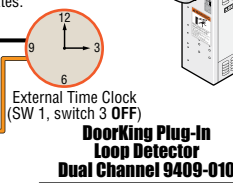
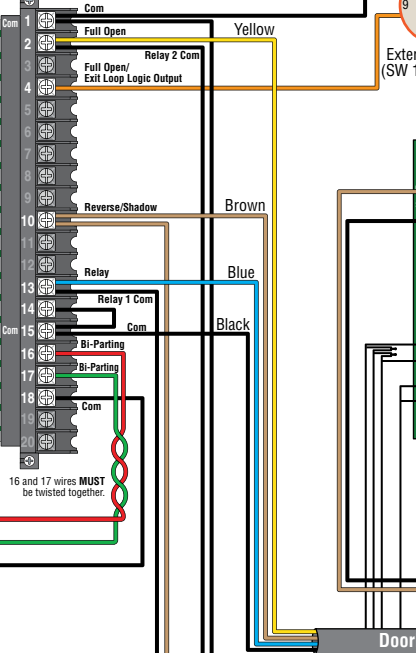

Gate Operator's Critical Settings:

1601 Barrier Gate Operator: Set Down/Reverse loop to function as Down Loop (SW 1, switch 4 ON). Set the Up input function (SW 1, switch 6 OFF). Auto-Close Timer (SW 1, switch 7 ON). Set timer at around 5-10 seconds based upon the system layout. 1601 **MUST** always time out and close **BEFORE** the 6500.

Set 1601 Dry Contact Relay to function with DOWN Loop detector (SW 1, switch 5 OFF). Set relay to Normally Open (NO). Works only with DoorKing Plug-In Loop Detectors.

6524 Swing Gate Operator:

Auto-Close Timer (SW 1, switch 2 ON). Set timer long enough that the 1601 will lower arm **BEFORE** the 6524 starts to close in **ALL** situations. Set Reverse/Shadow input (SW 2, switch 4 OFF) for **REVERSE** function, **DO NOT** set for Shadow function. Set 6524 Dry Contact Relay to activate when gate is in **Full Open Position** (SW 1, switches 6 & 7 OFF). Set relay to Normally Open (NO).

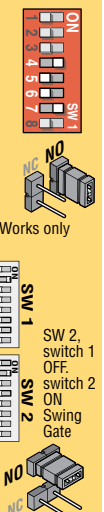

- 3 Down and Shadow Loop
- Shadow Loops Wired in Series
- 2 Shadow Loop If Necessary
- 4 Shadow Loop
- 5 Shadow Loop

Not for use with the SOLAR Powered 6524.

6524 Swing Gate(s) - Exit Lane Wiring

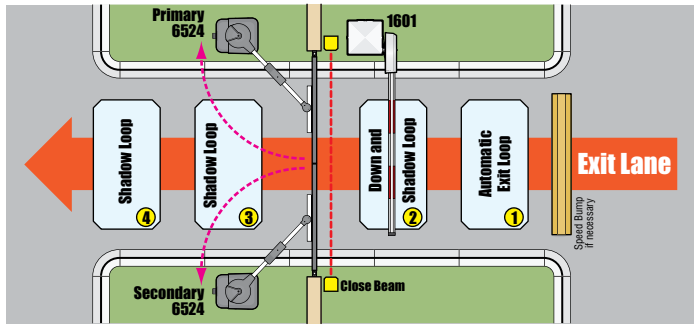

6524 Primary/Single Swing Gate Operator (4100-018)

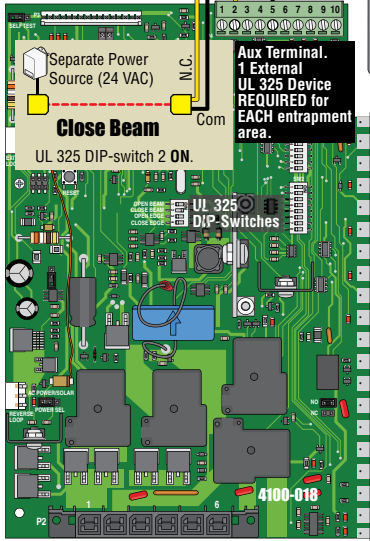

Primary operator is determined by pressing its **KEY SWITCH FIRST** after powering up operators. This establishes Primary/Secondary operator order when using Bi-parting gates.

AC Powered 6524.

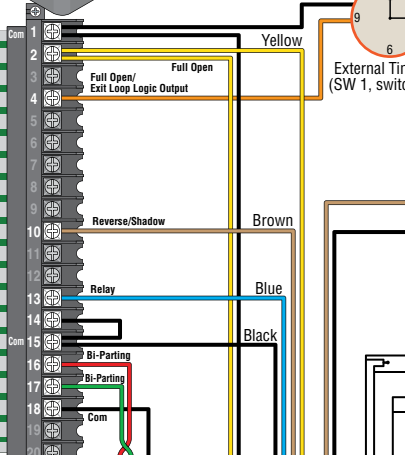

1601 Barrier Gate Operator (1601-010)

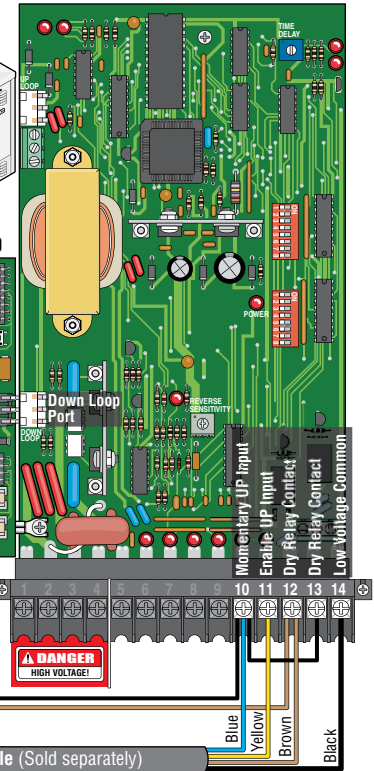

6524 Secondary Swing Gate Operator

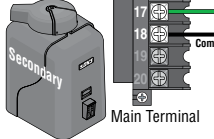

AC Powered 6524.

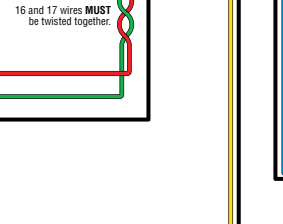

External Single Channel Loop Detector

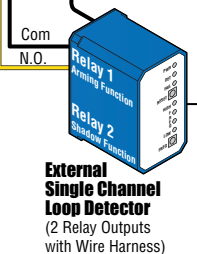

Automatic Exit Loop

- 2 Down and Shadow Loop
- Shadow Loops Wired in Series
- 3 Shadow Loop
- 4 Shadow Loop

Gate Operator's Critical Settings:

1601 Barrier Gate Operator: Set Down/Reverse loop to function as Down Loop (SW 1, switch 4 ON). Set the Up input function (SW 1, switch 6 OFF). Auto-Close Timer (SW 1, switch 7 ON). Set timer at around 5-10 seconds based upon the system layout. 1601 **MUST** always time out and close **BEFORE** the 6500. Set 1601 Dry Contact Relay to function with DOWN Loop detector (SW 1, switch 5 OFF). Set relay to Normally Open (NO). Works only with DoorKing Plug-In Loop Detectors.

6524 Swing Gate Operator: Auto-Close Timer (SW 1, switch 2 ON). Set timer long enough that the 1601 will lower arm **BEFORE** the 6524 starts to close in **ALL** situations. Set Reverse/Shadow input (SW 2, switch 4 OFF) for **REVERSE** function, **DO NOT** set for Shadow function. Set 6524 Dry Contact Relay to activate when gate is in **Full Open Position** (SW 1, switches 6 & 7 OFF). Set relay to Normally Open (NO).

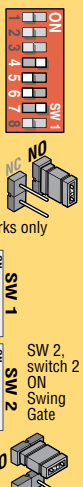

Not for use with the SOLAR Powered 6524.

Type of wiring to be used on ALL external devices:
A) Type CL2, CL2P, CL2R, or CL2X.
B) Other cable with equivalent or better electrical, mechanical, and flammability ratings.

9000 Slide Gate - Entry Lane Wiring

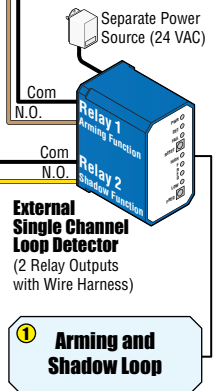
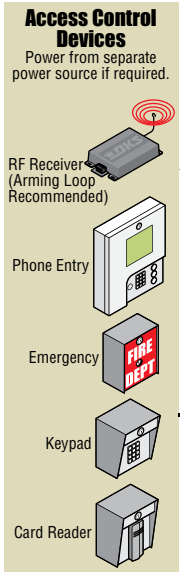
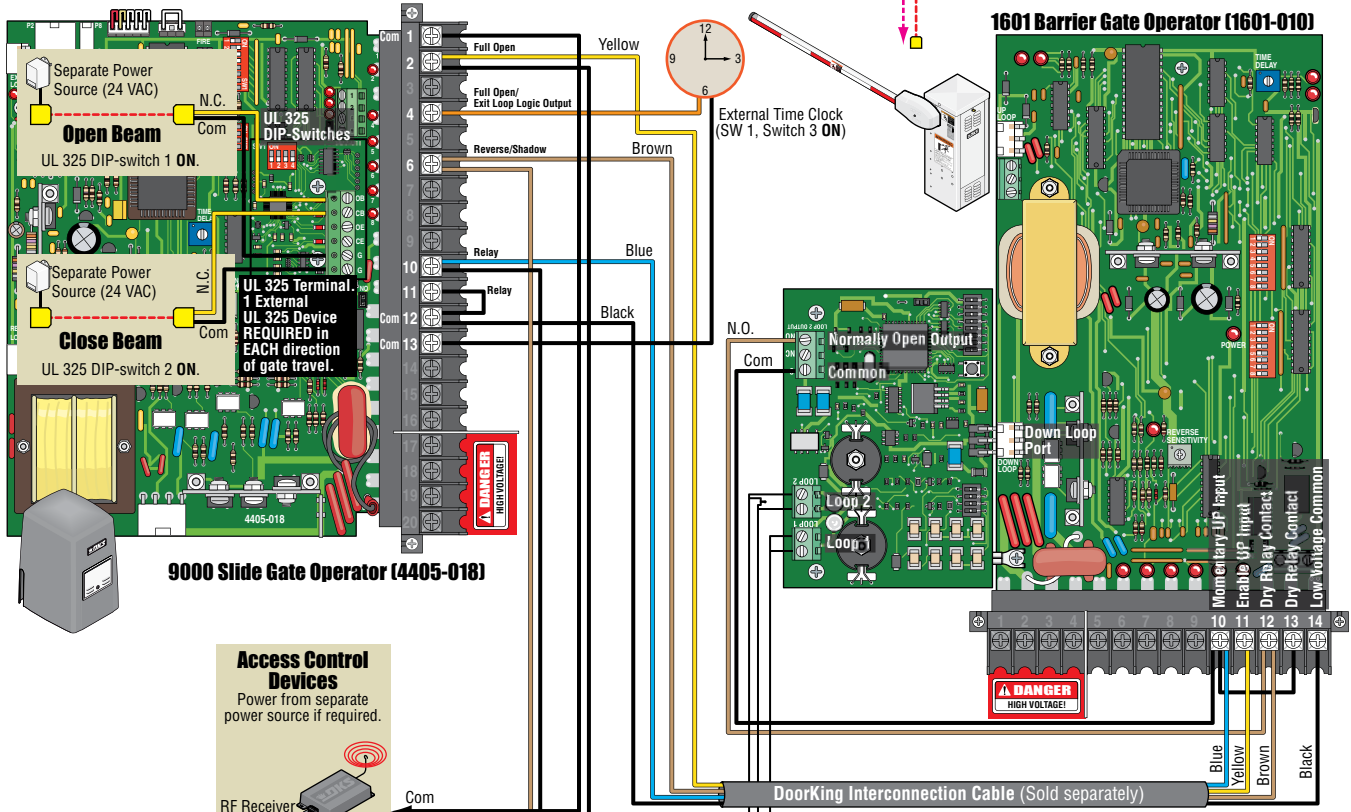
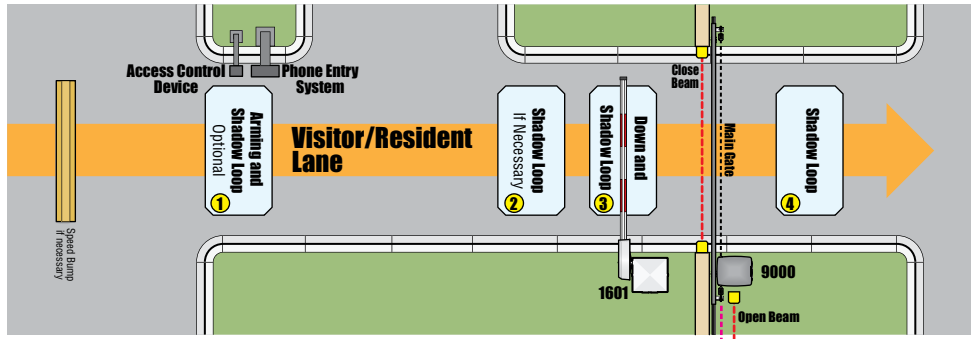

- ③ Down and Shadow Loop
- Shadow Loops Wired in Series
- ② Shadow Loop If Necessary
- ④ Shadow Loop
- ① Arming and Shadow Loop

Gate Operator's Critical Settings:

1601 Barrier Gate Operator: Set Down/Reverse loop to function as Down Loop (SW 1, switch 4 ON). Set the Up input function (SW 1, switch 6 OFF). Auto-Close Timer (SW 1, switch 7 ON). Set timer at around 5-10 seconds based upon the system layout. 1601 MUST always time out and close BEFORE the 9000. Set 1601 Dry Contact Relay to function with DOWN Loop detector (SW 1, switch 5 OFF). Set relay to Normally Open (NO). Works only with DoorKing Plug-In Loop Detectors.

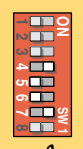

9000 Slide Gate Operator: Auto-Close Timer (SW 1, switch 4 ON). Set timer long enough that the 1601 will lower arm BEFORE the 9000 starts to close in ALL situations. Set Reverse/Shadow input (SW 1, switch 5 OFF) for REVERSE function, DO NOT set for Shadow function. Set 9000 Dry Contact Relay to activate when gate is in Full Open Position (SW 1, switches 7 & 8 OFF). Set relay to Normally Open (NO).

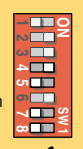

Type of wiring to be used on ALL external devices:
A) Type CL2, CL2P, CL2R, or CL2X.
B) Other cable with equivalent or better electrical, mechanical, and flammability ratings.

9000 Slide Gate - Exit Lane Wiring

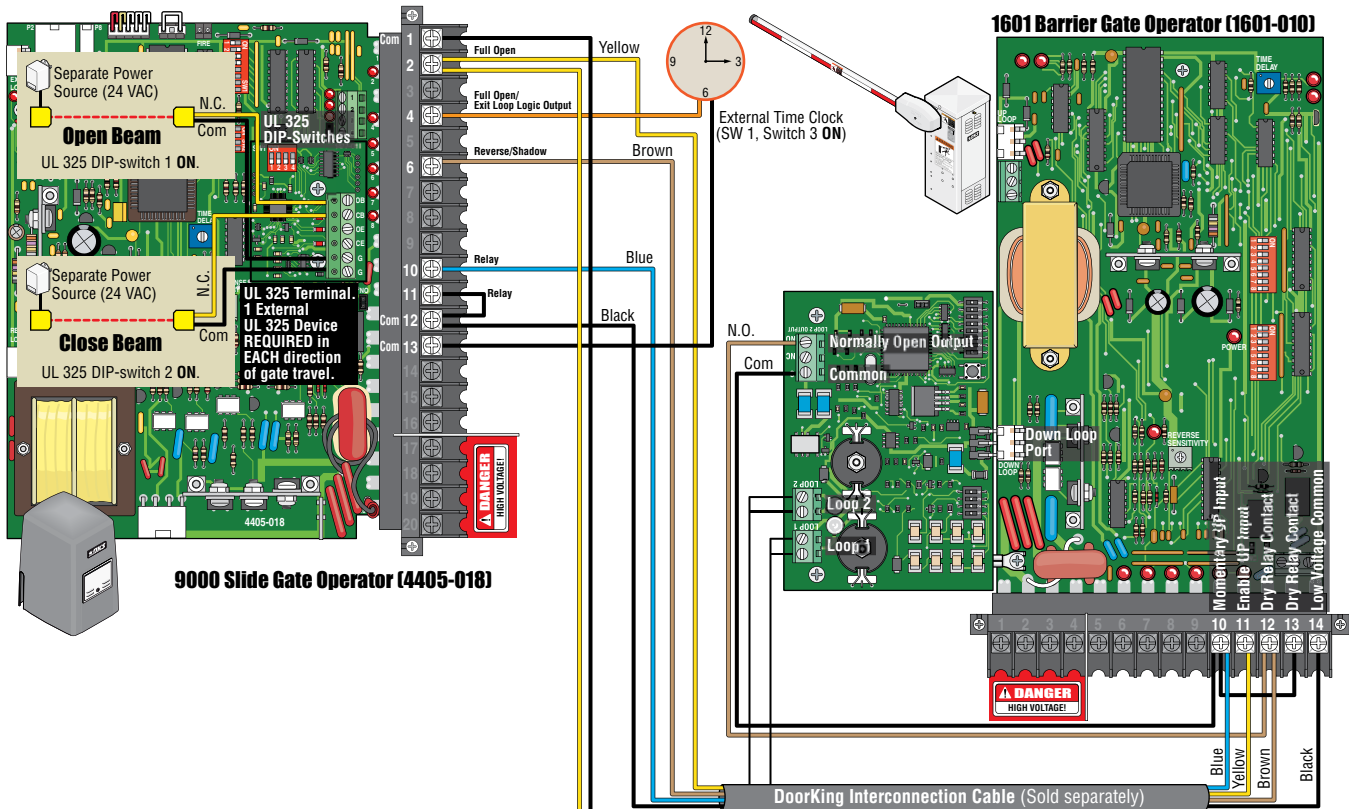
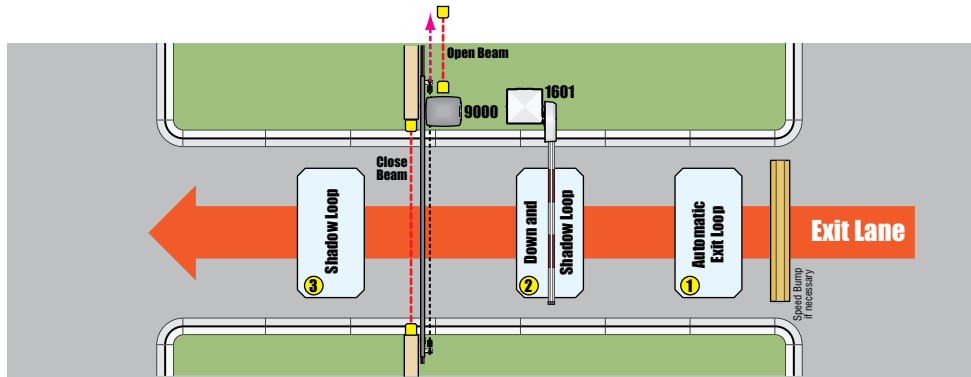

Gate Operator's Critical Settings:

1601 Barrier Gate Operator: Set Down/Reverse loop to function as Down Loop (SW 1, switch 4 ON). Set the Up input function (SW 1, switch 6 OFF). Auto-Close Timer (SW 1, switch 7 ON). Set timer at around 5-10 seconds based upon the system layout. 1601 **MUST** always time out and close **BEFORE** the 9000. Set 1601 Dry Contact Relay to function with DOWN Loop detector (SW 1, switch 5 OFF). Set relay to Normally Open (NO). Works only with DoorKing Plug-In Loop Detectors.

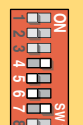

9000 Slide Gate Operator: Auto-Close Timer (SW 1, switch 4 ON). Set timer long enough that the 1601 will lower arm **BEFORE** the 9000 starts to close in **ALL** situations. Set Reverse/Shadow input (SW 1, switch 5 OFF) for **REVERSE** function, **DO NOT** set for Shadow function. Set 9000 Dry Contact Relay to activate when gate is in **Full Open Position** (SW 1, switches 7 & 8 OFF). Set relay to Normally Open (NO).



Type of wiring to be used on ALL external devices:
A) Type CL2, CL2P, CL2R, or CL2X.
B) Other cable with equivalent or better electrical, mechanical, and flammability ratings.

9024 Slide Gate - Entry Lane Wiring

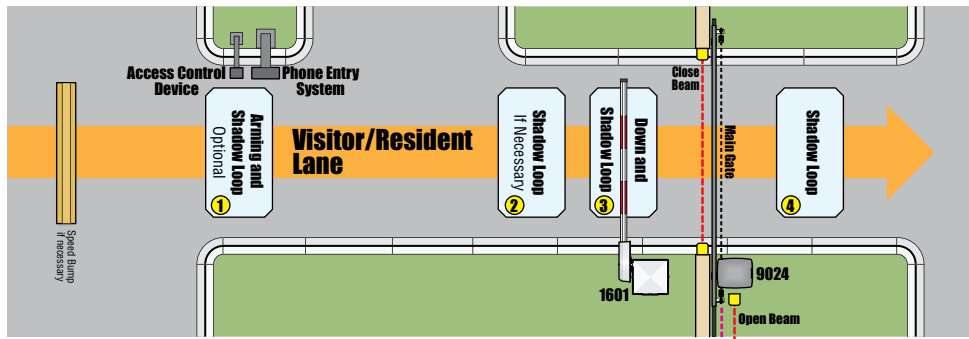

9024 Slide Gate Operator (4100-018)

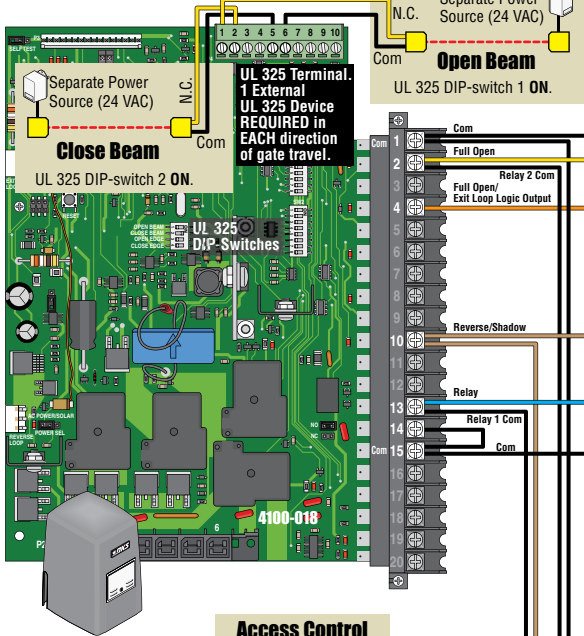

1601 Barrier Gate Operator (1601-010)

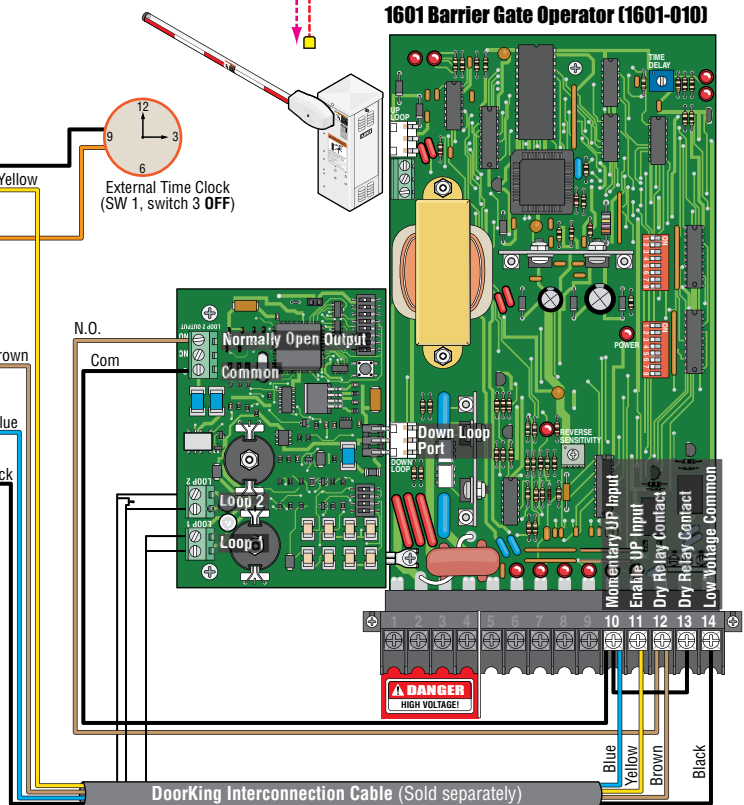

AC Powered 9024.

Access Control Devices

Power from separate power source if required.

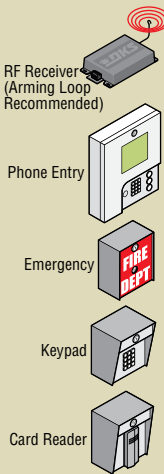

1 Arming and Shadow Loop

3 Down and Shadow Loop

2 Shadow Loop If Necessary

4 Shadow Loop

Type of wiring to be used on ALL external devices:

- A) Type CL2, CL2P, CL2R, or CL2X.
- B) Other cable with equivalent or better electrical, mechanical, and flammability ratings.

Gate Operator's Critical Settings:

1601 Barrier Gate Operator: Set Down/Reverse loop to function as Down Loop (SW 1, switch 4 ON). Set the Up input function (SW 1, switch 6 OFF). Auto-Close Timer (SW 1, switch 7 ON). Set timer at around 5-10 seconds based upon the system layout. 1601 MUST always time out and close BEFORE the 9000.

Set 1601 Dry Contact Relay to function with DOWN Loop detector (SW 1, switch 5 OFF). Set relay to Normally Open (NO). Works only with DoorKing Plug-In Loop Detectors.

9024 Slide Gate Operator: Auto-Close Timer (SW 1, switch 2 ON). Set timer long enough that the 1601 will lower arm BEFORE the 9024 starts to close in ALL situations. Set Reverse/Shadow input (SW 2, switch 4 OFF) for REVERSE function. DO NOT set for Shadow function. Set 9024 Dry Contact Relay to activate when gate is in Full Open Position (SW 1, switches 6 & 7 OFF). Set relay to Normally Open (NO).

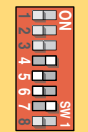

9024 Slide Gate - Exit Lane Wiring

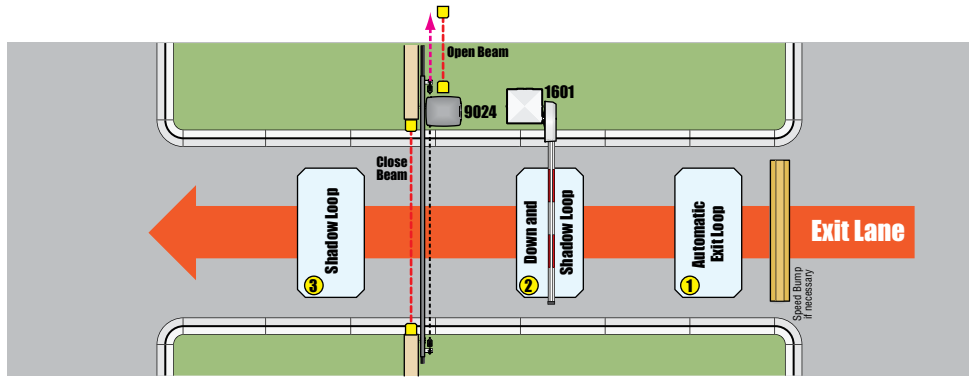

9024 Slide Gate Operator (4100-018)

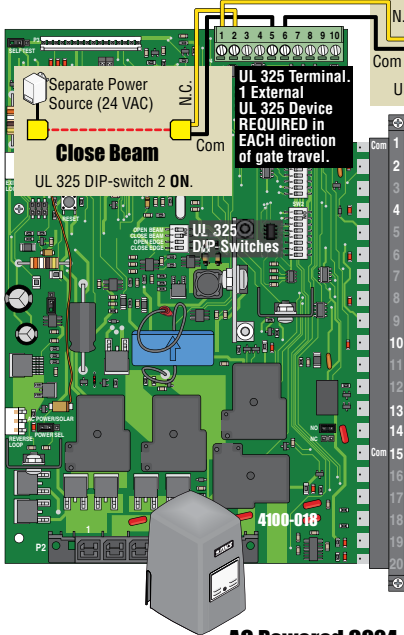

AC Powered 9024.

Not for use with the SOLAR Powered 9024.

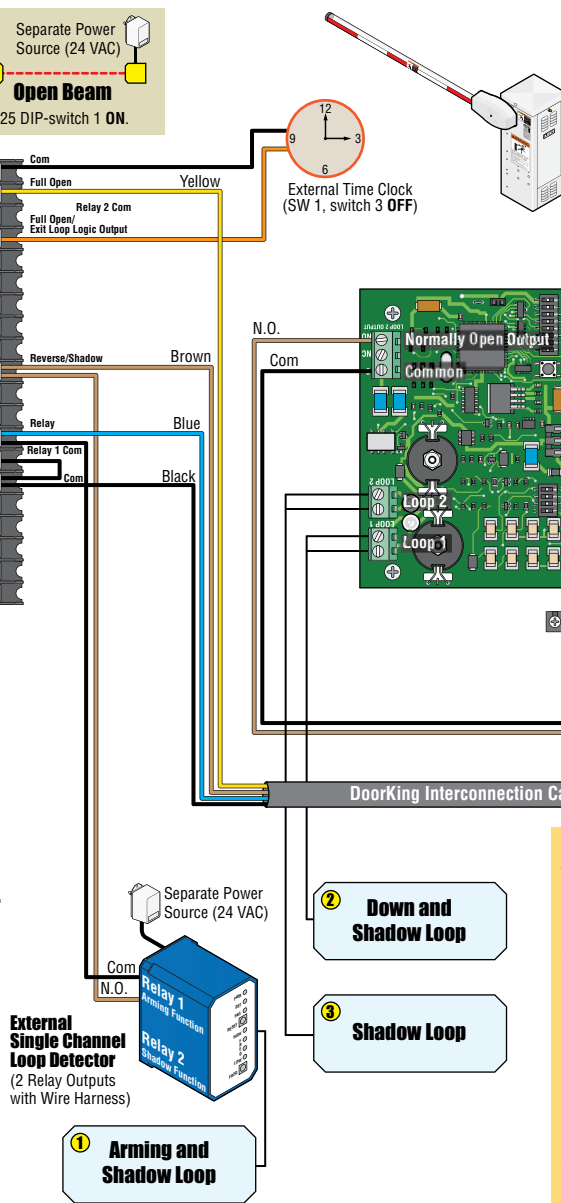

1601 Barrier Gate Operator (1601-010)

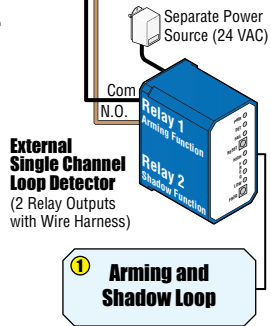

Type of wiring to be used on ALL external devices:
A) Type CL2, CL2P, CL2R, or CL2X.
B) Other cable with equivalent or better electrical, mechanical, and flammability ratings.

Gate Operator's Critical Settings:

1601 Barrier Gate Operator: Set Down/Reverse loop to function as Down Loop (SW 1, switch 4 ON). Set the Up input function (SW 1, switch 6 OFF). Auto-Close Timer (SW 1, switch 7 ON). Set timer at around 5-10 seconds based upon the system layout. 1601 **MUST** always time out and close **BEFORE** the 9000. Set 1601 Dry Contact Relay to function with DOWN Loop detector (SW 1, switch 5 OFF). Set relay to Normally Open (NO). Works only with DoorKing Plug-In Loop Detectors.

9024 Slide Gate Operator: Auto-Close Timer (SW 1, switch 2 ON). Set timer long enough that the 1601 will lower arm **BEFORE** the 9024 starts to close in **ALL** situations. Set Reverse/Shadow input (SW 2, switch 4 OFF) for **REVERSE** function, **DO NOT** set for Shadow function. Set 9024 Dry Contact Relay to activate when gate is in **Full Open Position** (SW 1, switches 6 & 7 OFF). Set relay to Normally Open (NO).

9100/9150 Slide Gate - Entry Lane Wiring

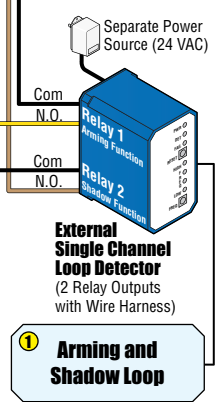
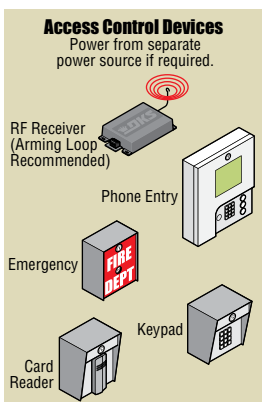
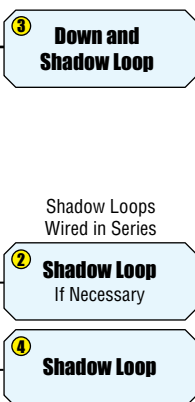
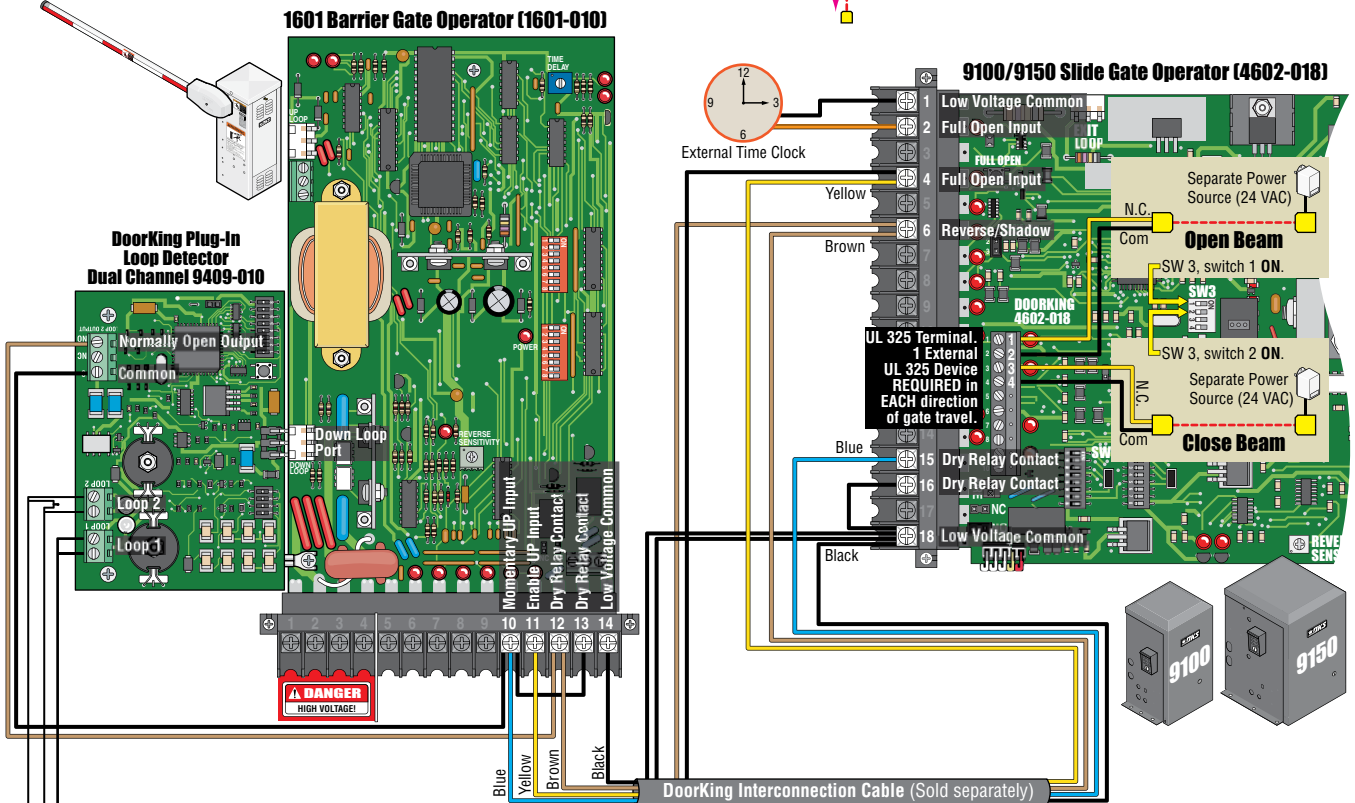
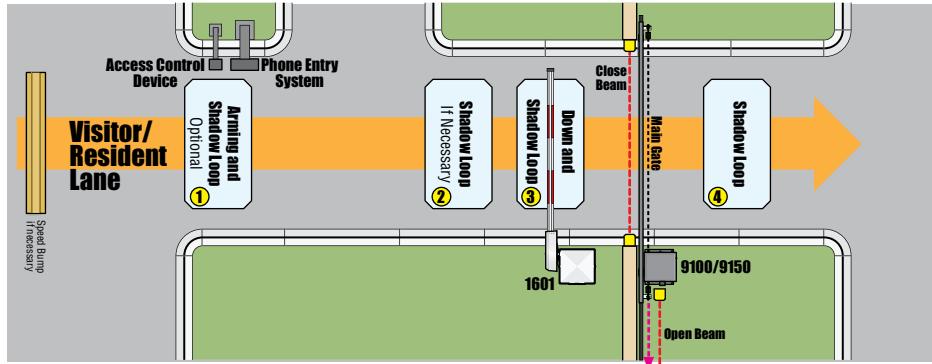

Gate Operator's Critical Settings:

1601 Barrier Gate Operator: Set Down/Reverse loop to function as Down Loop (SW 1, switch 4 ON). Set the Up input function (SW 1, switch 6 OFF). Auto-Close Timer (SW 1, switch 7 ON). Set timer at around 5-10 seconds based upon the system layout. 1601 **MUST** always time out and close **BEFORE** the 9100/9150. Set 1601 Dry Contact Relay to function with DOWN Loop detector (SW 1, switch 5 OFF). Set relay to Normally Open (NO). Works only with DoorKing Plug-In Loop Detectors.

9100/9150 Swing Gate Operator: Auto-Close Timer (SW 1, switch 2 ON). Set timer long enough that the 1601 will lower arm **BEFORE** the 9100/9150 starts to close in **ALL** situations. Set Reverse/Shadow input (SW 2, switch 2 OFF) for **REVERSE** function, **DO NOT** set for Shadow function. Set Swing/Slide gate type for Swing Gate (SW 2, switch 5 OFF). Set 9100/9150 Dry Contact Relay to activate when gate is in **Full Open Position** (SW 1, switches 4 & 5 OFF). Set relay to Normally Open (NO).

Type of wiring to be used on ALL external devices:
A) Type CL2, CL2P, CL2R, or CL2X.
B) Other cable with equivalent or better electrical, mechanical, and flammability ratings.

9100/9150 Slide Gate - Exit Lane Wiring

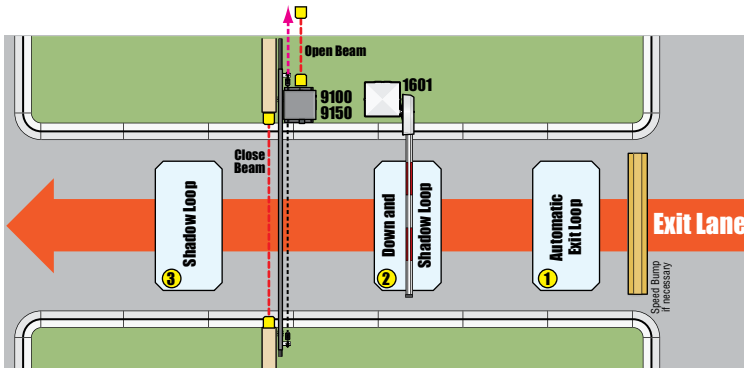

Recommended Wiring for Automatic Exit Loop

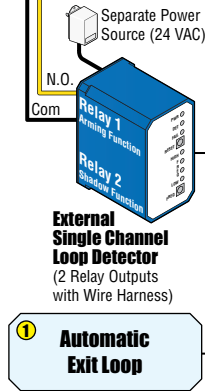
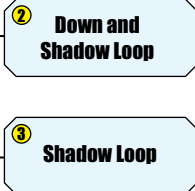
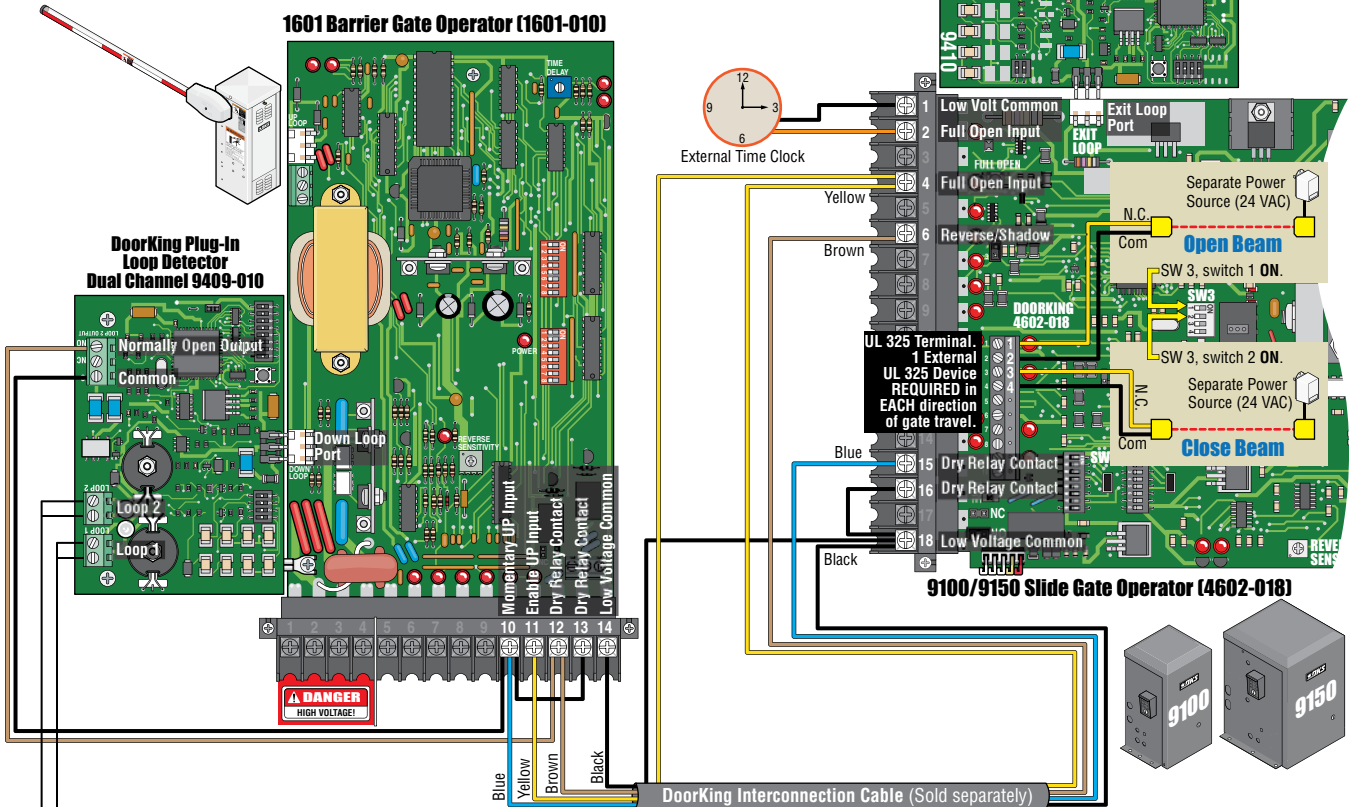
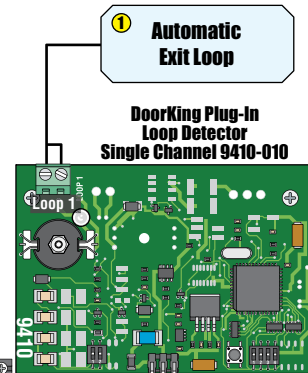

Gate Operator's Critical Settings:

1601 Barrier Gate Operator: Set Down/Reverse loop to function as Down Loop (SW 1, switch 4 ON). Set the Up input function (SW 1, switch 6 OFF). Auto-Close Timer (SW 1, switch 7 ON). Set timer at around 5-10 seconds based upon the system layout. 1601 MUST always time out and close BEFORE the 9100/9150. Set 1601 Dry Contact Relay to function with DOWN Loop detector (SW 1, switch 5 OFF). Set relay to Normally Open (NO). Works only with DoorKing Plug-In Loop Detectors.

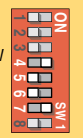

9100/9150 Swing Gate Operator: Auto-Close Timer (SW 1, switch 2 ON). Set timer long enough that the 1601 will lower arm BEFORE the 9100/9150 starts to close in ALL situations. Set Exit Loop Logic Output from Exit Loop Port to bypass terminal #10 with jumper wire connected from terminal #10 to terminal #4 (SW 2, switch 1 OFF). Set Reverse/Shadow input (SW 2, switch 2 OFF) for REVERSE function, DO NOT set for Shadow function. Set Swing/Slide gate type for Swing Gate (SW 2, switch 5 OFF). Set 9100/9150 Dry Contact Relay to activate when gate is in Full Open Position (SW 1, switches 4 & 5 OFF). Set relay to Normally Open (NO).

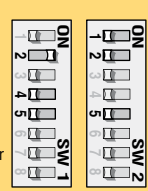

Type of wiring to be used on ALL external devices:

A) Type CL2, CL2P, CL2R, or CL2X.

B) Other cable with equivalent or better electrical, mechanical, and flammability ratings.

1175 Overhead Gate - Entry Lane Wiring

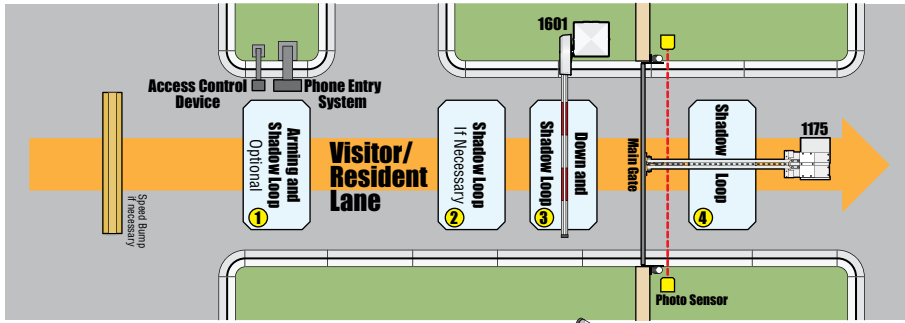

1175 Overhead Gate Operator (4405-018)

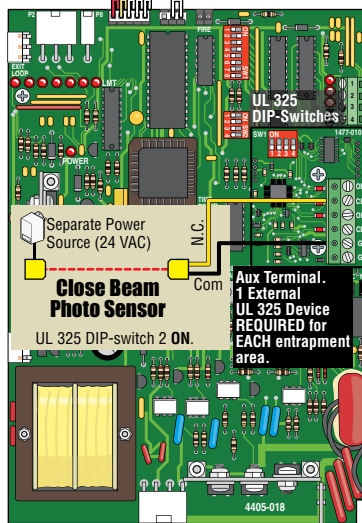

1601 Barrier Gate Operator (1601-010)

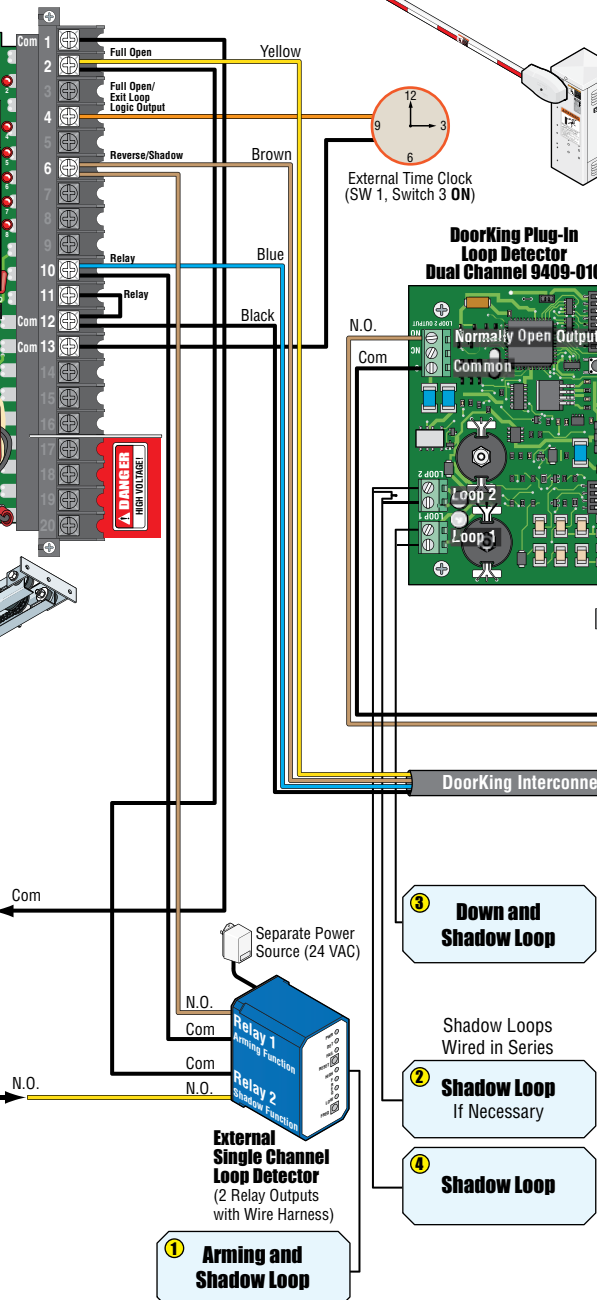
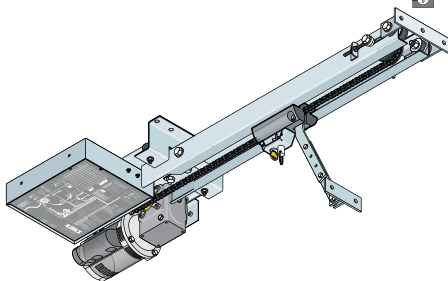
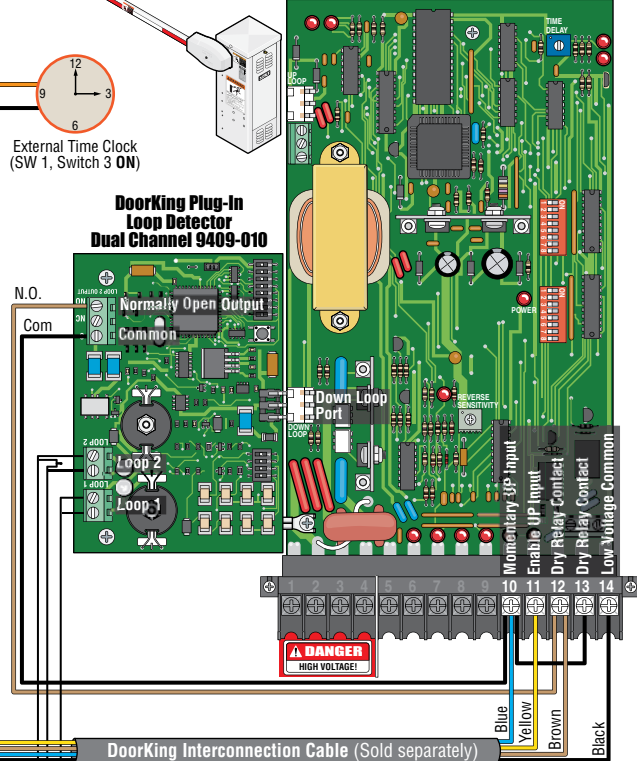

- 3 Down and Shadow Loop
- Shadow Loops Wired in Series
- 2 Shadow Loop If Necessary
- 4 Shadow Loop

- 1 Arming and Shadow Loop

Type of wiring to be used on ALL external devices:
A) Type CL2, CL2P, CL2R, or CL2X.
B) Other cable with equivalent or better electrical, mechanical, and flammability ratings.

Gate Operator's Critical Settings:

1601 Barrier Gate Operator: Set Down/Reverse loop to function as Down Loop (SW 1, switch 4 ON). Set the Up input function (SW 1, switch 6 OFF). Auto-Close Timer (SW 1, switch 7 ON). Set timer at around 5-10 seconds based upon the system layout. 1601 MUST always time out and close BEFORE the 1175. Set 1601 Dry Contact Relay to function with DOWN Loop detector (SW 1, switch 5 OFF). Set relay to Normally Open (NO). Works only with DoorKing Plug-In Loop Detectors.

1175 Overhead Gate Operator: Auto-Close Timer (SW 1, switch 4 ON). Set timer long enough that the 1601 will lower arm BEFORE the 1175 starts to close in ALL situations. Set Reverse/Shadow input (SW 1, switch 5 OFF) for REVERSE function, DO NOT set for Shadow function. Set 1175 Dry Contact Relay to activate when gate is in Full Open Position (SW 1, switches 7 & 8 OFF). Set relay to Normally Open (NO). Set Slide/Overhead gate type for Overhead Gate (SW 2, switch 3 ON).

1175 Overhead Gate - Exit Lane Wiring

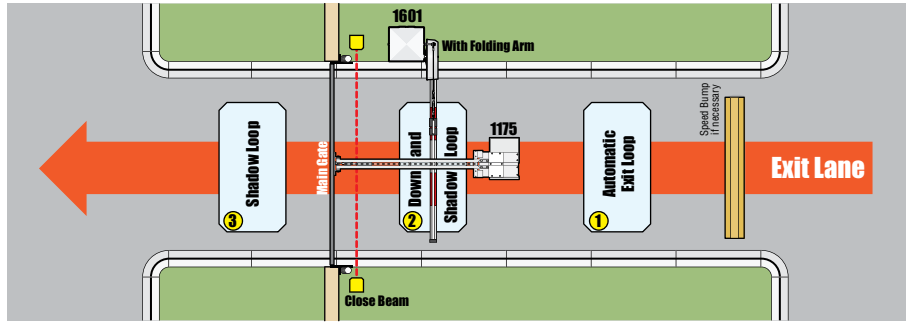

1175 Overhead Gate Operator (4405-018)

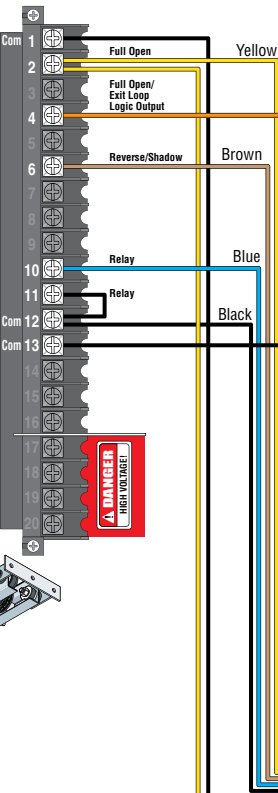
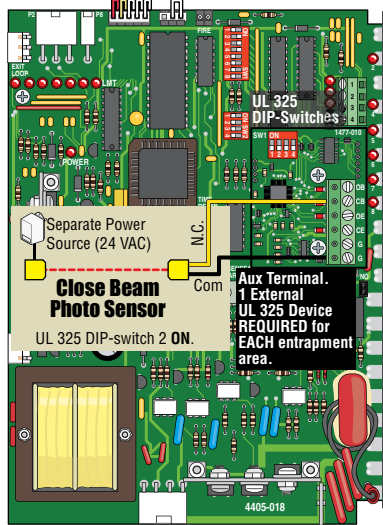

1601 Barrier Gate Operator (1601-010)

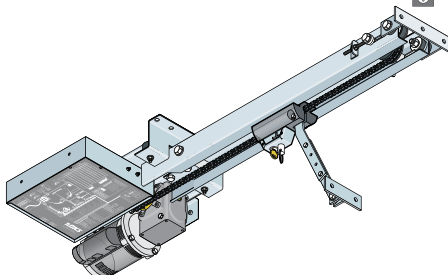
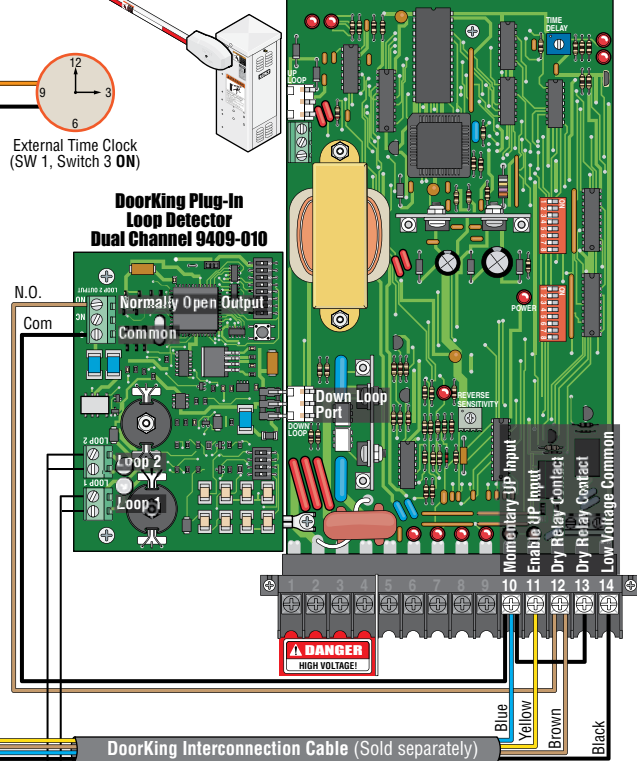

Barrier Gate Operator Folding Arm Kit

DoorKing offers a full line of aluminum, wood or plastic folding arm kits for the 1601 barrier gate operator. They are recommended for low headroom applications.

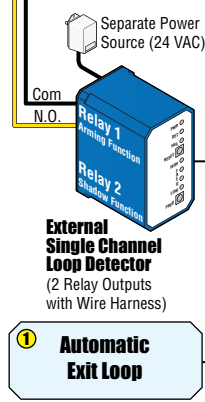
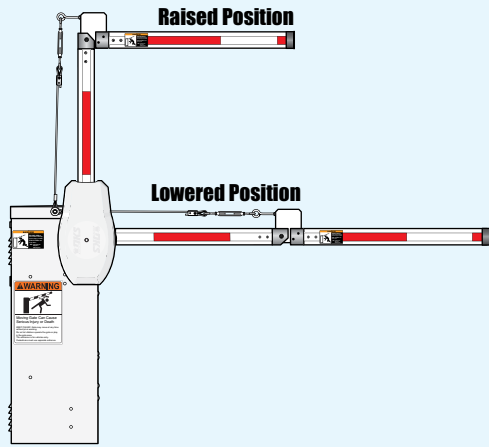

- ② Down and Shadow Loop
- ③ Shadow Loop

- ① Automatic Exit Loop

Type of wiring to be used on ALL external devices:
A) Type CL2, CL2P, CL2R, or CL2X.
B) Other cable with equivalent or better electrical, mechanical, and flammability ratings.

Gate Operator's Critical Settings:

1601 Barrier Gate Operator: Set Down/Reverse loop to function as Down Loop (SW 1, switch 4 ON). Set the Up input function (SW 1, switch 6 OFF). Auto-Close Timer (SW 1, switch 7 ON). Set timer at around 5-10 seconds based upon the system layout. 1601 MUST always time out and close BEFORE the 1175.
 Set 1601 Dry Contact Relay to function with DOWN Loop detector (SW 1, switch 5 OFF). Set relay to Normally Open (NO). Works only with DoorKing Plug-In Loop Detectors.

1175 Overhead Gate Operator: Auto-Close Timer (SW 1, switch 4 ON). Set timer long enough that the 1601 will lower arm BEFORE the 1175 starts to close in ALL situations. Set Reverse/Shadow input (SW 1, switch 5 OFF) for REVERSE function, DO NOT set for Shadow function. Set 1175 Dry Contact Relay to activate when gate is in Full Open Position (SW 1, switches 7 & 8 OFF). Set relay to Normally Open (NO). Set Slide/Overhead gate type for Overhead Gate (SW 2, switch 3 ON).



Dual 1601 Barrier Gate Operators Wiring - Bi-Parting

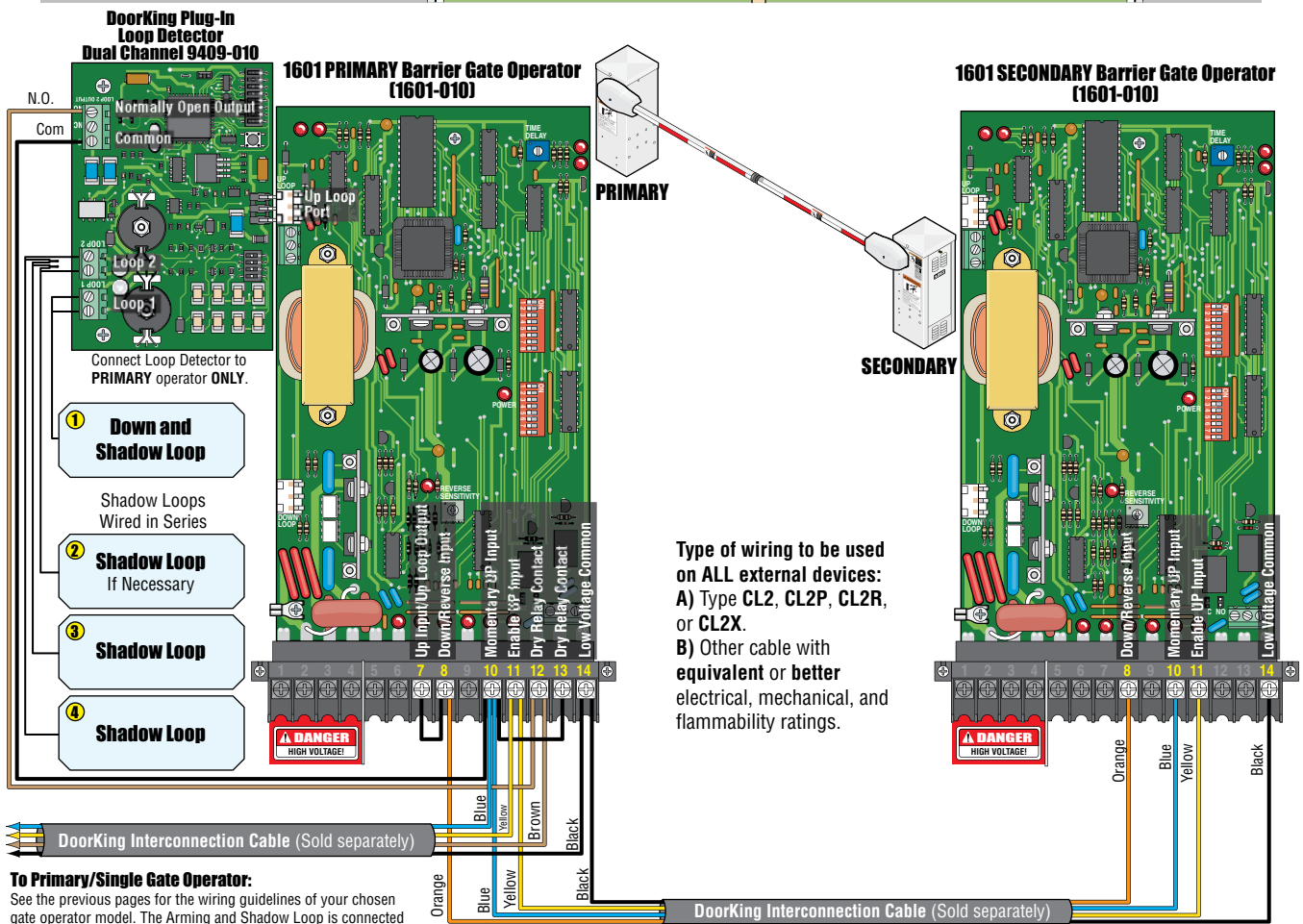
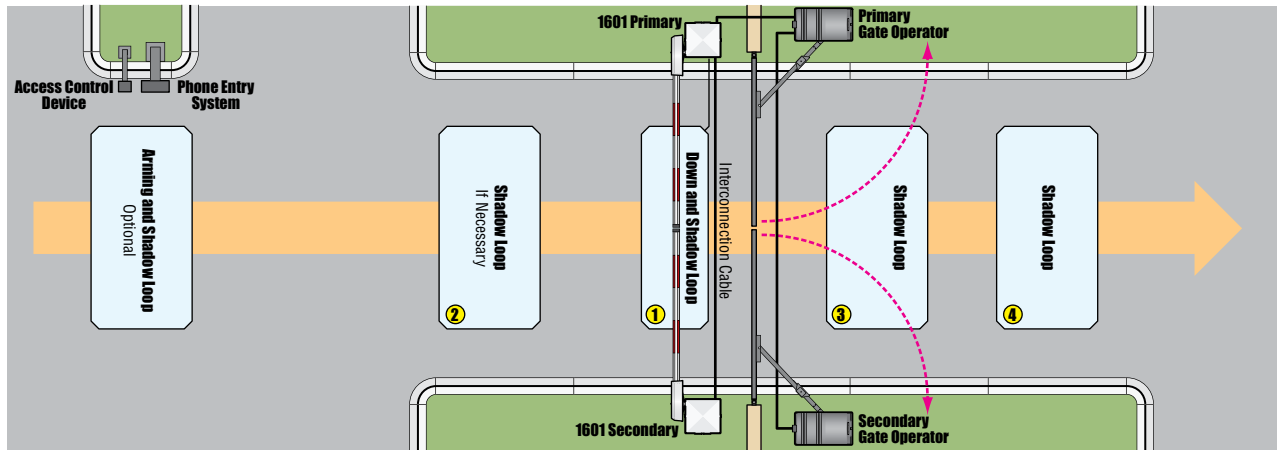

Barrier Gate Operator's Critical Settings:

1601 PRIMARY Barrier Gate Operator:

Set Down/Reverse loop to function as Down Loop (SW 1, switch 4 ON).
 Auto-Close Timer (SW 1, switch 7 ON). Set timer at around 5-10 seconds based upon the system layout. 1601 MUST always time out and close BEFORE the gate operator.
 Set SW 1, switch 8 to OFF (sends loop output to terminal #7).
 Set 1601 Dry Contact Relay to function with Up Loop detector (SW 1, switch 5 ON). Set relay to Normally Open (NO). Works only with DoorKing Plug-In Loop Detectors.



1601 SECONDARY Barrier Gate Operator:

Set Down/Reverse loop to function as Down Loop (SW 1, switch 4 ON).
 Auto-Close Timer (SW 1, switch 7 ON). Set timer to the same time as the primary barrier gate operator setting.
 Set all the other DIP-switches (SW 1 and SW 2) the SAME as the PRIMARY Barrier Gate Operator based on personal preference.



1601 "ARM UP" will Hold Open Main Gates Wiring

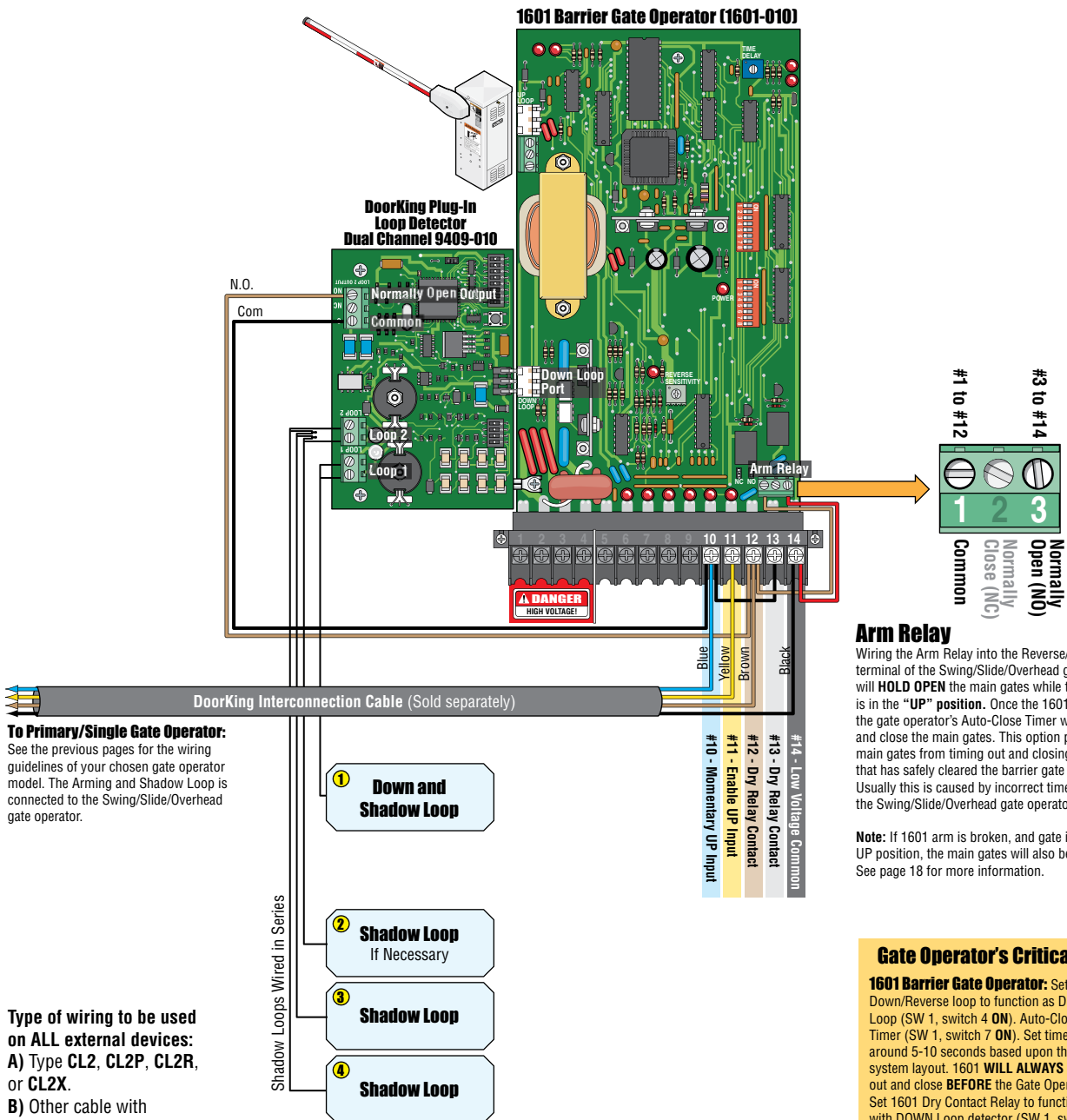
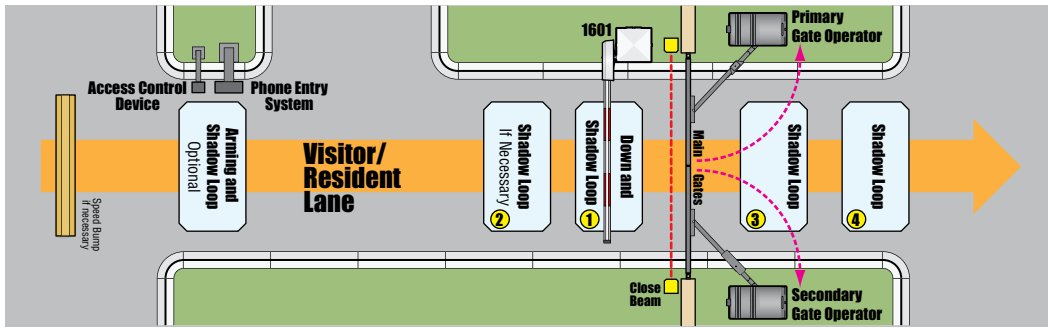

To Primary/Single Gate Operator:
See the previous pages for the wiring guidelines of your chosen gate operator model. The Arming and Shadow Loop is connected to the Swing/Slide/Overhead gate operator.

Type of wiring to be used on ALL external devices:
A) Type CL2, CL2P, CL2R, or CL2X.
B) Other cable with equivalent or better electrical, mechanical, and flammability ratings.

Shadow Loops Wired in Series

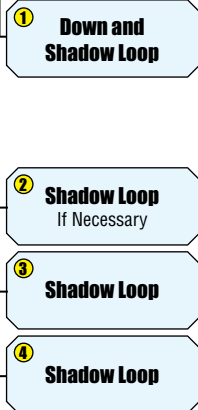

Arm Relay

Wiring the Arm Relay into the Reverse/Shadow Input terminal of the Swing/Slide/Overhead gate operator will **HOLD OPEN** the main gates while the 1601 ARM is in the "UP" position. Once the 1601 ARM lowers, the gate operator's Auto-Close Timer will count down and close the main gates. This option prevents the main gates from timing out and closing on a vehicle that has safely cleared the barrier gate operator arm. Usually this is caused by incorrect timer setting on the Swing/Slide/Overhead gate operator.

Note: If 1601 arm is broken, and gate is locked in the UP position, the main gates will also be held open. See page 18 for more information.

Gate Operator's Critical Settings:

1601 Barrier Gate Operator: Set Down/Reverse loop to function as Down Loop (SW 1, switch 4 **ON**). Auto-Close Timer (SW 1, switch 7 **ON**). Set timer at around 5-10 seconds based upon the system layout. 1601 **WILL ALWAYS** time out and close **BEFORE** the Gate Operator. Set 1601 Dry Contact Relay to function with DOWN Loop detector (SW 1, switch 5 **OFF**). Set relay to Normally Open (NO). Works only with DoorKing Plug-In Loop Detectors.

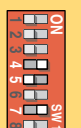

SECTION 5 - ADVANCED OPTION, INCREASE TRAFFIC FLOW

Override a "DOWN" Command for Barrier Gate Operator

The "Basic" concept of P.A.M.S. is "One vehicle enters at a time". After the main gates open, the barrier gate operator will raise **AND** lower it's arm for **EACH** authorized vehicle entering the property. However, entry traffic flow can be increased by allowing the barrier gate operator arm to remain in the UP position to allow multiple authorized vehicles to enter the property before the arm is lowered again. Each vehicle entering **MUST** have an access device (Remote transmitter, access card, etc.) to quickly activate the access control device in the P.A.M.S. system. This option works well using remote transmitters for vehicles in the **Resident** entry lane. The remote transmitters will allow quick authorized access for **EACH** vehicle, much quicker than the UP/DOWN cycle of the barrier gate operator, which will eventually back up vehicles trying to enter in the resident entry lane.

The DOWN cycle of the barrier gate operator arm can be overridden (**DIP-Switch: SW 2, switch 2 ON and switch 3 OFF**) as vehicles are entering. The arm will remain in the up position allowing multiple "Authorized Vehicles" to enter before the arm lowers again. This will increase the traffic flow during heavier traffic periods.

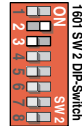

This option **CANNOT** be used at distances **OVER 12 FEET** between the access control device and the barrier gate operator (See below). This could allow more than one vehicle to be in this specific area at the same time which the barrier gate operator **WILL NOT** be able to manage.

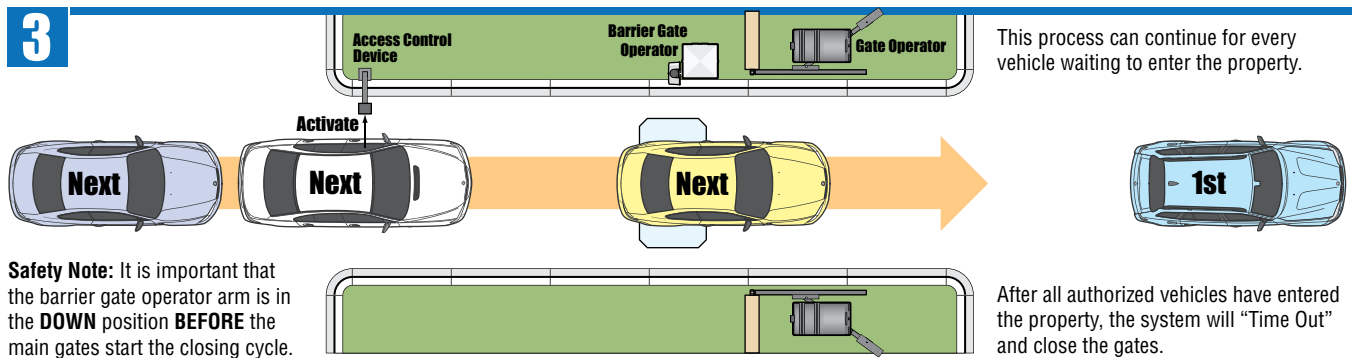
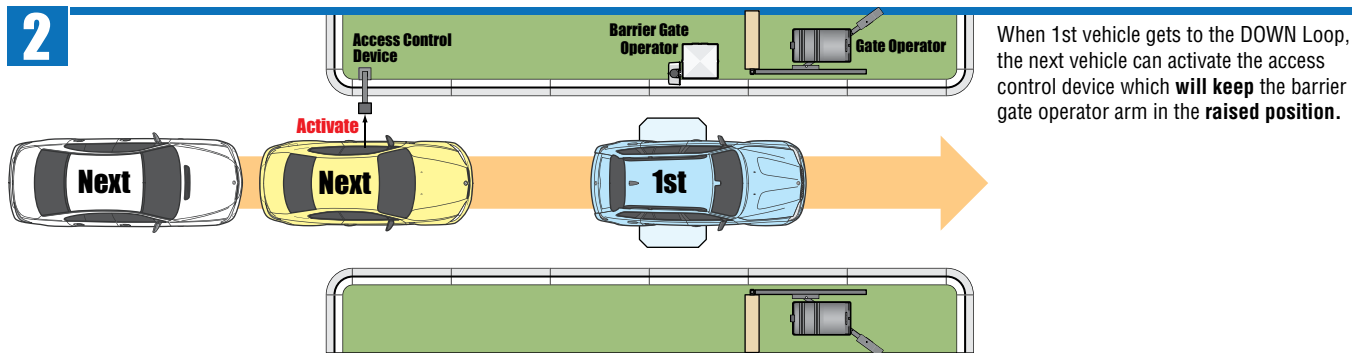
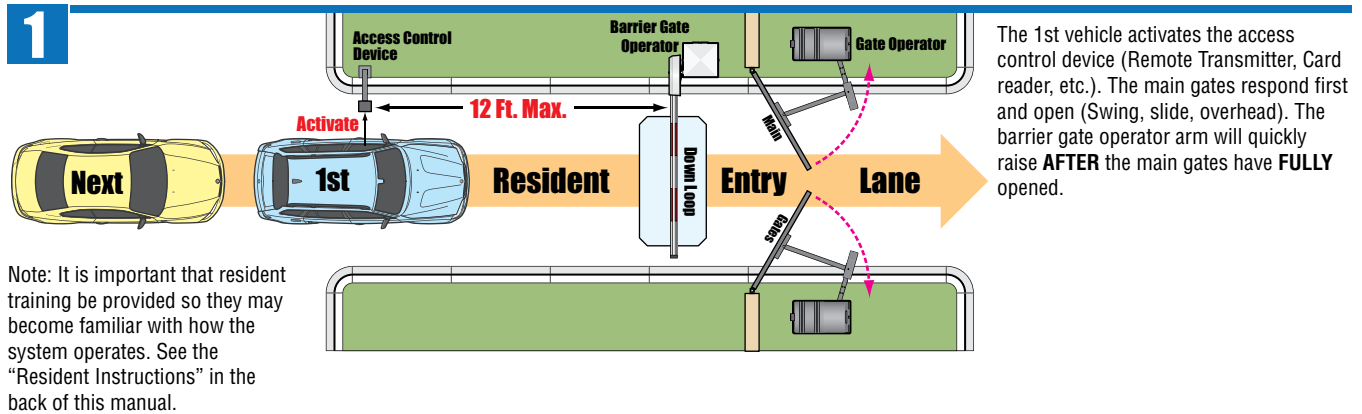

SECTION 6 - TROUBLESHOOTING

In all of these situations below, it is important that the Dealer and the Management Co. fully understand how the P.A.M.S. system is designed to operate. Ask what “Resident Training” has been provided (See “Resident Instructions” in the back of this manual). In many cases, the residents are not properly utilizing the gate system.

The Gate Hit My Car

This is probably the most common complaint from a P.A.M.S. System. It is important to identify which gate operator is involved; the 1601 Barrier Gate Operator **OR** the Swing/Slide/Overhead Gate Operator. See the next two sections below for specific information about each type of problem that may be encountered.

Barrier Gate Operator Arm Hits Vehicle:

In most cases, the P.A.M.S. system is operating as it has been designed, with the Arm closing behind **EACH** authorized vehicle, hitting the second vehicle that was attempting to enter. (Always check the system wiring, equipment locations and loop operations to ensure the system has been setup properly). We want to address this with the customer, explaining to them that **A VEHICLE WILL HIT THE ARM** if it attempts to follow (tailgate) another vehicle through the gated entrance. Advise them that this is part of the system design, not a defect with the operators. See next pages for additional suggestions.

You Also Want to Determine When and Where the Resident is Activating Their Transmitter: Example: A vehicle activates the gate system. The main gates open and the barrier gate operator arm raises. While the first vehicle is passing under the barrier gate operator arm (and is still over the down loop), a second vehicle approaches the gate area and activates their transmitter, expecting the barrier gate operator arm to remain up, they accelerate towards the barrier gate operator. However, after the first vehicle clears the DOWN Loop, **the Arm WILL come down**. The second vehicle may not have enough time to stop, hitting the Arm.

Things you can try:

- Make certain Speed Bumps or Roll Overs are placed properly to help minimize this situation.
- Set 1601 DOWN Loop for “DOWN / STOP” Function. (SW 2 switch 4 ON)
- Set 1601 for the Advanced Option (See previous page). (SW 2, switch 2 ON, SW 2 switch 3 OFF)

Swing/Slide/Overhead Gate Hits Vehicle:

This is a more serious situation. Remember, the safety for the Swing/Slide/Overhead gate **IS** the 1601 Barrier Gate Operator’s arm in the lowered position. In all situations, the 1601 **MUST** have the arm completely lowered **BEFORE** the Swing/Slide/Overhead gate **starts** its closing cycle.

Things to check:

- **Close Timing:** Make sure the 1601 Auto-Close Timer will lower the arm **prior** to the Swing/Slide/Overhead Gate timing out.
- **Loops:** Make sure all loops are wired correctly which will link them to the Swing/Slide/Overhead gate. Activation of any loop will reset the Auto-Close Timer on the gate operator, making sure that the vehicle will clear the main gates before the timer “Times Out” and closes the main gates.
- **Broken Barrier Arm:** If the Arm is broken, **shut down the system**. Since all loops are Shadow Loops, you have a situation where the main gates could start their normal closing cycle just as a slower vehicle approaches.

High Bed Vehicles / Vehicles with Trailers

Most DOWN Loops are 4’ x 6-8’. This gives you about 2 - 3’ in detection height with a field about 8’ along the path of the roadway. A high bed delivery truck may experience a detection dropout between the front and rear axles, which will result in the Arm coming down. A vehicle with a boat trailer may experience a detection drop between the rear bumper and the Trailer, again closing the Arm. DoorKing offers a free “Loop and Loop-Detectors Information Manual” PDF located at DoorKing’s web site for more information. www.doorking.com

Things you can try:

- Try utilizing a 2nd Down Loop inside the gate, or configure a longer Down loop, extending lengthwise with the flow of traffic.
- Set 1601 DOWN Loop for “DOWN / STOP” Function. (SW 2 switch 4 ON)

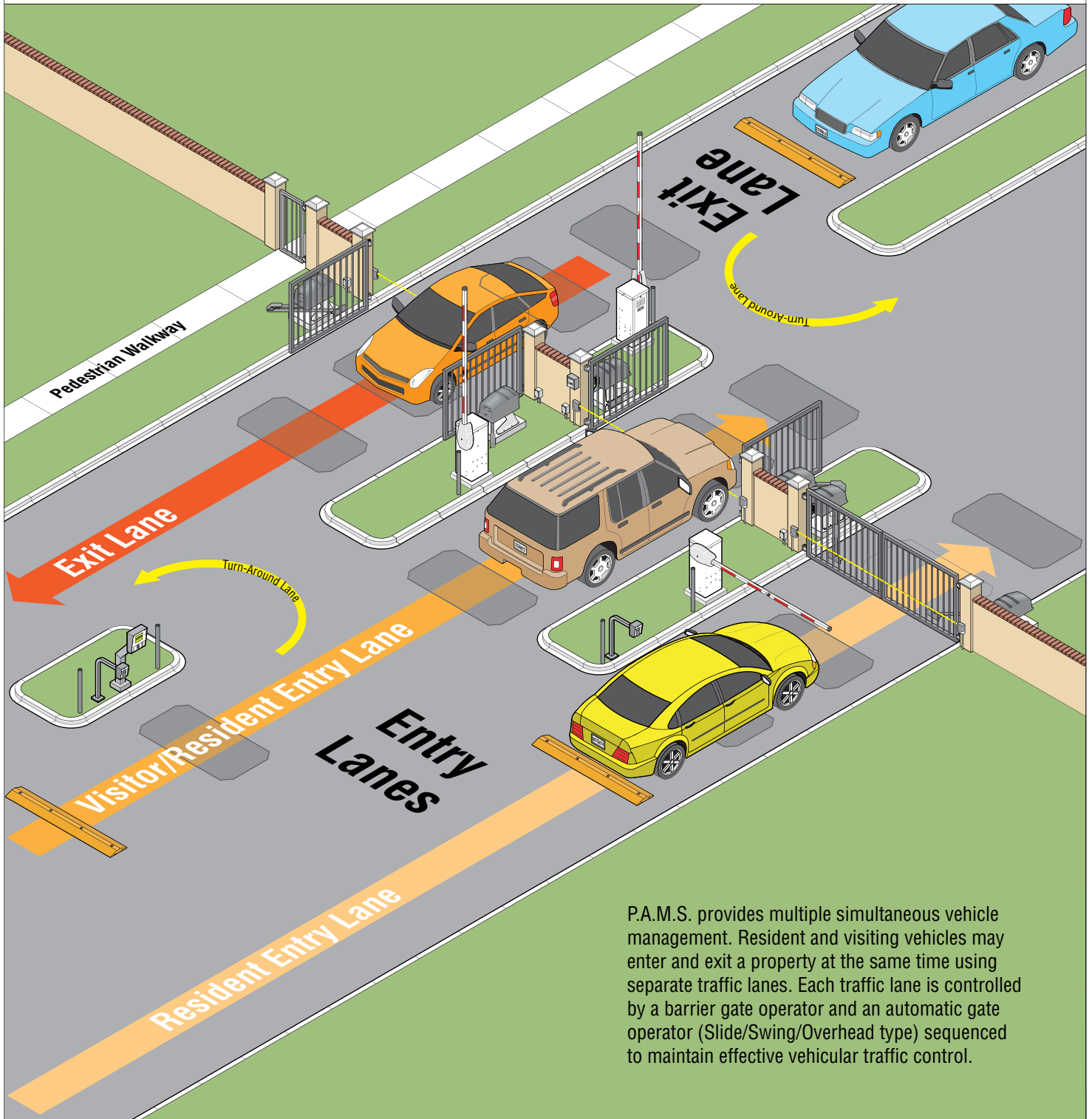

P.A.M.S. provides multiple simultaneous vehicle management. Resident and visiting vehicles may enter and exit a property at the same time using separate traffic lanes. Each traffic lane is controlled by a barrier gate operator and an automatic gate operator (Slide/Swing/Overhead type) sequenced to maintain effective vehicular traffic control.

Copyright 2019 DoorKing®, Inc. All rights reserved.

Typical 3 - Lane Traffic Operation



Visitor Access - Telephone Entry System



Telephone Entry System

A visitor can **ONLY** gain entry through the Main Gates by using the Telephone Entry System. This provides communication from the Telephone Entry System to a Resident's apartment or home telephone.

The Visitor **MUST** use the Telephone Entry System to contact the resident (A "personal" cell phone call to contact the resident **WILL NOT** allow the resident to operate the gates). The visitor can look up the resident using the "Entry System Directory" on the telephone entry system and then push the "**CALL BUTTON**". Once the resident is connected to the telephone entry system, they can **Grant Access** by dialing "**9**" on their telephone and open the main gates or **Deny Access** to the visitor by simply hanging up their telephone.

Resident Access - Access Control Device

A resident can **ONLY** open the Main Gates by activating the "**Access Control Device**" (RF Radio Receiver, Proximity Card Reader or Stand-Alone Keypad) by using their "**Access Device**" (Remote Transmitter (Clicker), Access Card or 4-Digit Entry Code) depending on the access control device being used. One of these is issued to every resident by the Management Company or Home Owners Association (HOA) that is managing the property.

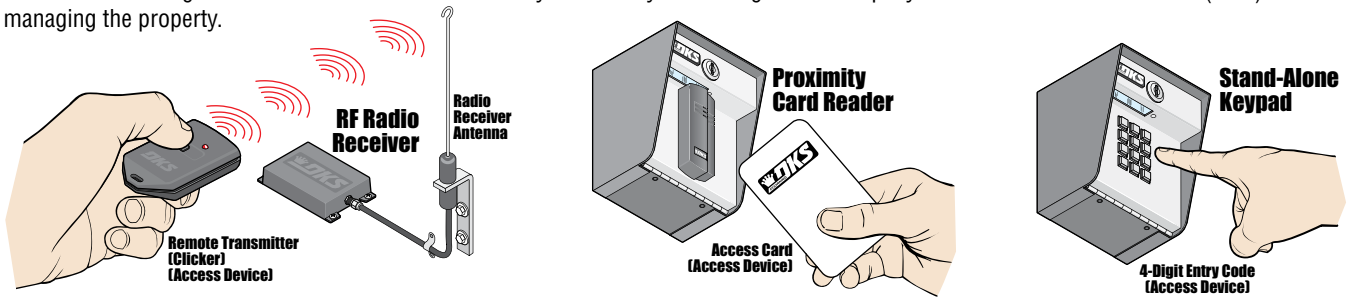

Resident Entry Procedure

Stop your car at the Access Control Device. Simply use your issued "**Access Device**" (Remote Transmitter (Clicker), Access Card or Entry Code) to activate the access control device and open the gates. **You MUST use your Access Device every time you enter.** The main gates will fully open followed by the barrier gate operator arm raising. Drive forward through the gates, **DON'T STOP or BACK-UP!** The arm and gates will automatically close after you have entered.

There are two ways you can enter the property (See **A** below and **B** on the next page):

A If you are the first car entering.....

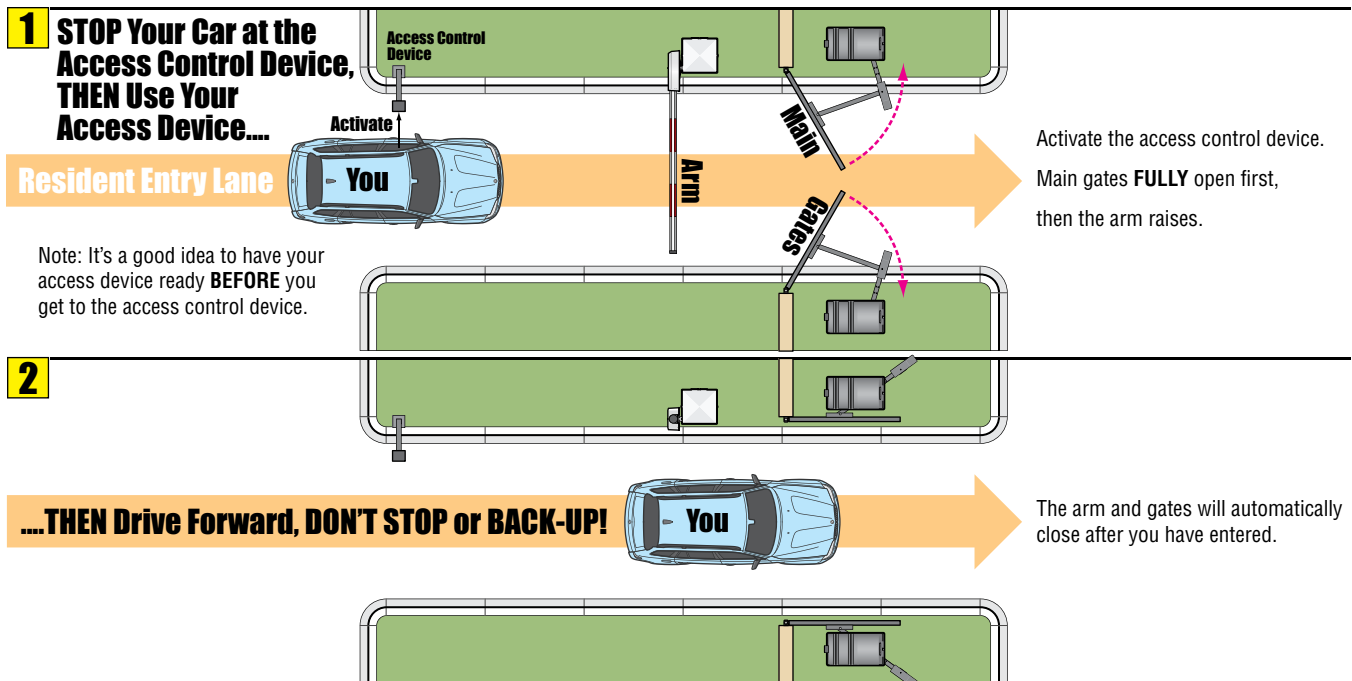

B If you are behind a car already entering....

Same procedure as the previous page but you **MUST STOP and WAIT** for the arm to lower **BEFORE** using your access device.

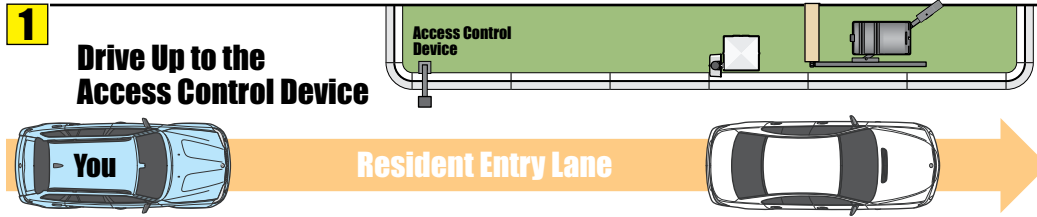

Note: It's a good idea to have your access device ready **BEFORE** you get to the access control device.

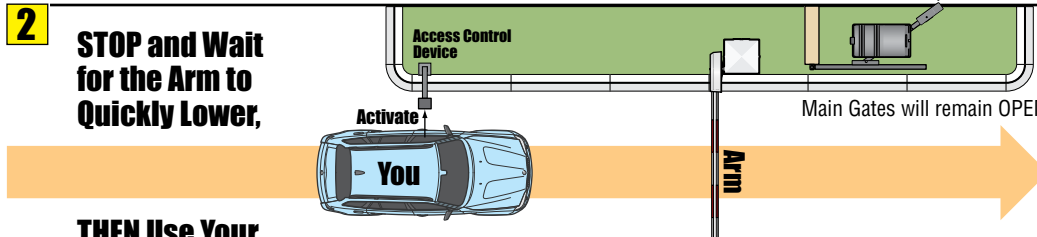

Important Note
Only **ONE** car is allowed during an open/close cycle of the arm.

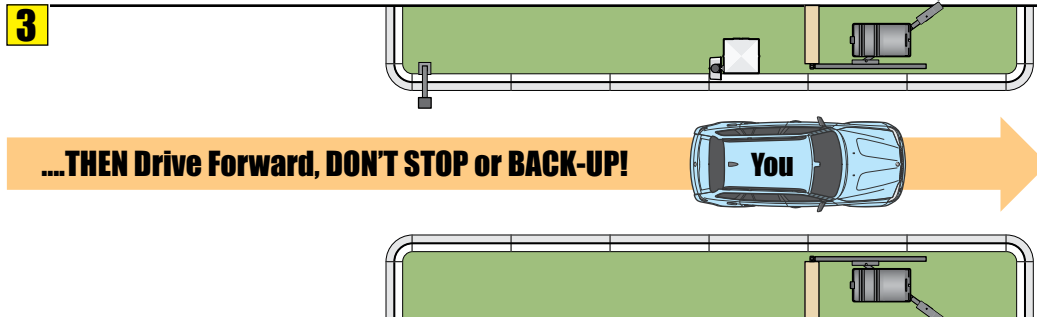

The arm and gates will automatically close after you have entered.

Exit Procedure

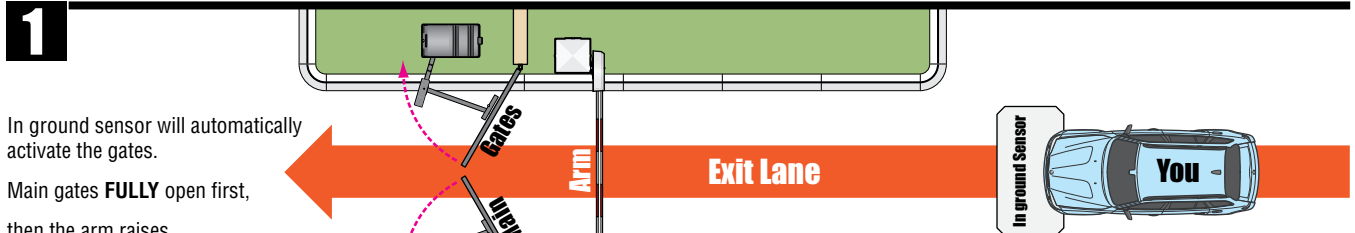

Stop on the Sensor and Wait for Gates and Arm to OPEN....

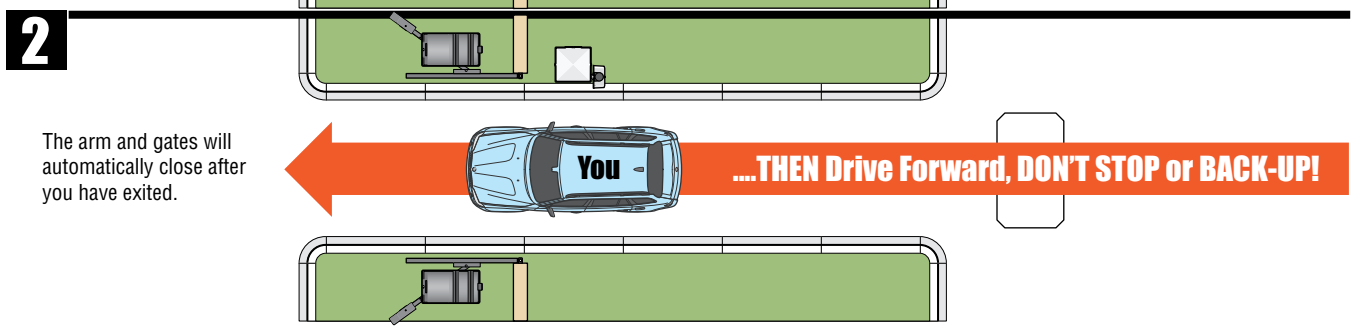

Advanced Option - Increase Entry Traffic Flow

This sequence can only be achieved if the P.A.M.S. System has been **specifically setup** to perform this advanced option and there are **multiple** cars waiting to enter the property in the **Resident Entry Lane ONLY**. The scenario below demonstrates how multiple cars will enter the property.

The 1st car will activate the Access Control Device (Usually a Radio Receiver or Card Reader) using their issued access device (Remote Transmitter (Clicker) or Access Card). **The access device MUST be used every time you enter.** The Main Gates will fully open **FIRST** followed by the barrier gate operator arm raising. The 1st car will drive forward through the gates and the next car waiting to enter will stop at the access control device and activate it. **This will keep the arm raised and allow the car that activated the access control device to drive through the gates.** The next car waiting to enter will stop at the access control device and activate it. This process can continue for each car waiting to enter. After all authorized cars have entered the property the system will automatically lower the arm first and then close the main gates.

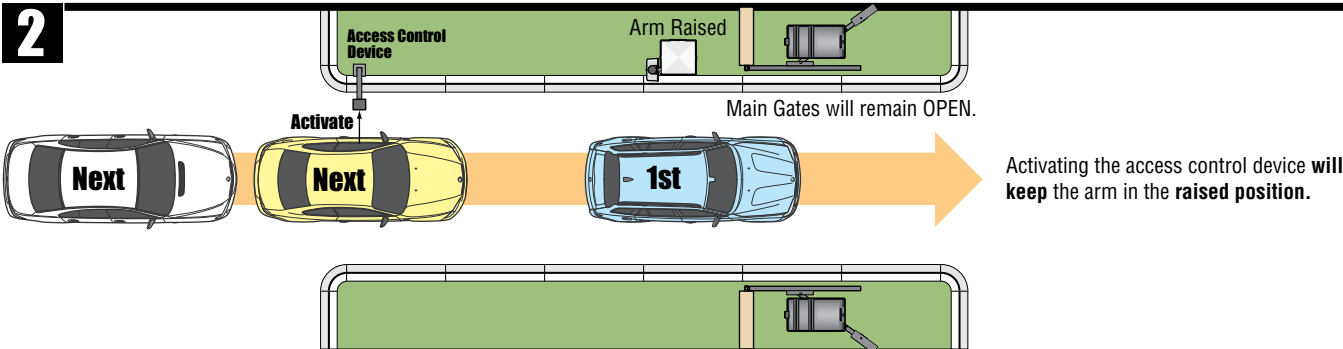
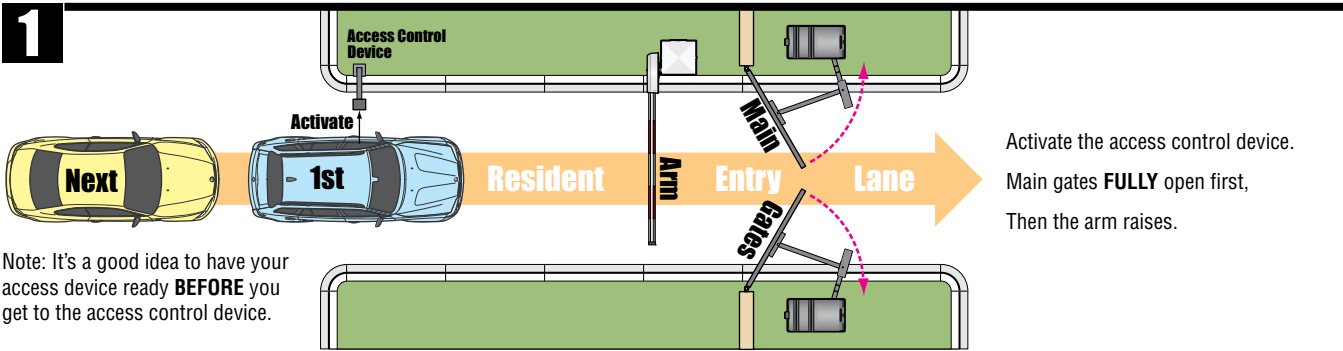

After Using Your Access Device, Drive Forward, DON'T STOP or BACK-UP!

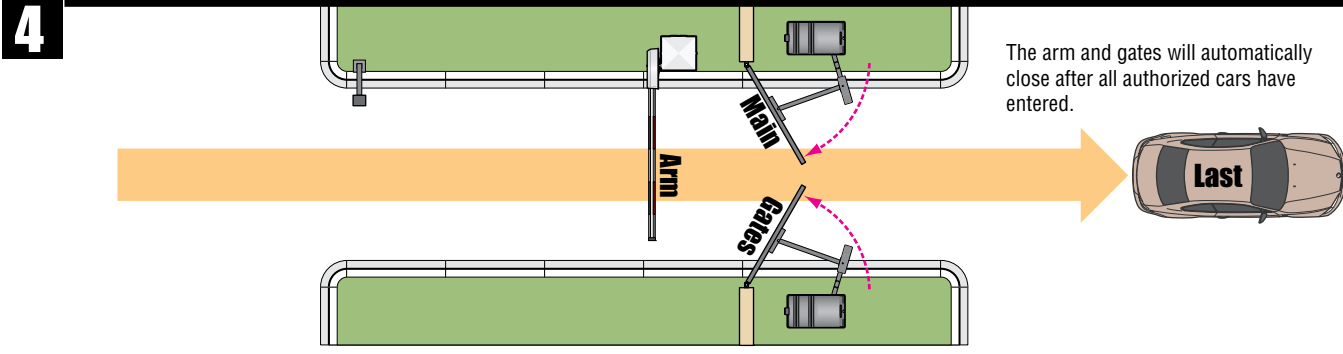
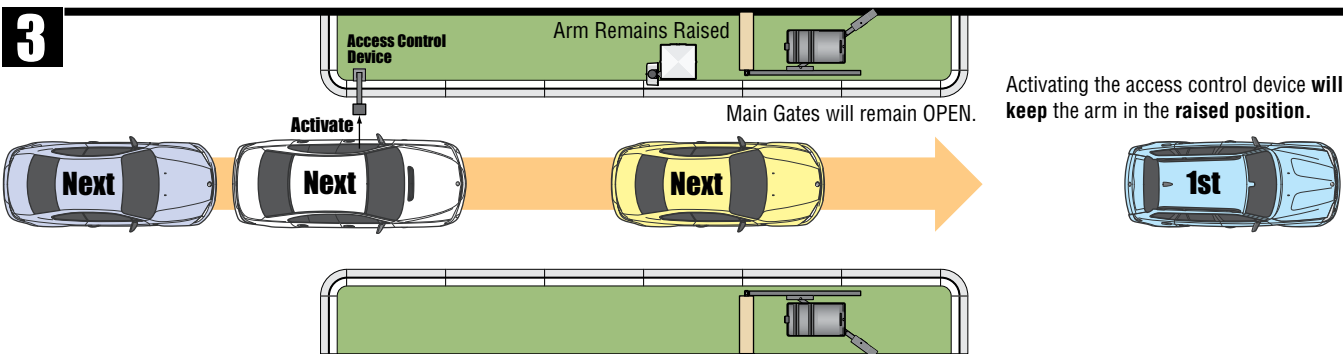

EXTERNAL ENTRAPMENT PROTECTION MUST be installed on gate operators or they WILL NOT function.

UL 325 August 2018 Standard



THIS PRODUCT IS TO BE INSTALLED AND SERVICED BY A TRAINED GATE/DOOR SYSTEMS TECHNICIAN ONLY.
Visit www.doorking.com/dealer-locator to find a professional installing and servicing dealer in your area.

www.doorking.com

DoorKing, Inc.
120 S. Glasgow Avenue
Inglewood, California 90301
U.S.A.

Phone: 310-645-0023
Fax: 310-641-1586