

Installation/Owner's Manual

Series 6050 and 6100

Vehicular Swing Gate Operator

Use this manual for circuit board 4502-018 Revision A or higher.

6050-065-X-10-23

Entrapment Protection must be provided for the gate system where the risk of entrapment or obstruction exists. The operator will not run without one or more monitored type B1 or B2 entrapment protection devices in EACH entrapment area.

UL 325 August 2018 Standard

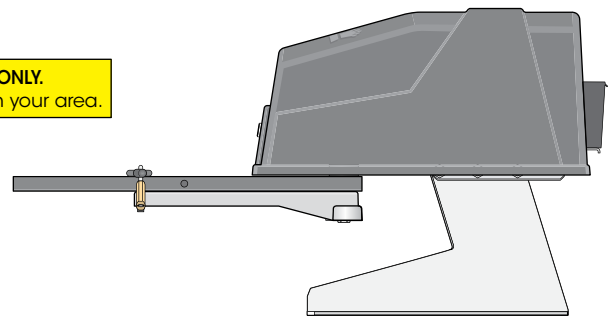
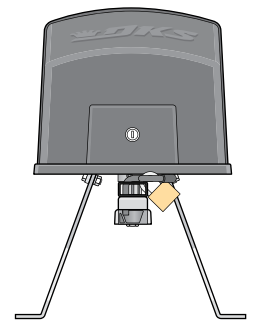
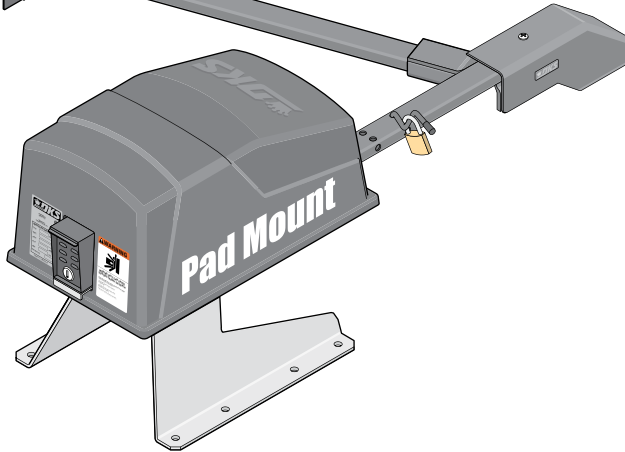
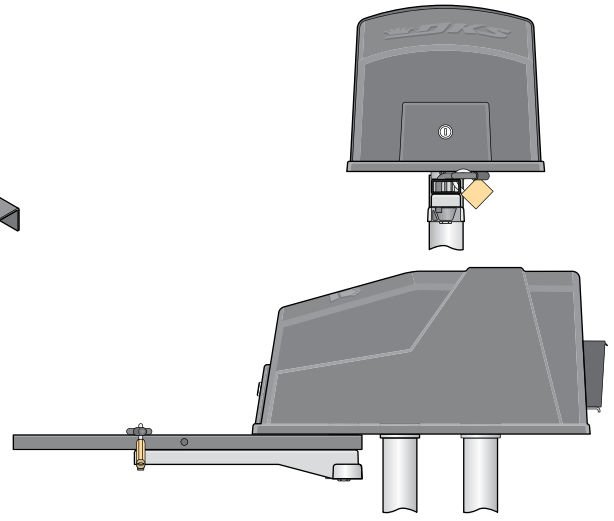
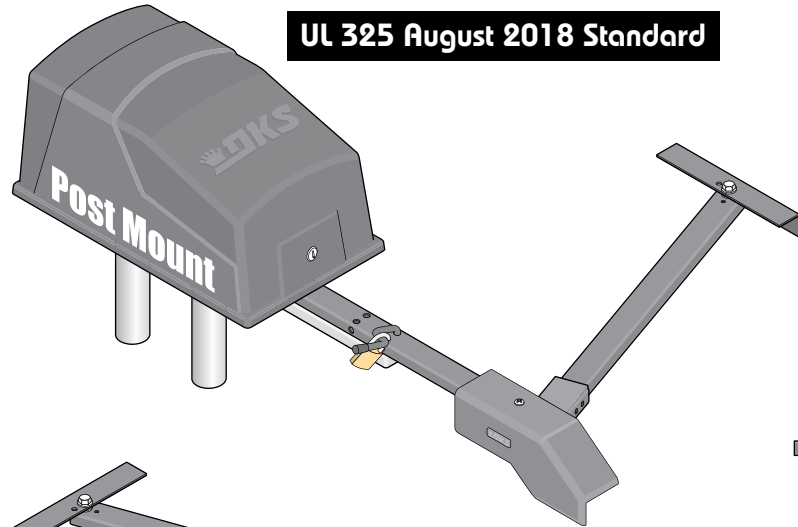

THIS PRODUCT IS TO BE INSTALLED AND SERVICED BY A TRAINED GATE/DOOR SYSTEMS TECHNICIAN ONLY.
Visit www.doorking.com/dealer-locator to find a professional installing and servicing dealer in your area.

Installer: Leave manual with property owner.

Date Installed: _____

Installer/Company Name: _____

Phone Number: _____

Circuit Board
Serial Number
and Revision Letter: _____

Property Owner: Checklist in back of manual to review and verify new installation with Installer.

Copyright 2023 DoorKing®, Inc. All rights reserved.



Conforms To UL STD 325
Certified To CSA STD C22.2 # 247



QUICK GUIDE: DIP-Switches

See page 21 for descriptions about DIP-switches.

When a switch setting is changed, **power must be turned OFF and then turned back ON** for the new setting to take affect.

⚠ Every time the operator is powered up, the First open command will automatically set the open and close limits of the gate. (See page 22).

SW 4 (Top 8 Switches)			
Switch	Function	Setting	Description
1 and 2	Circuit Board Relay	1-OFF 2-OFF	Relay activates when gate is open (Shadow loop setting when used).
		1-OFF 2-ON	Relay activates when gate is not closed.
		1-ON 2-OFF	Relay activates when gate is opening and open.
		1-ON 2-ON	Relay activates when gate is opening and closing.
3	Exit Loop Port Output	OFF	The output wired to terminal #12 becomes the output from the exit loop detector plugged into the EXIT Loop port.
	Full Open Input	ON	Normal Setting. Terminal #12 is a normal full open input.
4	Auto-Close Timer	OFF	Auto-close timer is OFF. Manual input required to close gate.
		ON	Auto-close timer is ON. Adjustable from 1-23 seconds to close gate.
5	Slide Operator	OFF	Switch must be OFF for slide gate operator (DO NOT use for 6050/6100).
	Swing Operator	ON	Normal Setting. Switch must be ON for swing gate operator.
6	3-Button	OFF	OFF when using a 3-button station (DoorKing 3-button control stations only).
	Single Button	ON	ON when using a single button control, terminals 13 & 14 become a STOP input.
7	Dual Operators	OFF	Switch must be OFF when bi-parting (dual) gates are used.
	Single Operator	ON	Switch must be ON for single operator.
8	Tamper Protect	OFF	Tamper protect is OFF.
		ON	Normal Setting. Tamper protect is ON. Operator will close gate when being forced open.

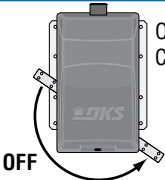
SW 3 (Bottom 8 Switches)			
Switch	Function	Setting	Description
1	Primary Gate Opening Direction		<div style="display: flex; justify-content: space-around; align-items: center;"> <div style="text-align: center;">  <p>Opens Clockwise ON</p> </div> <div style="text-align: center;">  <p>Opens Counter-Clockwise OFF</p> </div> </div>
2	Secondary Gate Opening Direction		Same as above, for secondary 6050/6100 ONLY .
3	Self-Test	OFF	Normal Setting. Normal operation.
		ON	Self-test mode. Operator MUST be disconnected from gate to run self test.
4	Single Gates OR Bi-Parting Gates	OFF	Switch is OFF when using a single operator.
		ON	Switch is ON when using dual gate operators (Primary/Secondary Bi-Parting gates).
5	Reverse	OFF	Terminal 15 is a STANDARD Reverse input.
	Shadow Loop	ON	Terminal 15 is a Shadow input. Gate will NOT stop during the close cycle.
6	Gate Overlap	OFF	Primary and secondary operators start at the same time.
		ON	Secondary operator starts 1-2 seconds prior to primary operator.
7	Monitored Close Beam	OFF	No Photo Sensor connected to Aux terminal 7 and 8.
		ON	Photo sensor is connected to Aux terminal 7 and 8 and monitored. (Close ONLY)
8	Monitored Edge/Beam	OFF	No Edge or Beam connected to Aux terminal 9 and 10.
		ON	Edge OR Beam is connected to Aux terminal 9 and 10 and monitored. (Open/Close)

QUICK GUIDE: Terminal Descriptions

See page 25 for main terminal wiring.

- When gate is closed, input will open gate.
- When gate is open and auto close timer SW 4, switch 4 is turned **ON**, input will re-set and hold timer.
- When gate is open and auto close timer SW 4, switch 4 is turned **OFF**, input will close gate.
- When gate is closing, input will **reverse** gate.



- If SW 4, **switch 3** is **ON**, functions as a normal full open input (Normal setting).
- If SW 4, **switch 3** is **OFF**, input to terminal #12 becomes the output from the EXIT loop detector plugged into the EXIT loop port. (Used for specialized functions).



This input **ONLY** functions when gate is **fully opened** or in the **closing cycle**.

- When gate is closing: SW 3, **switch 5** is **OFF**, an input to terminal #15 will **reverse** and open the gate.
Note: If the auto-close timer is **ON**, when gate reaches the open position, timer will then time out and close the gate.
- When gate is closing: SW 3, **switch 5** is **ON**, an input to terminal #15 has **NO** effect on the gate operator (Set for **Shadow** input).

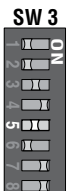

Operation of the circuit board dry relay contact is dependent on setting of SW 4, **switches 1 and 2**. **Relay contacts** can be set for Normally Open (NO) or Normally Closed (NC) operation.

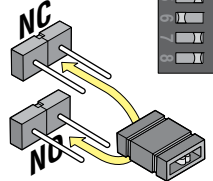

Contact rating is 1 amp maximum at 24-volts DC.

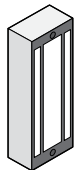
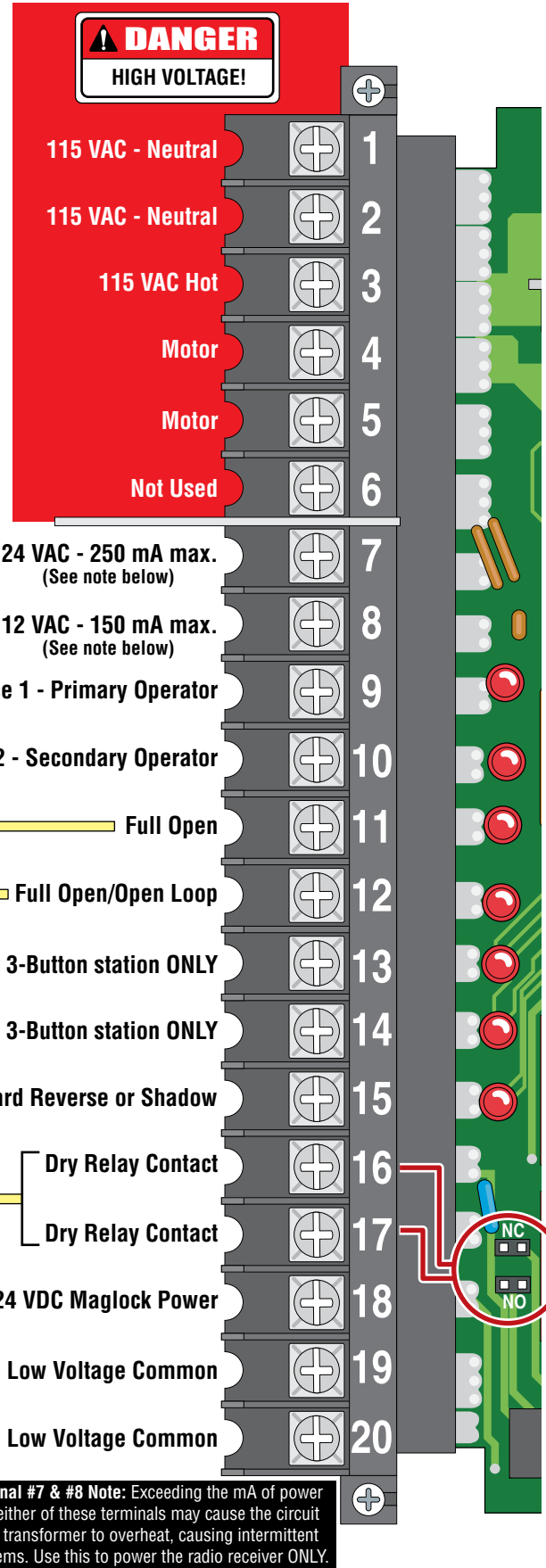

24-volt DC magnetic lock power is provided constantly except when the gate is **opening** or **open** (Normally Closed function).

6050 / 6100 SPECIFICATIONS

Use this manual for the Model 6050/6100 operators with circuit board 4502-018 Rev A or higher ONLY.

UL325 Class of Operation _____ Model 6050 Class I Only ; Model 6100 Class I, II, III, IV
 Type of Gate _____ Vehicular Swing Gates Only
 Inherent Entrapment Protection Device _____ Inherent Reverse Sensor System (Type A) - Adjustment is **NOT** needed.
 External Entrapment Protection Device Inputs _____ Connection inputs for Non-contact Sensor - Photo Sensor (Type B1)
 (Monitored Inputs) _____ Connection input for Contact Sensor - Reversing Edge (Type B2)

Entrapment Protection must be provided for the gate system where the risk of entrapment or obstruction exists. The operator will not run without one or more monitored type B1 or B2 entrapment protection devices in EACH entrapment area.

	Model #	Type Operator	Horsepower - Volts	Amp	Max Gate Weight	Max Gate Length	Cycles Per Hour	Speed 90°
6050	6050-380	Primary	1/2 HP - 115 VAC	4.3	400 Lbs.	10 Ft.	10	12-14 Sec
	6050-381	Secondary	1/2 HP - 115 VAC	4.3	400 Lbs.	10 Ft.	10	12-14 Sec
6100	6100-380	Primary	1/2 HP - 115 VAC	5.4	500 Lbs.	14 Ft.	60	12-14 Sec
	6100-381	Secondary	1/2 HP - 115 VAC	5.4	500 Lbs.	14 Ft.	60	12-14 Sec

Pad Mount Kit

P/N 2600-671

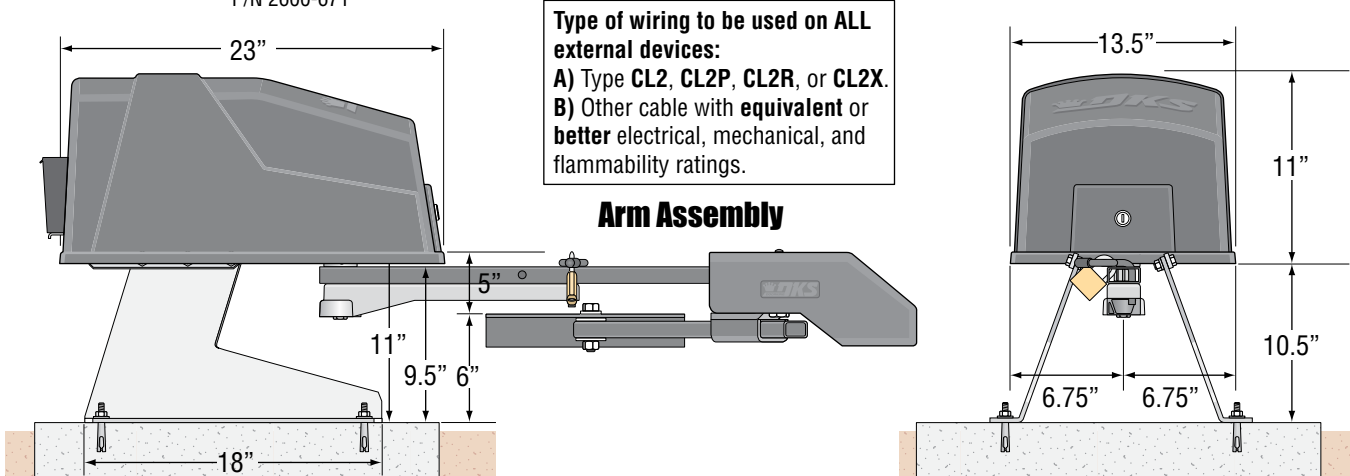

Post Mount Kit

P/N 2600-674

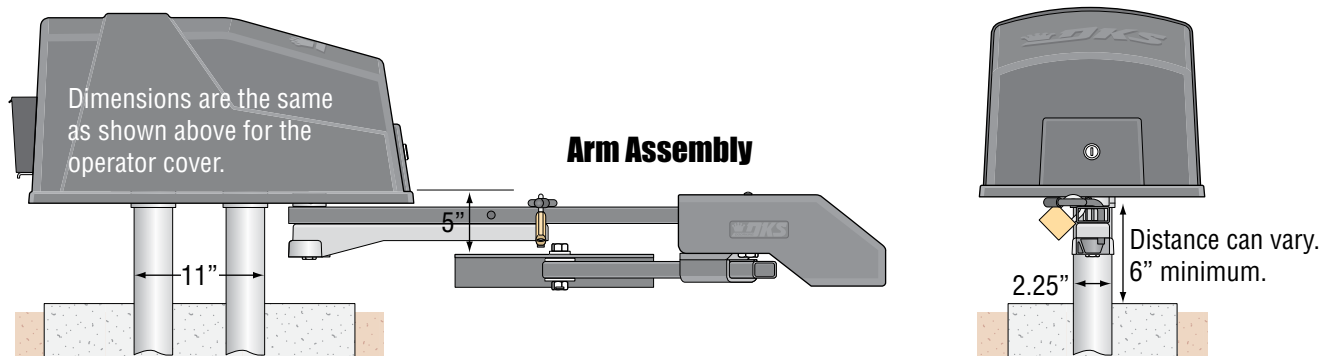

DoorKing, Inc. reserves the right to make changes in the products described in this manual without notice and without obligation of DoorKing, Inc. to notify any persons of any such revisions or changes. Additionally, DoorKing, Inc. makes no representations or warranties with respect to this manual. This manual is copyrighted, all rights reserved. No portion of this manual may be copied, reproduced, translated, or reduced to any electronic medium without prior written consent from DoorKing, Inc.

TABLE OF CONTENTS

SPECIFICATIONS

Previous Page

Swing Gate Requirements	2-3
ASTM F2200 Standard for Gate Construction	4
Important Safety Instructions	4
Instructions regarding intended installation:	4
Important Notices	5
UL 325 Entrapment Protection	6
Glossary	7
SECTION 1 - INSTALLATION	8
1.1 Operator Position	8
1.2 Post Mount or Pad Mount Base Assembly	9
1.3 Underground Conduit Requirements	10
1.4 Pad Mount	10
1.5 Post Mount	11
1.6 Arm and Gate Bracket Installation	11
1.7 Manually Adjust the Open and Closed Gate Positions	12
1.8 Installation of Warning Signs	12
1.9 Entrapment Protection Installation REQUIRED	13-14
1.10 Gates Opening Wider Than 90°	15
1.11 Overlapping Bi-Parting Gate Operator Positions	16
SECTION 2 - AC POWER TO OPERATOR(S)	17
2.1 High Voltage Wire Runs	17
2.2 High Voltage Terminal Connection	17
2.3 Bi-Parting Gates Wiring - Dual Gate Operators	18
SECTION 3 - ADJUSTMENTS	19
3.1 4502 Circuit Board Description and Adjustments	19
3.2 DIP-Switch SW 3 & SW 4 Settings	20
3.3 DIP-Switch Descriptions	21
3.4 Automatic Open / Close Limit Adjustment	22
3.5 Clutch Adjustment	23
3.6 Inherent Reverse Sensor System	23
SECTION 4 - WIRING	24
4.1 Main Terminal Description	24
4.2 Control Wiring	25
4.3 Auxiliary Terminal Wiring	26-27
4.4 Dual Gates Multiple Photo Sensors Wiring Sample	28
4.5 Loop Detector Wiring	29
SECTION 5 - OPERATING INSTRUCTIONS	30
5.1 Power and Reset Switches	30
5.2 Shutdown Conditions	31-32
5.3 Manual Gate Operation	32-33
SECTION 6 - MAINTENANCE AND TROUBLESHOOTING	34
6.1 Maintenance	34
6.2 Troubleshooting	35-36
6.3 Accessory Items	37
Model 6050/6100's Wiring Diagrams	38
SECTION 7 - OWNER OF THE GATE OPERATOR	39
7.1 Alarm Sounding OR "Chirping" and Gate WILL NOT Operate	39
7.2 Manual Gate Operation	40
7.3 Gate Operators Monthly Checkup	41
7.4 New Installation Checklist for Installer and Property Owner	42
Printable Safety Page	43

Swing Gate Requirements

This operator is intended for installation only on gates used for vehicles. Pedestrians must be supplied with a separate access opening. For pedestrian access in the vicinity of an automated vehicular gate, separate pedestrian access shall be provided or available. The pedestrian access shall be in a location such that a pedestrian shall not come in contact with a moving vehicular gate access gate during the entire path of travel of the vehicular gate. A pedestrian gate shall not be incorporated into an automated vehicular gate panel.

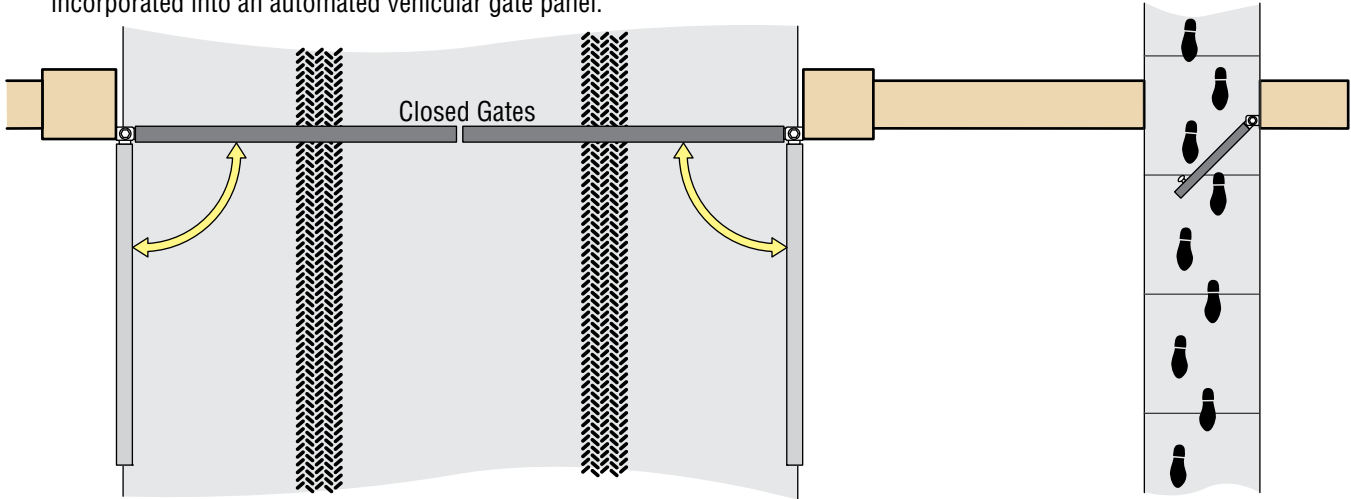

Entrapment Protection must be provided for the gate system where the risk of entrapment or obstruction exists. The operator will NOT run without one or more monitored type B1 or B2 entrapment protection devices in EACH ENTRAPMENT AREA.

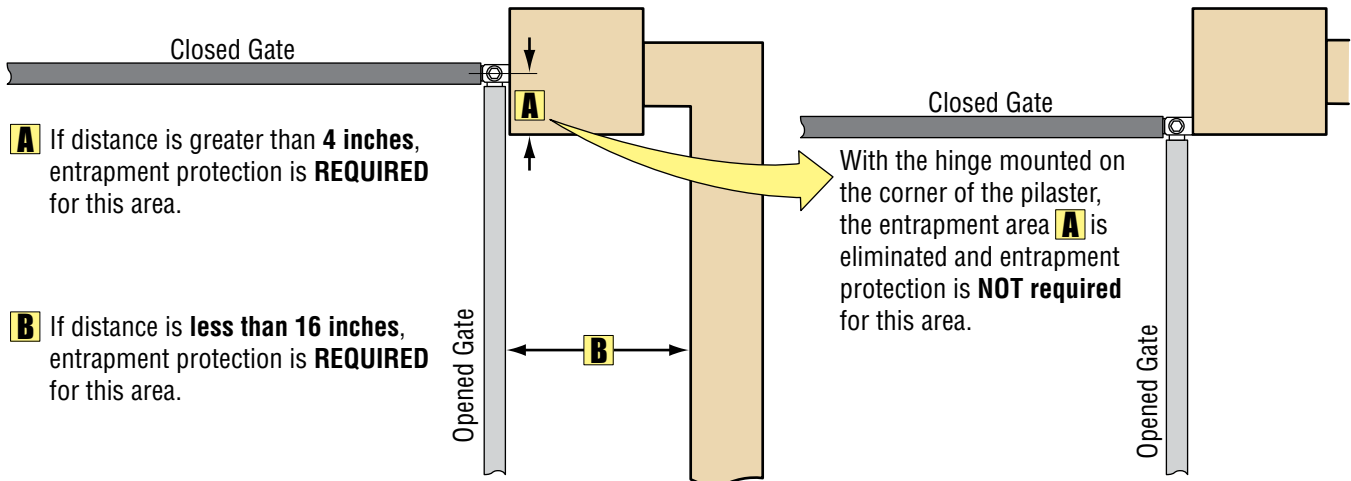

A If distance is greater than **4 inches**, entrapment protection is **REQUIRED** for this area.

B If distance is **less than 16 inches**, entrapment protection is **REQUIRED** for this area.

C If bottom of gate is **4" to 16"** above the ground at **any** part of the gate's traveling path, entrapment protection is **REQUIRED** for this area.

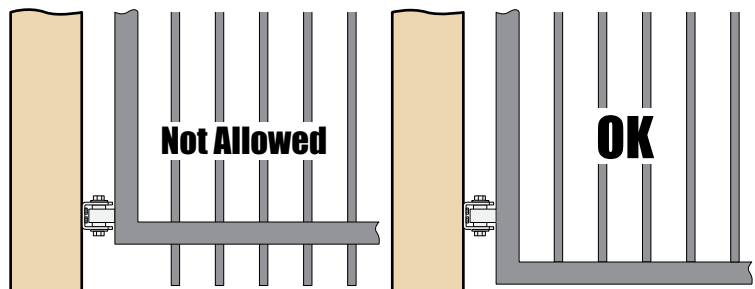
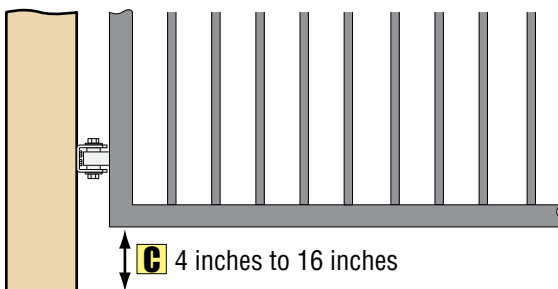

Gates shall have smooth bottom edges, with vertical bottom edged protrusions **NOT** exceeding **0.50 inches**.

Swing Gate Requirements Continued

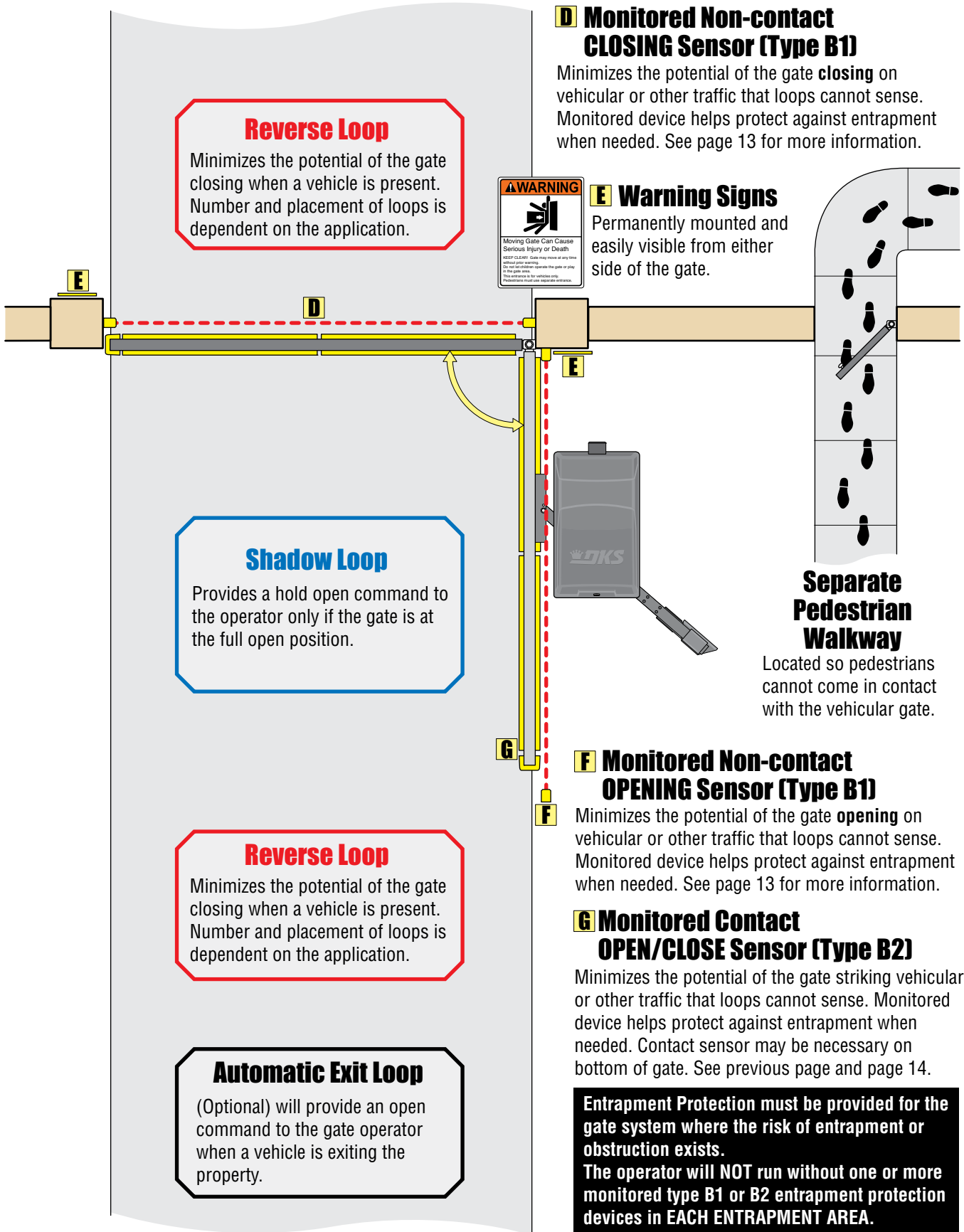

Reverse Loop
 Minimizes the potential of the gate closing when a vehicle is present. Number and placement of loops is dependent on the application.

Shadow Loop
 Provides a hold open command to the operator only if the gate is at the full open position.

Reverse Loop
 Minimizes the potential of the gate closing when a vehicle is present. Number and placement of loops is dependent on the application.

Automatic Exit Loop
 (Optional) will provide an open command to the gate operator when a vehicle is exiting the property.

D Monitored Non-contact CLOSING Sensor (Type B1)

Minimizes the potential of the gate **closing** on vehicular or other traffic that loops cannot sense. Monitored device helps protect against entrapment when needed. See page 13 for more information.



E Warning Signs

Permanently mounted and easily visible from either side of the gate.

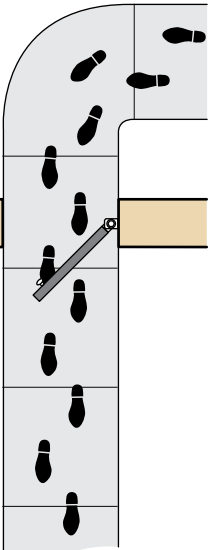

Separate Pedestrian Walkway

Located so pedestrians cannot come in contact with the vehicular gate.

F Monitored Non-contact OPENING Sensor (Type B1)

Minimizes the potential of the gate **opening** on vehicular or other traffic that loops cannot sense. Monitored device helps protect against entrapment when needed. See page 13 for more information.

G Monitored Contact OPEN/CLOSE Sensor (Type B2)

Minimizes the potential of the gate striking vehicular or other traffic that loops cannot sense. Monitored device helps protect against entrapment when needed. Contact sensor may be necessary on bottom of gate. See previous page and page 14.

Entrapment Protection must be provided for the gate system where the risk of entrapment or obstruction exists. The operator will NOT run without one or more monitored type B1 or B2 entrapment protection devices in EACH ENTRAPMENT AREA.

ASTM F2200 Standard for Gate Construction

Vehicular gates should be constructed and installed in accordance with ASTM F2200; Standard Specification for Automated Vehicular Gate Construction. For a copy of this standard, contact ASTM directly at 610-832-9585; service@astm.org; or www.astm.org.

Important Safety Instructions

WARNING - To reduce the risk of injury or death:

1. READ AND FOLLOW ALL INSTRUCTIONS.
2. Never let children operate or play with gate controls. Keep the remote control away from children.
3. Always keep people and objects away from gate. **NO ONE SHOULD CROSS THE PATH OF THE MOVING GATE.**
4. Test the operator monthly. The gate MUST reverse on contact with a rigid object or stop or reverse when an object activates the non-contact sensors. After adjusting the force or the limit of travel, retest the gate operator. Failure to adjust and retest the gate operator properly can increase the risk of injury or death.
5. Use the emergency release only when the gate is not moving.
6. KEEP GATES PROPERLY MAINTAINED. Read the owner's manual. Have a qualified service person make repairs to gate hardware.
7. The entrance is for vehicles only. Pedestrians must use separate entrance.
8. **SAVE THESE INSTRUCTIONS!**

Instructions regarding intended installation:

- Install the gate operator only if:
 1. The operator is appropriate for the construction of the gate and the usage class of the gate.
 2. All openings of a horizontal slide gate are guarded or screened from the bottom of the gate to a minimum of 6 feet (1.83 m) above the ground to prevent a 2 ¼ inch (57.2 mm) diameter sphere from passing through the openings anywhere in the gate, and in that portion of the adjacent fence that the gate covers in the open position.
 3. All exposed pinch points are eliminated or guarded.
 4. Guarding is supplied for exposed rollers.
- The operator is intended for installation only on gates used for vehicles. Pedestrians must be supplied with a separate access opening. The pedestrian access opening shall be designed to promote pedestrian usage. Locate the gate such that persons will not come in contact with the vehicular gate during the entire path of travel of the vehicular gate.
- The gate must be installed in a location so that enough clearance is supplied between the gate and adjacent structures when opening and closing to reduce the risk of entrapment. Swinging gates should not open into public access areas.
- The gate must be properly installed and work freely in both directions prior to the installation of the gate operator. Do not over-tighten the operator clutch, pressure relief valve or reduce reversing sensitivity to compensate for a damaged gate.
- For gate operators utilizing Type D protection:
 1. The gate operator controls must be placed so that the user has full view of the gate area when the gate is moving.
 2. A warning placard shall be placed adjacent to the controls.
 3. An automatic closing device (such as a timer, loop sensor, or similar device) shall not be employed.
 4. No other activation device shall be connected.
- Controls intended for user activation must be located at least six feet (6') away from any moving part of the gate and where the user is prevented from reaching over, under, around or through the gate to operate the controls. Outdoor or easily accessible controls should have a security feature to prevent unauthorized use.
- The Stop and/or Reset button must be located in the line-of-sight of the gate. Activation of the reset control shall not cause the operator to start.
- A minimum of two (2) WARNING SIGNS shall be installed, one on each side of the gate where easily visible.
- For gate operators utilizing a non-contact sensor:
 1. See the instructions on the placement of non-contact sensors for each type of application.
 2. Care shall be exercised to reduce the risk of nuisance tripping, such as when a vehicle trips the sensor while the gate is still moving in the opening direction.
 3. One or more non-contact sensors shall be located where the risk of entrapment or obstruction exist, such as the perimeter reachable by a moving gate or barrier.
- For gate operators utilizing contact sensors:
 1. One or more contact sensors shall be located where the risk of entrapment or obstruction exist, such as at the leading edge, trailing edge, and post mounted both inside and outside of a vehicular horizontal slide gate.
 2. One or more contact sensors shall be located at the bottom edge of a vehicular vertical lift gate.
 3. One or more contact sensors shall be located at the pinch point of a vehicular vertical pivot gate.
 4. A hardwired contact sensor shall be located and its wiring arranged so that the communication between the sensor and the gate operator is not subjected to mechanical damage.
 5. A wireless contact sensor such as one that transmits radio frequency (RF) signals to the gate operator for entrapment protection functions shall be located where the transmission of the signals are not obstructed or impeded by building structures, natural landscaping or similar obstructions. A wireless contact sensor shall function under the intended end-use conditions.
 6. One or more contact sensors shall be located at the bottom edge of a vertical barrier (arm).
- Be sure you have instructed the owner of the gate operator about safe and proper operation and testing of the gate operator.

Important Notices

Vehicular gate operator products provide convenience and security. However, gate operators must use high levels of force to move gates and most people underestimate the power of these systems and do not realize the potential hazards associated with an incorrectly designed or installed system. These hazards may include:

- Pinch points
- Entrapment areas
- Reach through hazards
- Absence of entrapment protection devices
- Improperly located access controls
- Absence of vehicle protection devices
- Absence of controlled pedestrian access

In addition to these potential hazards, automated vehicular gate systems must be installed in accordance with the UL 325 Safety Standard and the ASTM F2200 Construction Standard. Most people are unaware of, or are not familiar with, these standards. If an automated vehicular gate system is not properly designed, installed, used and maintained, serious injuries or death can result. Be sure that the installer has instructed you on the proper operation of the gate and gate operator system.

Be sure that the installer has trained you on proper and safe operation of this gate operating system and about the basic functions of the required reversing systems associated with your gate operating system and how to test them (see section 7). These include reversing loops, inherent reversing system, electric edges, photoelectric cells, or other external devices.

- This Owner's Manual is your property. Keep it in a safe place for future reference.
- Be sure that all access control devices are installed a minimum distance of 6 feet away from the gate and gate operator, or in such a way that a person cannot touch the gate or gate operator while using the device. If access control devices are installed in violation of these restrictions, immediately remove the gate operator from service and contact your installing dealer.

Opening device MUST be mounted a minimum of 6 feet from the gate and NOT accessible through the gate!



- Loops and loop detectors, photo-cells or other equivalent devices must be installed to prevent the gate from closing on vehicular traffic.
- The speed limit for vehicular traffic through the gate area is 5 MPH. Install speed bumps and signs to keep vehicular traffic from speeding through the gate area. Failure to adhere to posted speed limits can result in damage to the gate, gate operator, and to the vehicle.
- Be sure that all persons who will use the gate system are familiar with the proper use of the gate and gate operator and are familiar with the possible hazards associated with the gate system.
- Be sure that warning signs are permanently installed on both sides of the gate in an area where they are fully visible to traffic.
- It is your responsibility to periodically check all entrapment protection devices. If any of these devices are observed to function improperly, remove the operator from service immediately and contact your installing or servicing dealer.
- Follow the recommended maintenance schedule.
- Do not allow children to play in the area of the operator or to play with any gate-operating device.
- To remove the gate operator from service, operate the gate to the full open position and then shut off power to the operator at the service panel.

UL 325 Entrapment Protection

UL 325 Classifications



Class I - Residential Vehicular Gate Operator

A vehicular gate operator (or system) intended for use in garages or parking areas associated with a residence of one-to four single families.

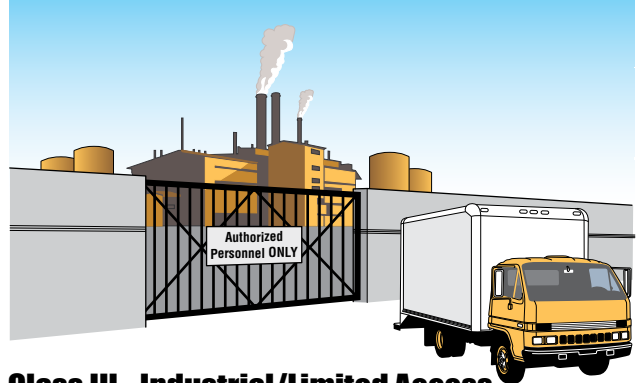

Class III - Industrial/Limited Access Vehicular Gate Operator

A vehicular gate operator (or system) intended for use in an industrial location or building such as a factory or loading dock area or other locations not accessible by or intended to service the general public.

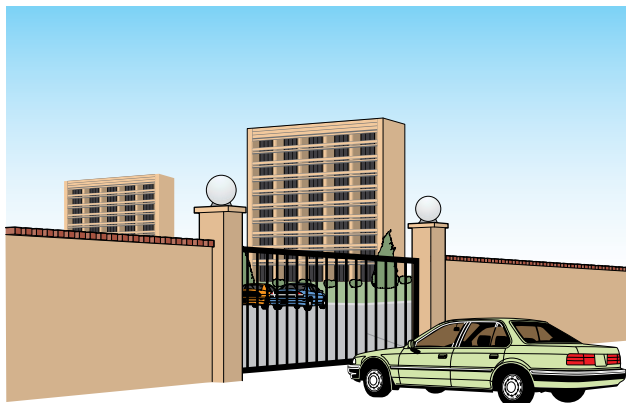

Class II - Commercial/General Access Vehicular Gate Operator

A vehicular gate operator (or system) intended for use in a commercial location or building such as a multi-family housing unit (five or more single family units), hotel, garages, retail store, or other buildings accessible by or servicing the general public.



Class IV - Restricted Access Vehicular Gate Operator

A vehicular gate operator (or system) intended for use in a guarded industrial location or building such as an airport security area or other restricted access locations not servicing the general public, in which unauthorized access is prevented via supervision by security personnel.

Gate Operator Category

Effective January 12, 2016	Horizontal Slide, Vertical Lift, Vertical Pivot	Swing, Vertical Barrier (Arm)
Entrapment Protection Types	A, B1*, B2* or D	A, B1*, B2*, C or D

- Type A** - Inherent entrapment protection system.
- Type B1** - Non-contact sensor (photoelectric sensor or the equivalent).
- Type B2** - Contact sensor (edge device or equivalent).
- Type C** - Inherent force limiting, inherent adjustable clutch or inherent pressure relief device.
- Type D** - Actuating device requiring constant pressure to maintain opening or closing motion of the gate.

* B1 and B2 means of entrapment protection must be MONITORED.

Vertical Barrier Note: Barrier gate operators (arm) that is not intended to move toward a rigid object closer than 16 inches (406 mm) are not required to be provided with a means of entrapment protection.

Glossary

GATE - A moving barrier such as a swinging, sliding, raising, lowering, or the like, barrier, that is a stand-alone passage barrier or is that portion of a wall or fence system that controls entrance and/or egress by persons or vehicles and completes the perimeter of a defined area.

RESIDENTIAL VEHICULAR GATE OPERATOR – CLASS I - A vehicular gate operator (or system) intended for use in a home of one-to four single family dwelling, or garage or parking area associated therewith.

COMMERCIAL / GENERAL ACCESS VEHICULAR GATE OPERATOR - CLASS II - A vehicular gate operator (or system) intended for use in a commercial location or building such as a multi-family housing unit (five or more single family units), hotels, garages, retail store, or other building servicing the general public.

INDUSTRIAL / LIMITED ACCESS VEHICULAR GATE OPERATOR - CLASS III - A vehicular gate operator (or system) intended for use in an industrial location or building such as a factory or loading dock area or other locations not intended to service the general public.

RESTRICTED ACCESS VEHICULAR GATE OPERATOR - CLASS IV - A vehicular gate operator (or system) intended for use in a guarded industrial location or building such as an airport security area or other restricted access locations not servicing the general public, in which unauthorized access is prevented via supervision by security personnel.

VEHICULAR BARRIER (ARM) OPERATOR (OR SYSTEM) - An operator (or system) that controls a cantilever type device (or system), consisting of a mechanical arm or barrier that moves in a vertical arc, intended for vehicular traffic flow at entrances or exits to areas such as parking garages, lots or toll areas.

VEHICULAR HORIZONTAL SLIDE-GATE OPERATOR (OR SYSTEM) - A vehicular gate operator (or system) that controls a gate which slides in a horizontal direction that is intended for use for vehicular entrance and exit to a drive, parking lot, or the like.

VEHICULAR SWING-GATE OPERATOR (OR SYSTEM) - A vehicular gate operator (or system) that controls a gate which moves in an arc in a horizontal plane that is intended for use for vehicular entrance and exit to a drive, parking lot, or the like.

SYSTEM - In the context of these requirements, a system refers to a group of interacting devices intended to perform a common function.

WIRED CONTROL - A control implemented in a form of fixed physical interconnections between the control, the associated devices, and an operator to perform predetermined functions in response to input signals.

WIRELESS CONTROL - A control implemented in means other than fixed physical interconnections (such as radio waves or infrared beams) between the control, the associated devices, and an operator to perform predetermined functions in response to input signals.

INHERENT ENTRAPMENT PROTECTION SYSTEM - A system, examples being a motor current or speed sensing system, which provides protection against entrapment upon sensing an object and is incorporated as a permanent and integral part of the operator.

EXTERNAL ENTRAPMENT PROTECTION DEVICE - A device, examples being an edge sensor, a photoelectric sensor, or similar entrapment protection device, which provides protection against entrapment when activated and is not incorporated as a permanent part of an operator.

ENTRAPMENT - The condition when an object is caught or held in a position that increases the risk of injury.

SECTION 1 - INSTALLATION

Prior to beginning the installation of the swing gate operator, we suggest that you become familiar with the instructions, illustrations, and wiring guide-lines in this manual. This will help insure that your installation is performed in an efficient and professional manner compliant with UL 325 safety and ASTM F2200 construction standards.

The proper installation of the vehicular swing gate operator is an extremely important and integral part of the overall access control system. Check all local building ordinances and building codes prior to installing this operator. Be sure your installation is in compliance with local codes.

1.1 Operator Position

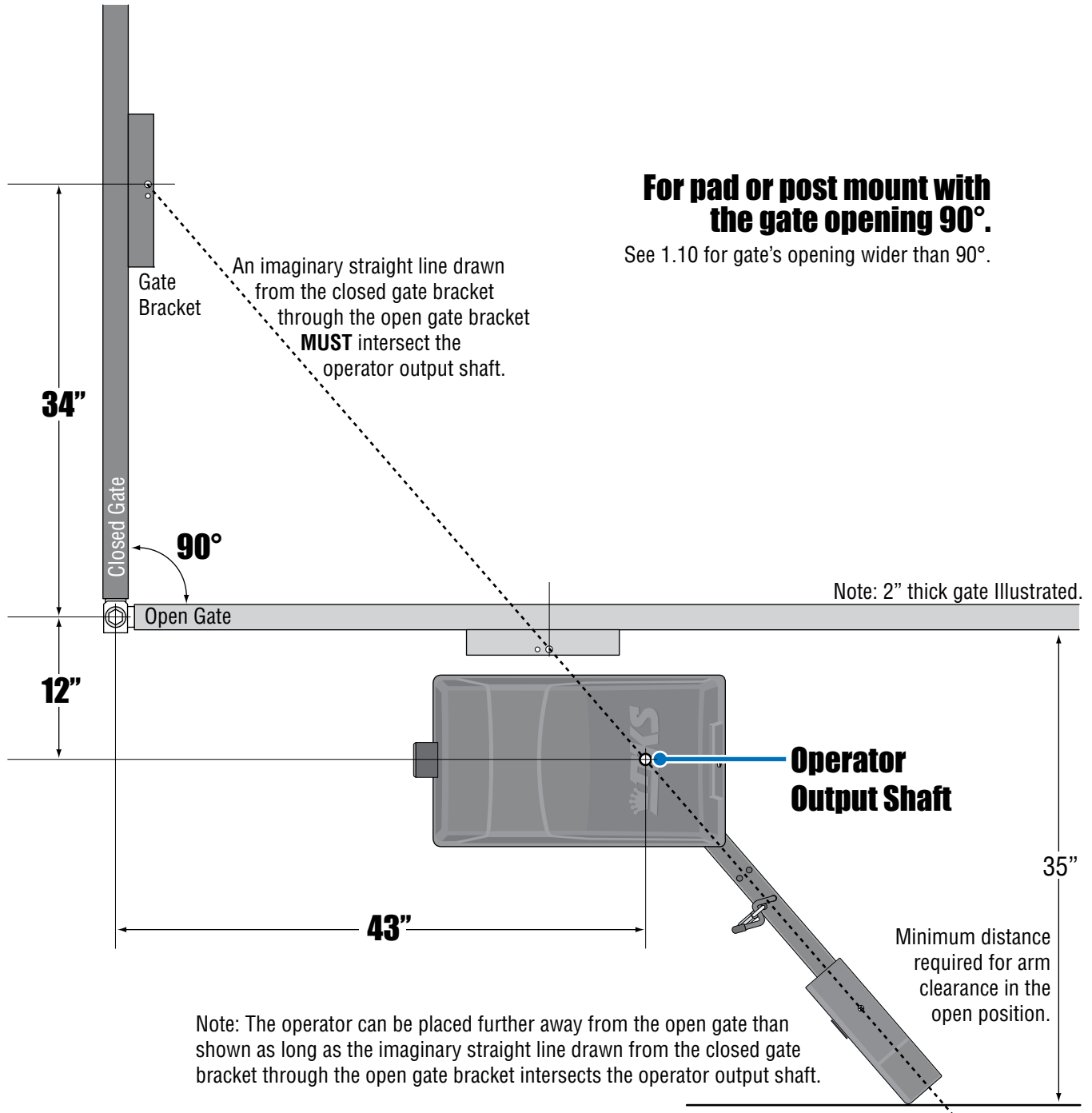

1.2 Post Mount or Pad Mount Base Assembly

Post Support Base

Screw the posts to the support plate and mount into concrete **BEFORE** attaching the operator.

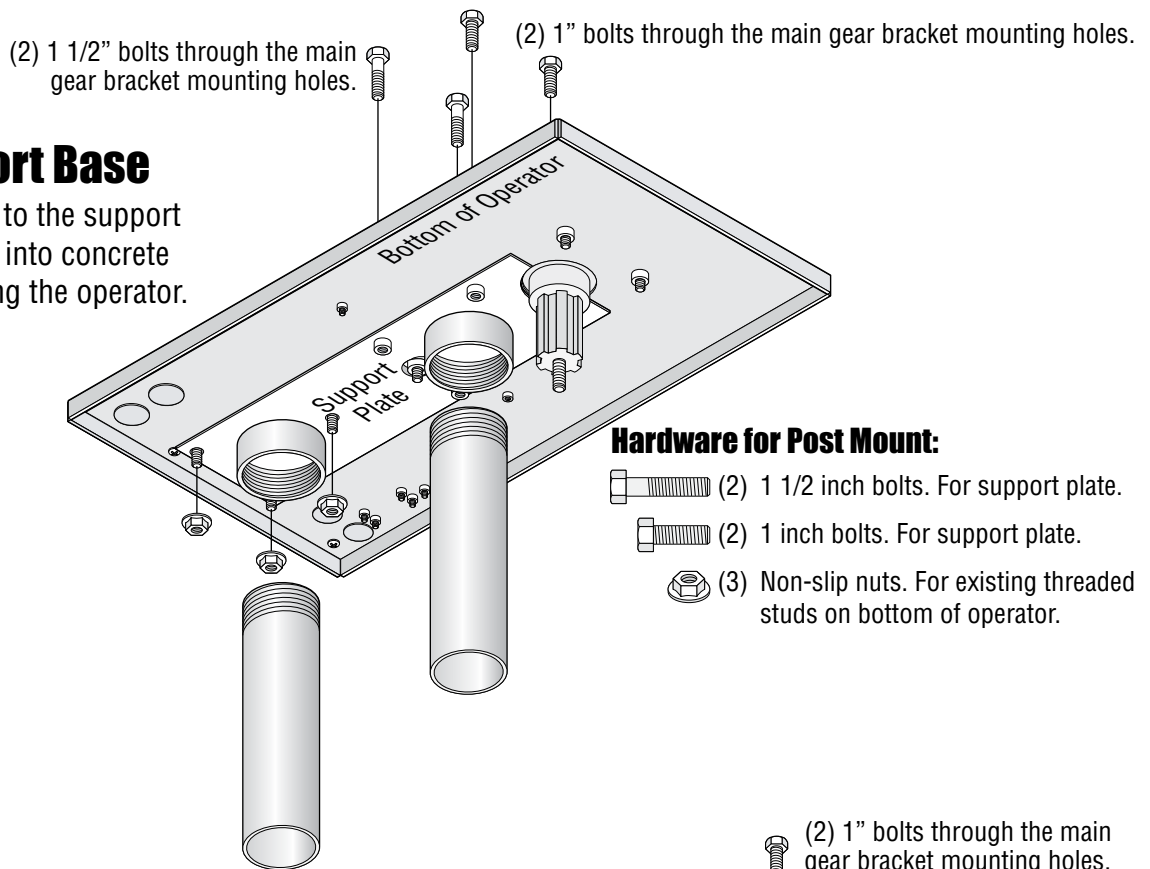

Pad Support Base

Remove the cover from the operator and **GENTLY** place the operator on its side before attaching the pad base.

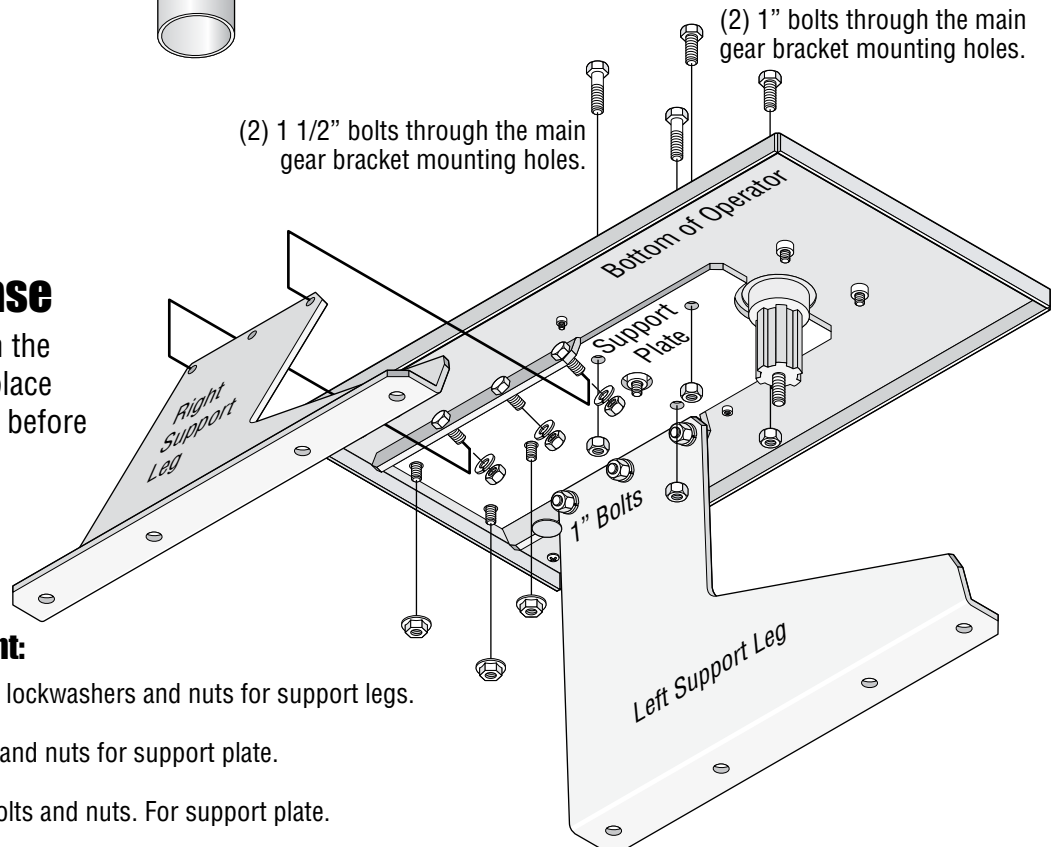

Hardware for Pad Mount:

- (6) 1 inch bolts, lockwashers and nuts for support legs.
- (2) 1 inch bolts and nuts for support plate.
- (2) 1 1/2 inch bolts and nuts. For support plate.
- (3) Non-slip nuts. For existing threaded studs on bottom of operator.

1.3 Underground Conduit Requirements

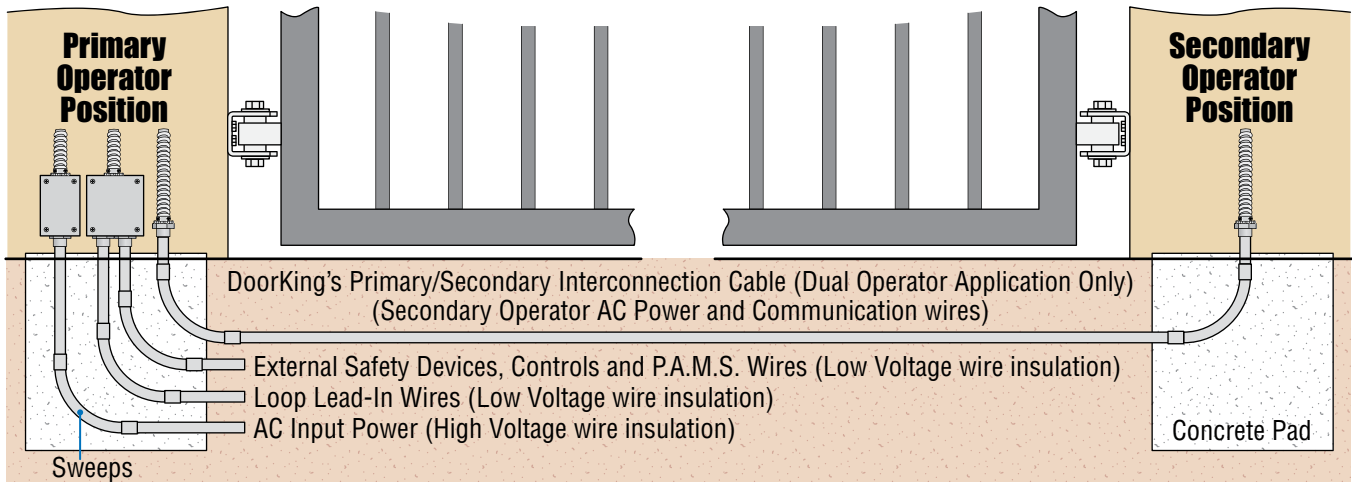

- The conduit requirements are for a typical slide gate operator installation (the secondary operator is shown for those applications where a secondary operator may be used). **The conduit requirements for your application may vary from this depending on your specific needs.**
- Use only sweeps for conduit bends. Do not use 90° elbows as this will make wire pulls very difficult and can cause damage to wire insulation. DoorKing recommends using 3/4-inch conduit.
- Installation of **External Entrapment Protection** is **REQUIRED** (photo sensor and/or reversing edge).
- Be sure that all conduits are installed in accordance with local codes.
- **Never** run low voltage rated wire insulation in the same conduit as high voltage rated wire insulation.

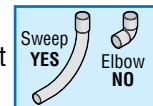

1.4 Pad Mount

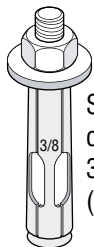

Secure the operator to the concrete pad with four (4) 3/8" x 3" sleeve anchors (not supplied).

Note: 2" thick gate illustrated.

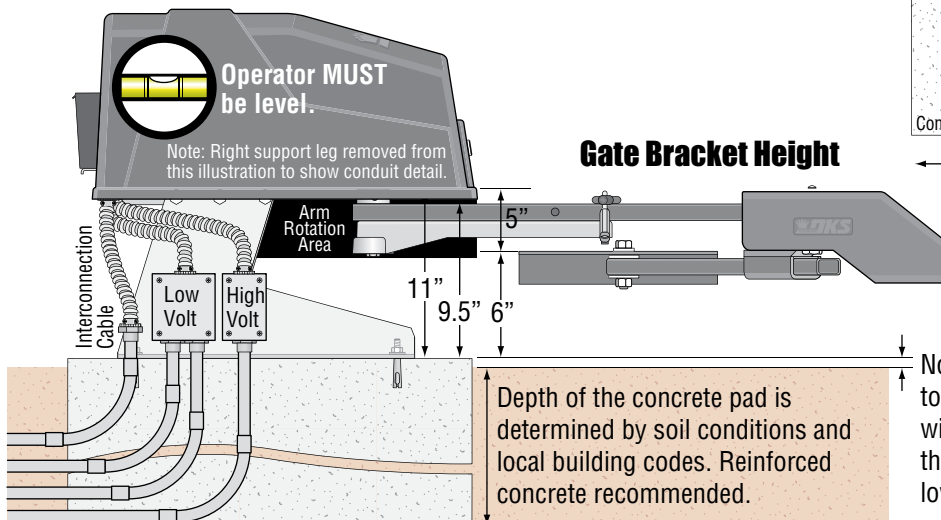
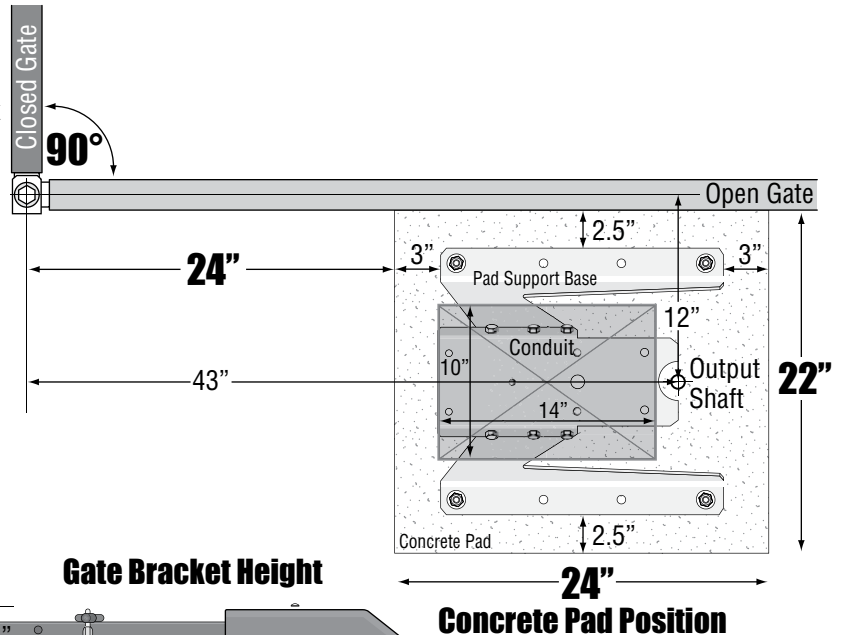

Note: If allowed by local codes, the top of the concrete pad can be flush with ground level, which will allow the gate bracket to be mounted lower on the gate.

1.5 Post Mount

Note: 2" thick gate illustrated.

Mount the post base into the concrete before installing the operator.

The post mount installation will allow the operator to be mounted low enough to attach the gate bracket to the lower gate rail if desired.

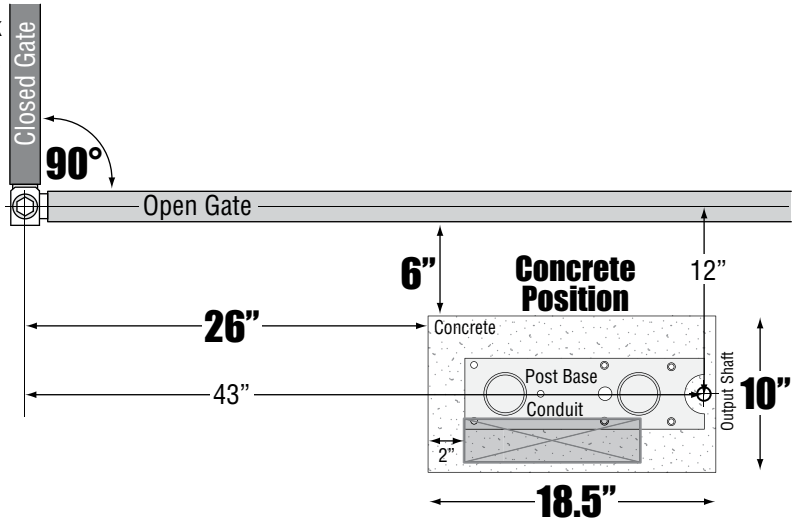

Run all conduit on the opposite side of the open gate.

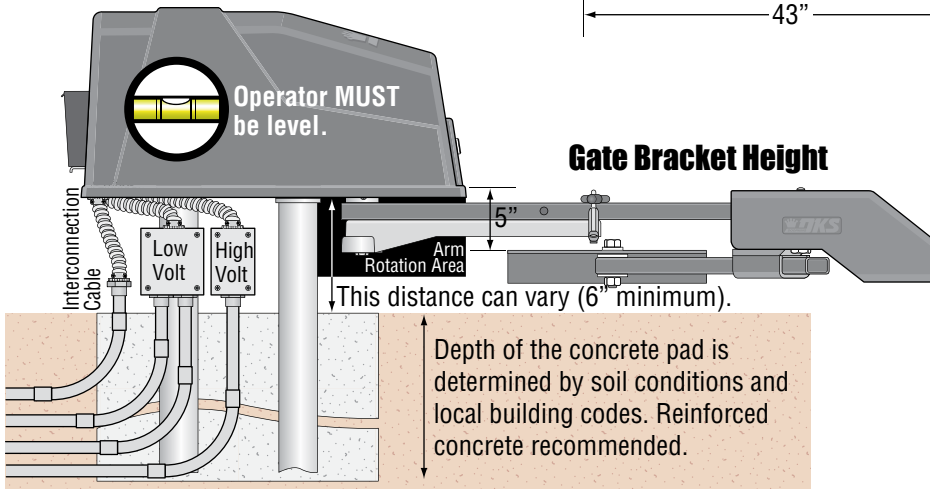

Operator MUST be level.

Gate Bracket Height

This distance can vary (6" minimum).

Depth of the concrete pad is determined by soil conditions and local building codes. Reinforced concrete recommended.

1.6 Arm and Gate Bracket Installation

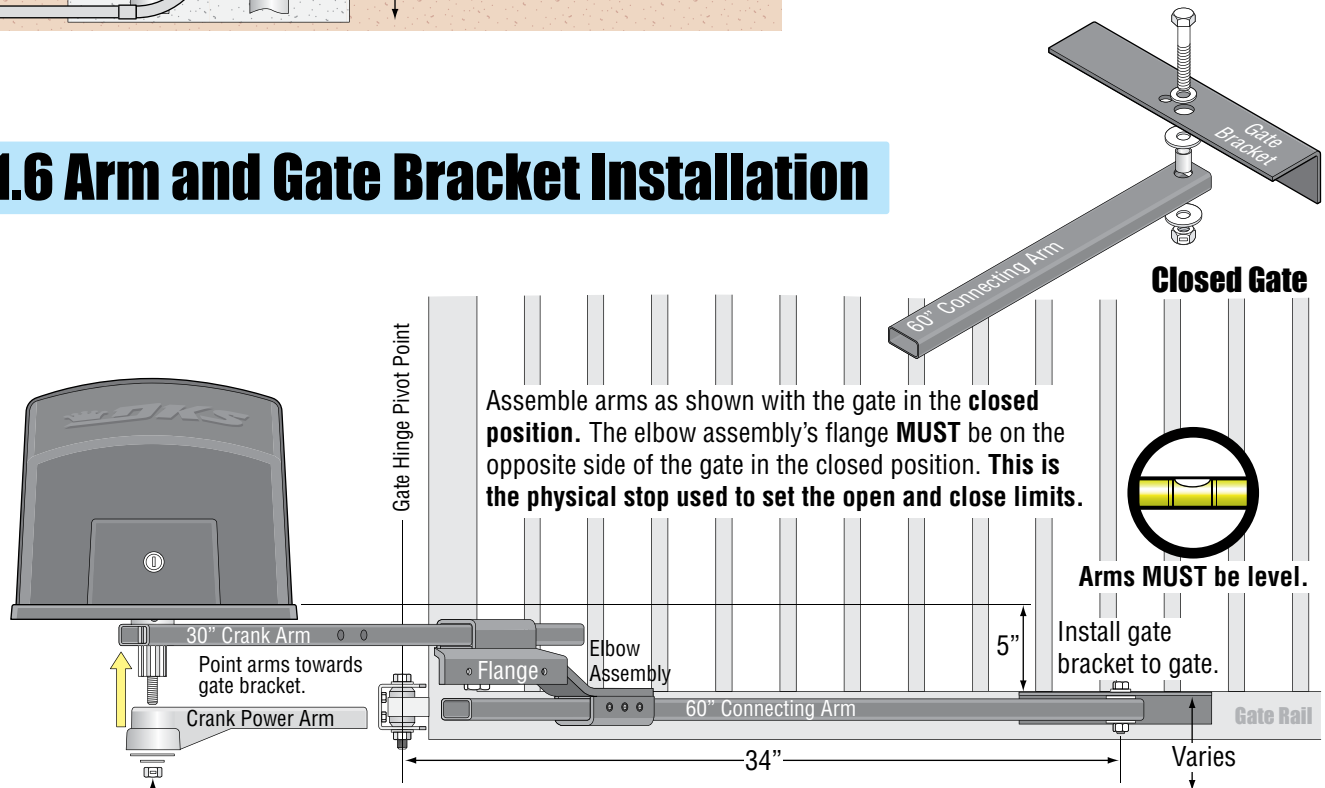

Assemble arms as shown with the gate in the **closed position**. The elbow assembly's flange **MUST** be on the opposite side of the gate in the closed position. **This is the physical stop used to set the open and close limits.**

Arms **MUST** be level.

Install gate bracket to gate.

Adjust the locknut on the crank power arm so that it is snug against the washer, but will still allow the crank arm to rotate with little force. **This is the operator's manual release option when the crank arm is unlocked.**

Do not secure the elbow assembly to the arms until the arms have been adjusted. (See next page).

Do not insert the locking pin or padlock into the crank arm. It will be installed after arms have been adjusted.

1.7 Manually Adjust the Open and Closed Gate Positions

DO NOT power up the operator to set the open and closed gate positions. The first time the operator is powered up and cycled, it will automatically set the open and close limits. To do this, the arms **MUST** already be in the **correct** configuration.

Closed Arms Position

Open Arms Position

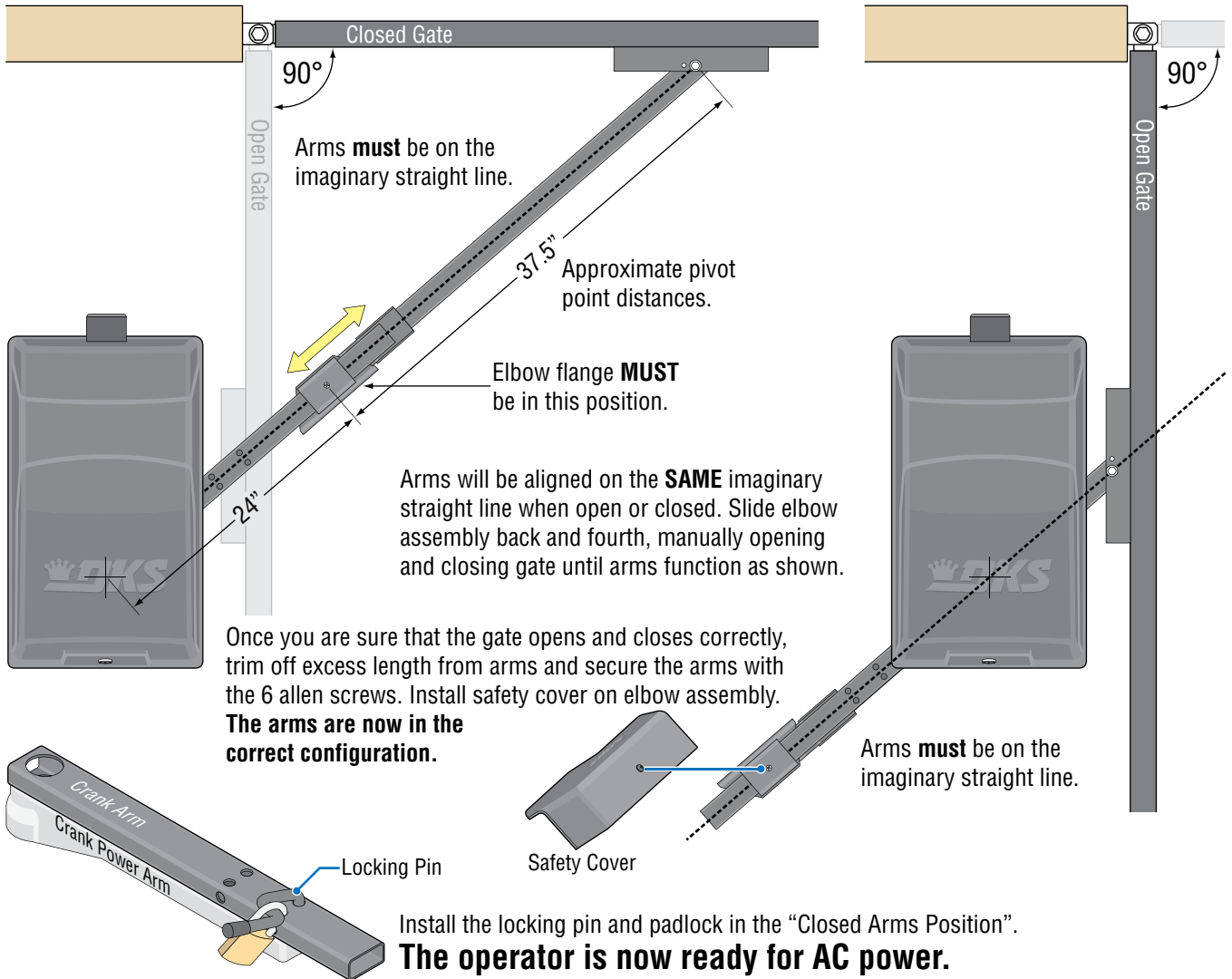

1.8 Installation of Warning Signs

This DoorKing Swing Gate Operator is shipped with two warning signs. The purpose of the warning sign is to alert uninformed persons, and to remind persons familiar with the gate system, that a possible hazard exists so that appropriate action can be taken to avoid the hazard or to reduce exposure to the hazard. See page 3 for suggested mounting positions of signs.

- Permanently install the supplied warning signs in locations so that the signs are visible by persons on both sides of the gate.
- Use appropriate hardware such as wood or sheet metal screws (not supplied) to install the warning signs.



1.9 Entrapment Protection Installation REQUIRED

External Entrapment Protection Devices:

In addition to the inherent reversing sensor system, this operator has a UL 325 terminal for the connection of **photo sensors**-Type B1 and/or **reversing edges**-Type B2 entrapment protection required by UL 325 standards. **Entrapment Protection must be provided for the gate system where the risk of entrapment or obstruction exists. The operator will NOT run without one or more monitored type B1 or B2 external entrapment protection devices installed in each entrapment area.** Install these devices where the risk of entrapment or a safety hazard exists, examples of which are shown below and next page. Installations can vary.

Monitored OPEN Photo Sensor Mounting Position

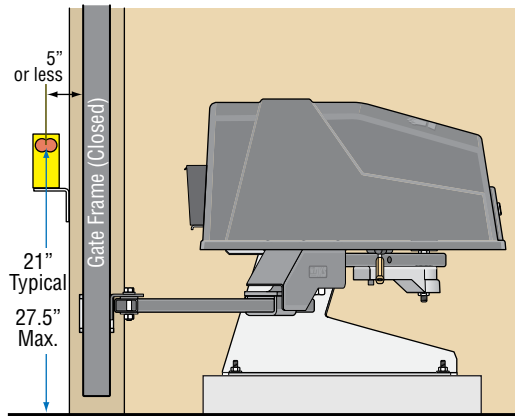

Monitored CLOSE Photo Sensor Mounting Position

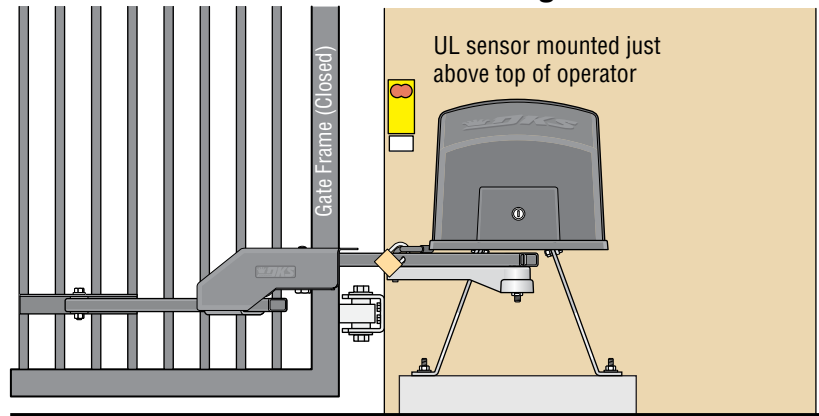

Monitored OPEN Photo Sensor

See page 26 for AUX terminal wiring for monitored photo sensor.

If the distance between an entrapment or obstruction exists less than 16" from the open gate, then entrapment protection is **REQUIRED** for this area.

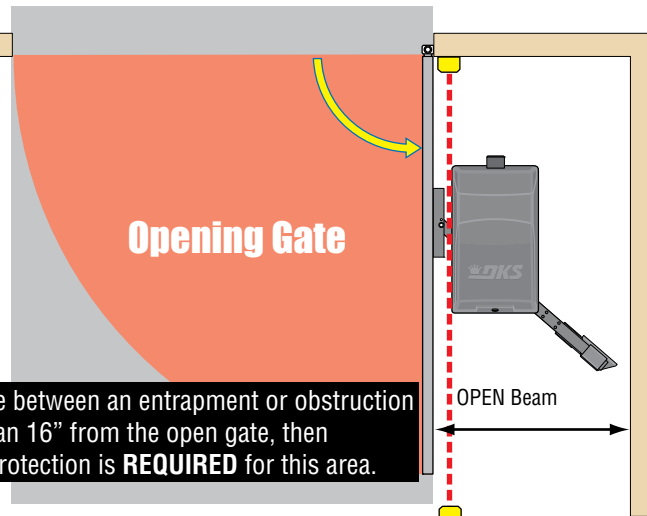

Monitored CLOSE Photo Sensor

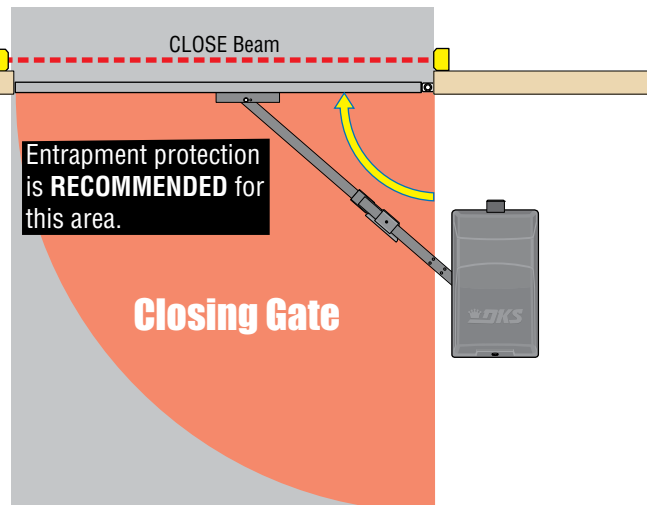

1.9 Continued

A monitored reversing edge (Type B2) or a monitored photo sensor (Type B1, see previous page) **MUST** be installed in **EACH** entrapment area or operator **WILL NOT** function.

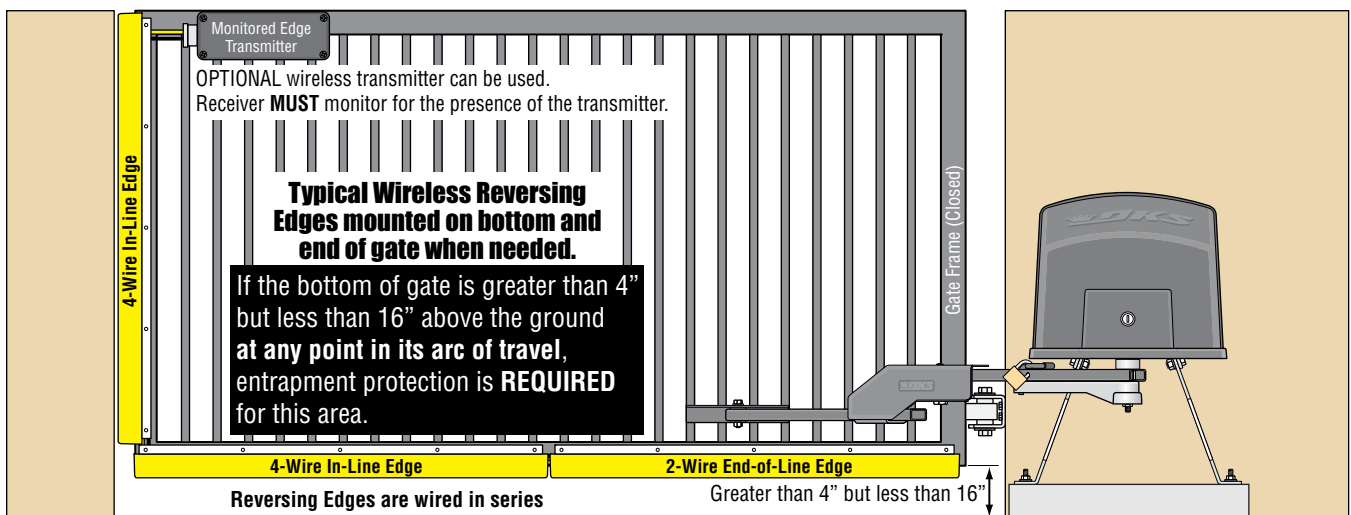
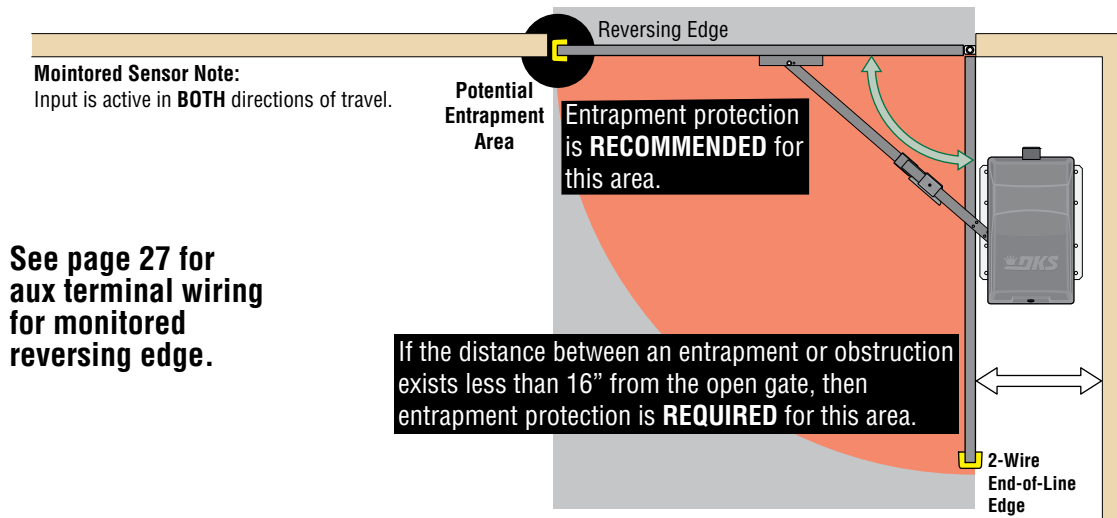
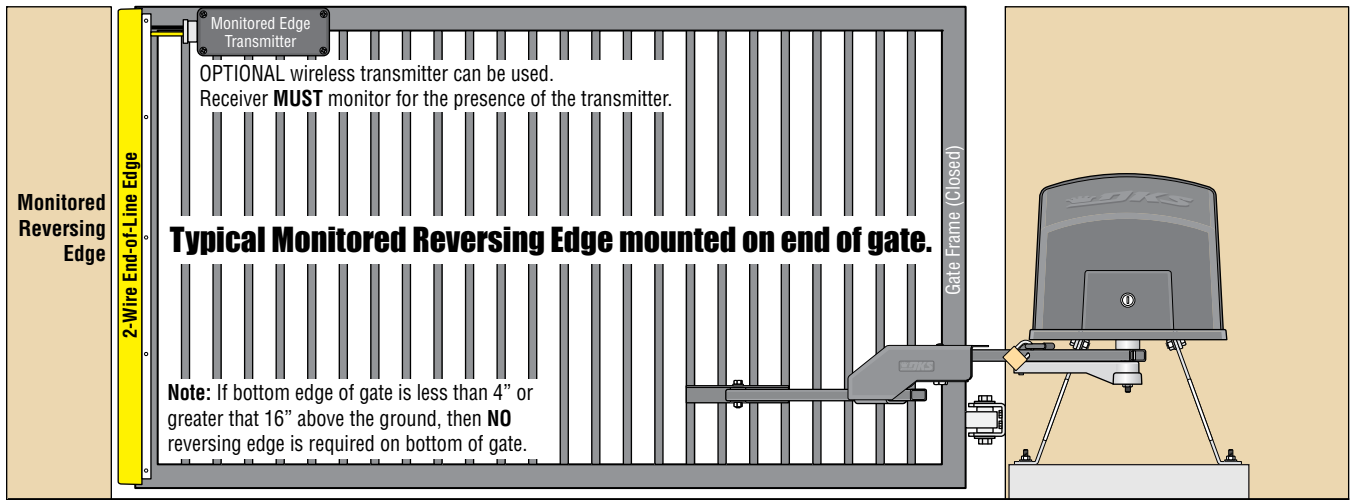

1.10 Gates Opening Wider Than 90°

The installation of an operator opening gates wider than 90° is the same for 1.3 through 1.8 except the operator and concrete pad will be in a different position. Individual requirements can be calculated following this 105° demonstrated sample.

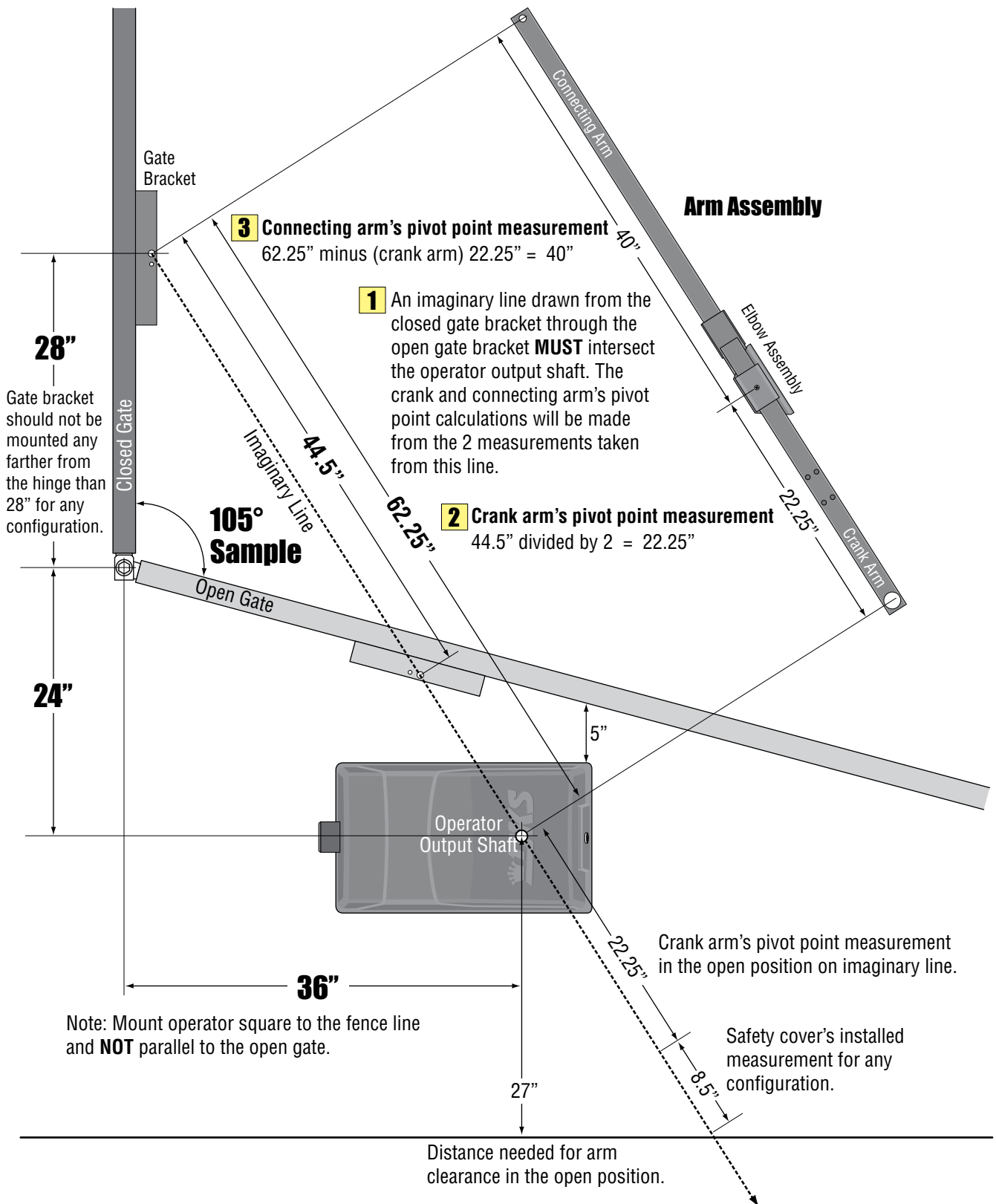

1.11 Overlapping Bi-Parting Gate Operator Positions

When installing overlapping gates (using a maglock to secure gates in the center or architectural overlapping design etc.), certain considerations must be taken into account or gates will **NOT** operate correctly.

The **SECONDARY** operator **OPENS** 1-2 secs **BEFORE** the **primary** operator (SW3, switch 6 - **ON**) to allow the secondary operator's gate to stay clear of the gate overlap. It is **VERY** important to install the **SECONDARY** operator on the gate that opens **FIRST** according to **YOUR** specific gate layout or gates will **NOT** operate correctly.

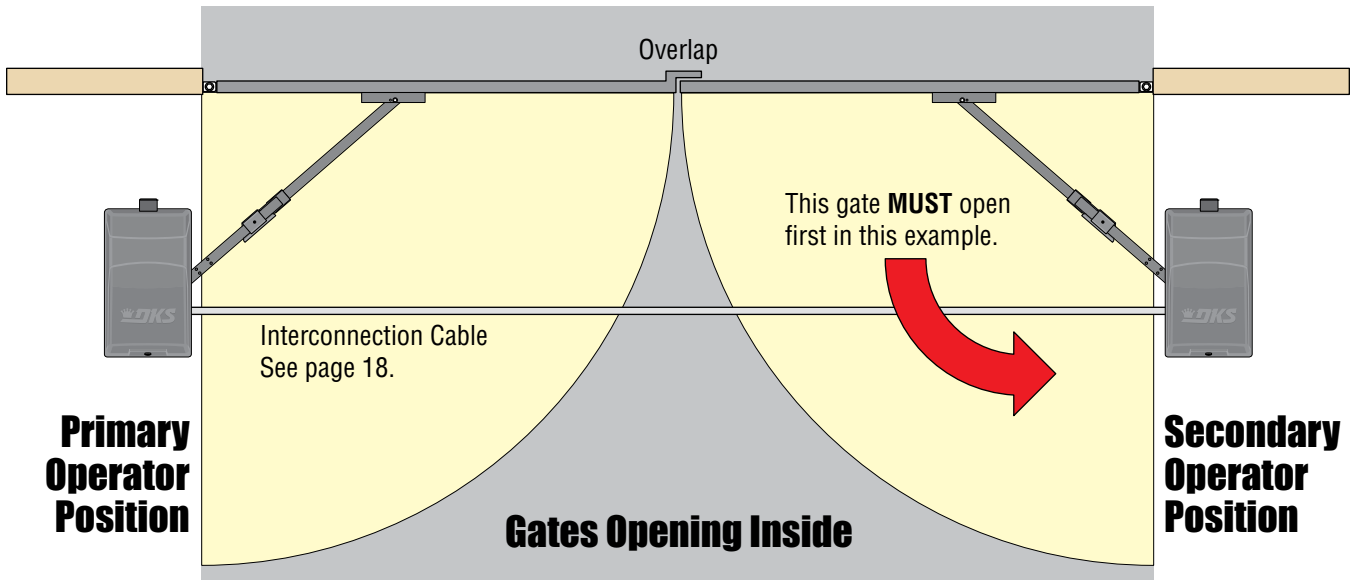

IMPORTANT

All loop detector, safety and access control devices are wired to the **PRIMARY operator**.
AC power is also wired to the **primary operator ONLY**.

IMPORTANT

The **SECONDARY operator** **MUST** be installed on the gate that opens **FIRST**.

IMPORTANT

The distance **EACH** gate travels while cycling **MUST** be the same, otherwise the 1-2 second time delay may **NOT** allow the primary operator's gate **with the overlap** to **CLOSE BEFORE** the secondary operator's gate.

SECTION 2 - AC POWER TO OPERATOR(S)

Before attempting to connect any wiring to the operator, be sure that the circuit breaker in the electrical panel is in the OFF position. Permanent wiring must be installed to the operator as required by local electrical codes. It is recommended that a licensed electrical contractor perform this work.

Since building codes vary from city to city, we highly recommend that you check with your local building department prior to installing any permanent wiring to be sure that all wiring to the operator (both high and low voltage) complies with local code requirements.

THIS GATE OPERATOR MUST BE PROPERLY GROUNDED!!

2.1 High Voltage Wire Runs

The distance shown in the chart is measured in **Feet** from the operator to the power source. If power wiring is greater than the maximum distance shown, it is recommended that a service feeder be installed. When large gauge wire is used, a separate junction box must be installed for the operator connection. The wire table is based on stranded copper wire. The wire run calculations are based on a power source with a 3% voltage drop on the power line, plus an additional 10% reduction in distance to allow for other losses in the system.

This table illustrates the high voltage AC power wire size and distance limitations.

Model Type	Amps Required	Wire Size / Max Distance in Feet			
		12 AWG	10 AWG	8 AWG	6 AWG
6050 Single	4.3	225	365	610	915
6050 Dual	8.6	112	182	305	457
6100 Single	5.4	180	290	485	725
6100 Dual	10.8	90	145	242	362

Never run low voltage rated wire insulation in the same conduit as high voltage rated wire insulation.

“Optional” 3.3 Amp Heater Installation Note: When installing the heater(s), refer to the “high voltage AC power wire size and distance requirements” table on the instruction sheet with the heater kit (P/N 1601-154) for AC power wire run requirements.

2.2 High Voltage Terminal Connection

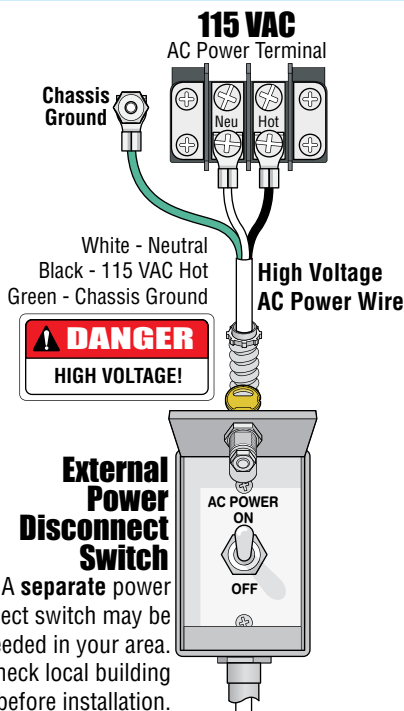

- Route incoming high voltage power through underground conduit and into the operator as shown in Section 1.4 or 1.5 on page 10 or 11.
- Be sure wiring is installed in accordance with local codes. Be sure to color code all wiring.
- It is recommended that a surge suppressor be installed on the high voltage power lines to help protect the operator and circuit board from surges and power fluctuations.
- Secondary operator in a dual operator application gets power through the 8-wire interconnection cable that links the 2 operators together. See Section 2.3 Bi-Parting Gates Wiring - Dual Gate operators on the next page.

⚠ Section 1 MUST be completed before power can be turned on.

⚠ Every time the operator is powered up, the First open command will automatically set the open and close limits of the gate. (See page 22).

EXTERNAL ENTRAPMENT PROTECTION MUST be installed or the gate operator WILL NOT function. (see pages 13, 14 and 26)

2.3 Bi-Parting Gates Wiring - Dual Gate Operators

Connect the Primary/Secondary operators together with DoorKing's interconnection cable as shown (Different lengths sold separately P/N 2600-75x). High voltage power and low voltage communications are supplied to the secondary operator by DoorKing's UL approved cable that is run in a single conduit. Two conduits (High voltage and low voltage) will need to be provided to the secondary operator when NOT using DoorKing's UL listed, wet environment interconnection cable.

Interconnection Cable Wiring	
Secondary Operator	Primary Operator
(Red) Motor #1	Motor Terminal #1 (Red)
(Blue) Motor #2	Motor Terminal #2 (Blue)
(White) Neutral #3	Main Terminal Neutral #2 (White)
(Purple) 24 VAC #4	Main Terminal 24 VAC #7 (Purple)
(Yellow) 12 VAC #5	Main Terminal 12 VAC #8 (Yellow)
(Brown) Pulse 2 #6	Main Terminal Pulse 2 #10 (Brown)
(Orange) COM #7	Main Terminal COM #19 (Orange)

- All control, loop detector, safety and auxiliary devices are wired to the primary operator.
- Secondary operator contains NO 4502 control board.

Secondary Operator Terminal

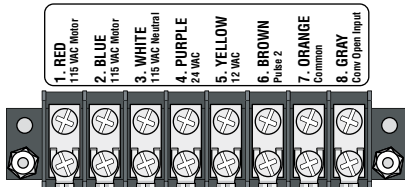

SW 4, Switch 7 **MUST** be OFF.



SW 3, Switches 1&2 are set opposite each other.
SW 3, Switch 4 **MUST** be ON.
SW 3, Switch 6 is ON if using Overlapping Gates.

Secondary operator open first. See page 16.

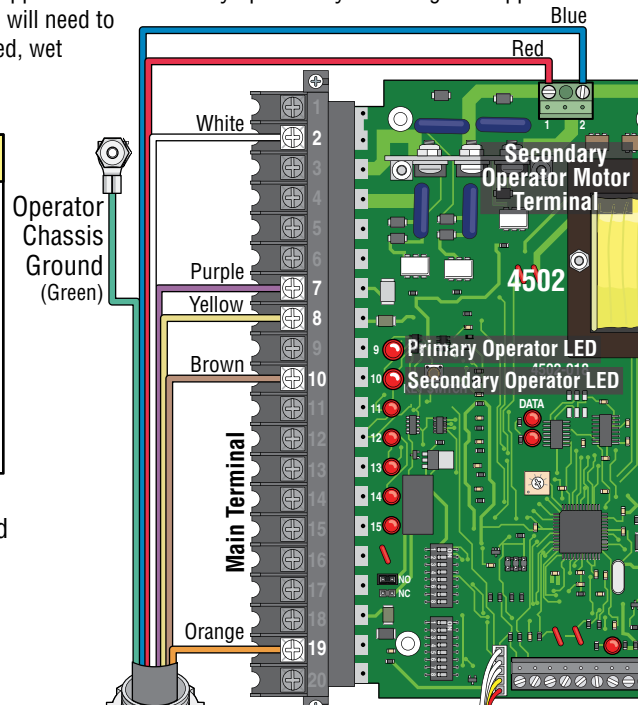

Primary Operator Control Board

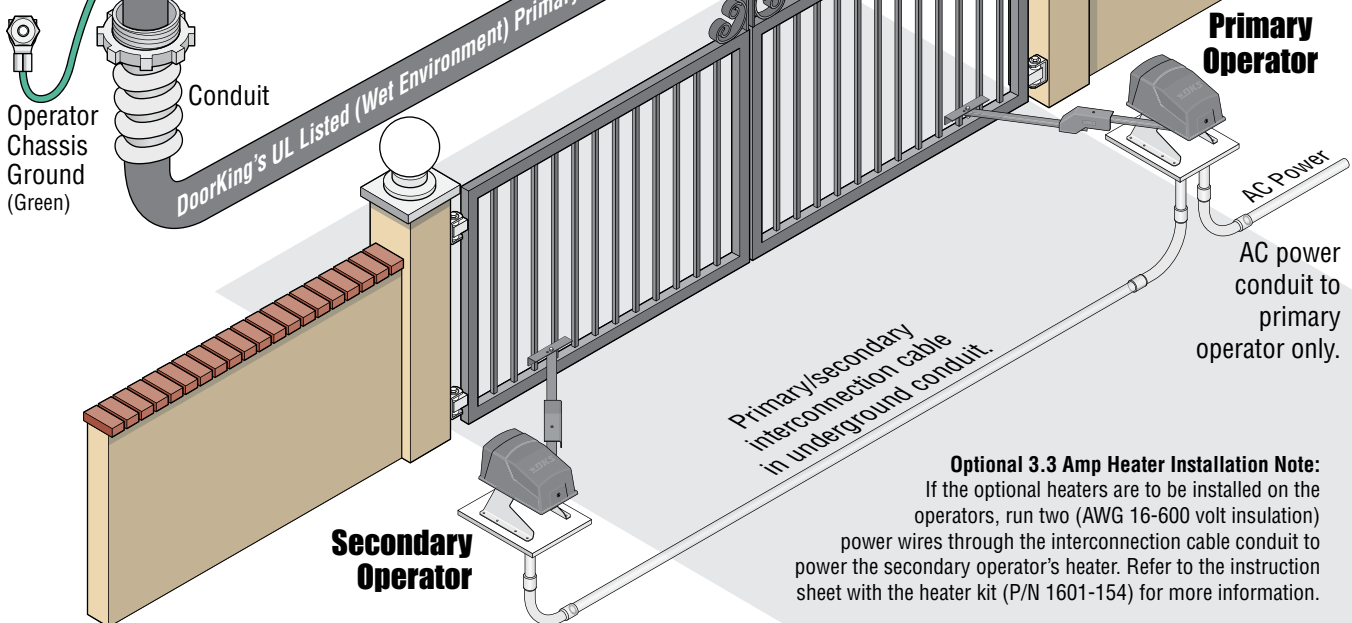

Primary/secondary interconnection cable in underground conduit.

Optional 3.3 Amp Heater Installation Note:

If the optional heaters are to be installed on the operators, run two (AWG 16-600 volt insulation) power wires through the interconnection cable conduit to power the secondary operator's heater. Refer to the instruction sheet with the heater kit (P/N 1601-154) for more information.

SECTION 3 - ADJUSTMENTS

The switch settings and adjustments in this chapter should be made after your installation and wiring to the operator(s) is complete. **Whenever any of the programming switches on the circuit board are changed, power must be shut-off, and then turned back on for the new setting to take effect.**

3.1 4502 Circuit Board Description and Adjustments

How LEDs Work: **Power LED** indicates that low voltage power is applied to the circuit board. **Input LEDs** should be OFF and will only illuminate when an input is activated. **Pulse 1 and 2 LEDs** will blink as the operator(s) are running. They can be either ON or OFF when the operator(s) are stopped. One pulse LED for each operator used (Primary/Secondary). **Loop LEDs** will flash when each specific loop is activated.

Tracker LEDs will flash as operator data is sent to the access controller (DoorKing models 1833, 1835, 1837 or 1838 only).

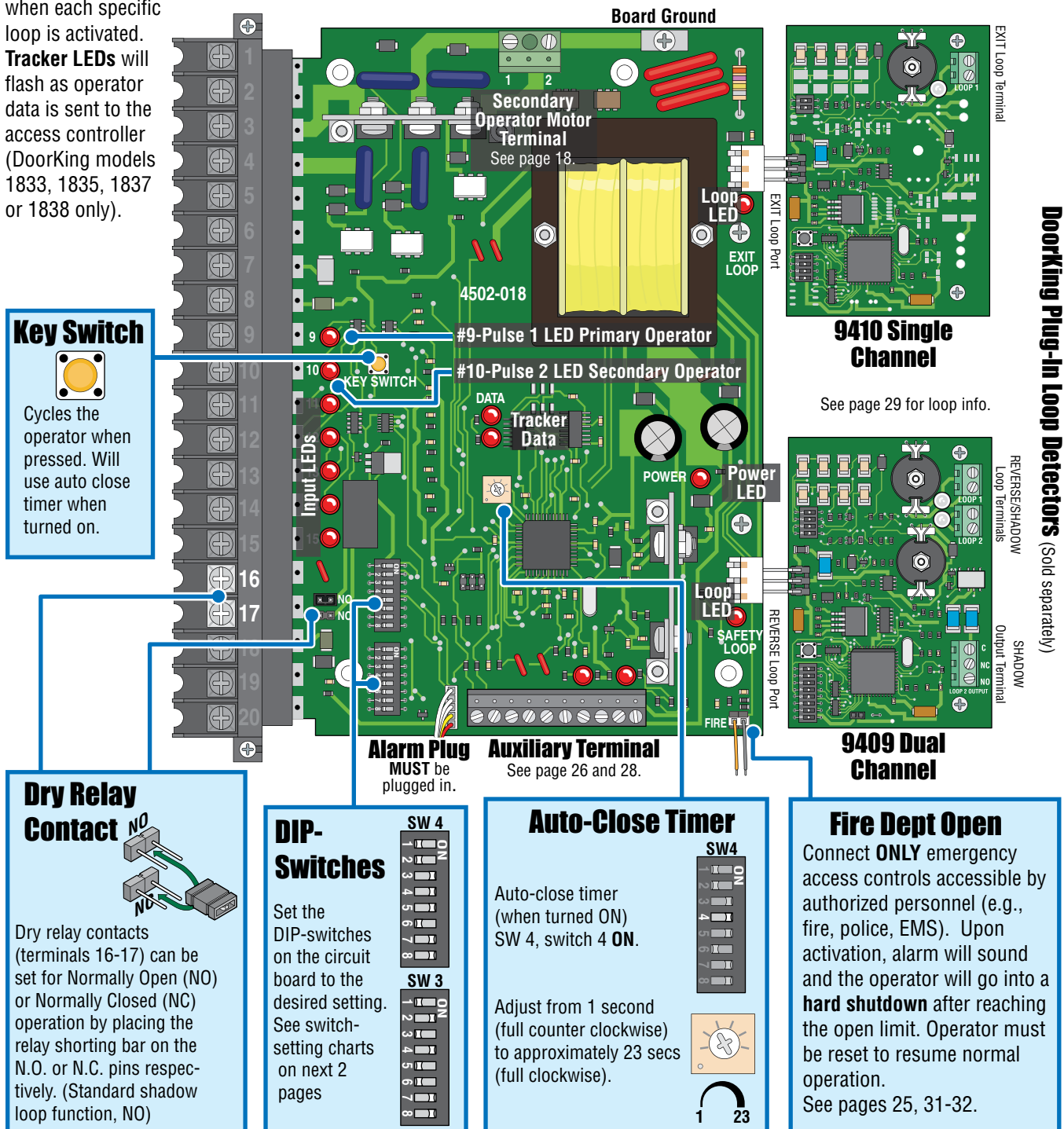



DoorKing Plug-In Loop Detectors (Sold separately)

See page 29 for loop info.

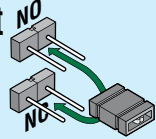
Key Switch

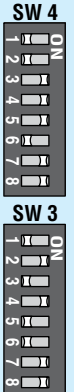
 Cycles the operator when pressed. Will use auto close timer when turned on.

Dry Relay Contact

 Dry relay contacts (terminals 16-17) can be set for Normally Open (NO) or Normally Closed (NC) operation by placing the relay shorting bar on the N.O. or N.C. pins respectively. (Standard shadow loop function, NO)

DIP-Switches

 Set the DIP-switches on the circuit board to the desired setting. See switch-setting charts on next 2 pages

Auto-Close Timer

 Auto-close timer (when turned ON) SW 4, switch 4 ON.
 Adjust from 1 second (full counter clockwise) to approximately 23 secs (full clockwise).

Fire Dept Open
 Connect **ONLY** emergency access controls accessible by authorized personnel (e.g., fire, police, EMS). Upon activation, alarm will sound and the operator will go into a **hard shutdown** after reaching the open limit. Operator must be reset to resume normal operation.
 See pages 25, 31-32.

3.2 DIP-Switch SW 3 & SW 4 Settings

The two DIP-switches located on the circuit board are used to program the operator to operate in various modes and to turn on or off various operating features. Whenever a switch setting is changed, power to the operator must be turned OFF and then turned back on for the new setting to take affect. Check and review ALL switch settings prior to applying power to the operator.

⚠ Every time the operator is powered up, the First open command will automatically set the open and close limits of the gate. (See page 22).

SW 4 (Top 8 Switches)			
Switch	Function	Setting	Description
1 and 2	Circuit Board Relay	1-OFF 2-OFF	Relay activates when gate is open (Shadow loop setting when used).
		1-OFF 2-ON	Relay activates when gate is not closed.
		1-ON 2-OFF	Relay activates when gate is opening and open.
		1-ON 2-ON	Relay activates when gate is opening and closing.
3	Exit Loop Port Output	OFF	The output wired to terminal #12 becomes the output from the exit loop detector plugged into the EXIT Loop port.
	Full Open Input	ON	Normal Setting. Terminal #12 is a normal full open input.
4	Auto-Close Timer	OFF	Auto-close timer is OFF. Manual input required to close gate.
		ON	Auto-close timer is ON. Adjustable from 1-23 seconds to close gate.
5	Slide Operator	OFF	Switch must be OFF for slide gate operator (DO NOT use for 6050/6100).
	Swing Operator	ON	Normal Setting. Switch must be ON for swing gate operator.
6	3-Button	OFF	OFF when using a 3-button station (DoorKing 3-button control stations only).
	Single Button	ON	ON when using a single button control, terminals 13 & 14 become a STOP input.
7	Dual Operators	OFF	Switch must be OFF when bi-parting (dual) gates are used.
	Single Operator	ON	Switch must be ON for single operator.
8	Tamper Protect	OFF	Tamper protect is OFF.
		ON	Normal Setting. Tamper protect is ON. Operator will close gate when being forced open.

SW 3 (Bottom 8 Switches)			
Switch	Function	Setting	Description
1	Primary Gate Opening Direction		<div style="display: flex; justify-content: space-around; align-items: center;"> <div style="text-align: center;"> <p>Opens Clockwise</p> <p>ON</p> </div> <div style="text-align: center;"> <p>Opens Counter-Clockwise</p> <p>OFF</p> </div> </div>
2	Secondary Gate Opening Direction		Same as above, for secondary 6050/6100 ONLY .
3	Self-Test	OFF	Normal Setting. Normal operation.
		ON	Self-test mode. Operator MUST be disconnected from gate to run self test.
4	Single Gates OR Bi-Parting Gates	OFF	Switch is OFF when using a single operator.
		ON	Switch is ON when using dual gate operators (Primary/Secondary Bi-Parting gates).
5	Reverse	OFF	Terminal 15 is a STANDARD Reverse input.
	Shadow Loop	ON	Terminal 15 is a Shadow input. Gate will NOT stop during the close cycle.
6	Gate Overlap	OFF	Primary and secondary operators start at the same time.
		ON	Secondary operator starts 1-2 seconds prior to primary operator.
7	Monitored Close Beam	OFF	No Photo Sensor connected to Aux terminal 7 and 8.
		ON	Photo sensor is connected to Aux terminal 7 and 8 and monitored. (Close ONLY)
8	Monitored Edge/Beam	OFF	No Edge or Beam connected to Aux terminal 9 and 10.
		ON	Edge OR Beam is connected to Aux terminal 9 and 10 and monitored. (Open/Close)

3.3 DIP-Switch Definitions

SW 4 (Top 8 Switches)

Switches 1-2 These work in conjunction with each other and determine when the relay on the board will be activated. This relay can be used as a switch for various functions such as illuminating a warning light when the gate is moving, or turning on a green light when the gate is full open. This relay is **NOT** available for these uses if it is being used for the SHADOW loop function.

Switch 3 Determines that a device wired to terminal #12 is a normal full open command **OR** terminal #12 becomes the output from the exit detector that is plugged into the EXIT Loop port in the circuit board (Used for specialized functions).

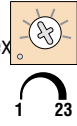

Switch 4 Turns the auto close timer on or off. Maximum time that the close timer adjustment can be set for is approximately 23 seconds.

Switch 5 Turn this switch **ON** for the 6050/6100. **ONLY** turn this switch OFF when using this circuit board in older slide gate operator models.

Switch 6 Sets up the circuit board for single button (ON setting) **OR** a DoorKing 3-button control station only (OFF setting). When this switch is ON, terminals 13 and 14 can be used as a Normally Open **STOP** input for single button control. When this switch is OFF, terminals 13 and 14 can be used with a DoorKing 3-Button control station **ONLY** for Open, Close and Stop input.

Switch 7 Sets up the circuit board for single or primary / secondary (dual) gate operation.

Switch 8 If the gate is forced open, the tamper-protect system will start the motor in the close direction when the operator senses the forced open condition.

SW 3 (Bottom 8 Switches)

Switch 1 **Must OPEN** the **primary** operator's gate upon initial AC power up and open command. If the **FIRST** open command begins to close the gate, turn AC power off and reverse this switch.

Switch 2 **Must OPEN** the **secondary** operator's gate upon initial AC power up and open command. If the **FIRST** open command begins to close the gate, turn AC power off and reverse this switch. This switch will be set the opposite of switch 1 (e.g. If switch 1 is OFF, then switch 2 will be ON).

Switch 3 This switch is a self-test feature that checks various functions of the circuit board and is used for bench test only. **Do not run this test with the operator connected to the gate.**

Switch 4 This switch applies high voltage motor power to the secondary operator motor terminal located at the top of the board (See page 18). If a primary / secondary system is in use, this switch should be **ON** and the secondary motor wires connected to the secondary operator motor terminal. For single gate applications, this switch can be turned **OFF**.

Switch 5 This switch sets the input at Terminal 15 to act as a normal reverse input **OR** to act as a shadow input. A shadow input will only hold the gate operator in the open position once it is in the full open position. A shadow input **will not** reverse the direction of the gate operator once it begins its close cycle.

Switch 6 Used in primary / secondary applications, turning this switch ON will cause the secondary operator to start 1-2 seconds before the primary operator. This allows the secondary gate to reach the full closed position before the primary gate, which is desirable when the gates are constructed with an overlap (see page 16) or if a magnetic lock is used to secure the gates.

Switch 7 Turn this switch ON when a **MONITORED Photo Sensor** is wired to aux terminals #7 - #8. Photo sensor is active in **CLOSE** direction of gate travel and will **reverse gate to FULL Open position**.

Switch 8 Turn this switch ON when a **MONITORED Reversing Edge OR Photo Sensor** is wired to aux terminals #9 - #10. Sensor is active in **BOTH** directions of gate travel and will **reverse gate to FULL Open or FULL Closed position**.

Monitored Sensor LEDs

LED ON: Connected device has been activated. LED remains off during normal operation.

One LED Flashing: Connected device is in fault. Wiring to device is bad.

Both LEDs Flashing: Both connected devices are in fault.

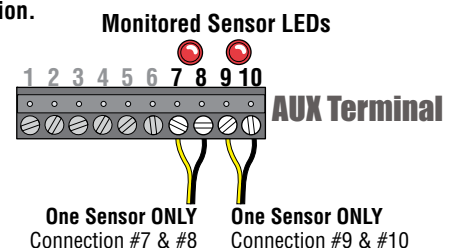

3.4 Automatic Open / Close Limit Adjustment

The 6050/6100's open/close limits **DO NOT** have to be physically adjusted. The gate open and close positions are determined by the physical stop "Flange" on the elbow assembly (See below). The arms **MUST** already be in the **correct** closed configuration (See Section 1.7 on page 11). **DO NOT cycle the operator until the arms are in the correct configuration. Every time the operator is powered up, the first open command will automatically run an open and close cycle to locate and remember the gate's open and close positions.**

Timer: The Auto-Close Timer should be turned ON (SW 4, switch 4 **ON**) to allow the operator to run the automatic gate sequence, otherwise a manual close command will be required to complete this sequence.

Clutch: The clutch's factory setting will work correctly for most installations. The clutch must **NOT** slip while the gate is in mid-cycle or the gate limits will be incorrect. If the clutch slips during this period, it must be tightened before running this sequence (See section 3.5 on the next page).

Safety Devices: Run this sequence **before** testing any safety features (inherent reverse sensor, external safety devices, entrapment alarm and reset features).

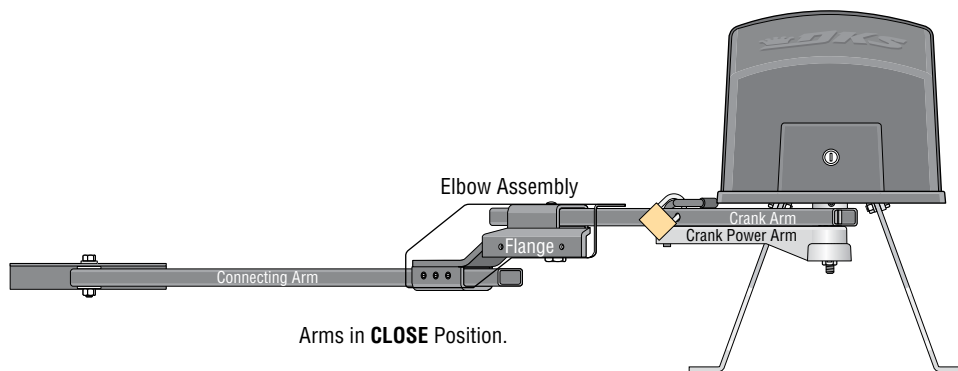

Sequence of Automatic "Gate Cycle" to Set Gate Limits

⚠ CAUTION: Keep pedestrians and vehicles clear of the gate while this sequence is running!

After the first open command is given to the operator (gate can be in any position):

Open

Gate **MUST** open until it contacts the **physical stop "Flange"**. (if gate starts to close, turn power off and change the direction operator opens (SW 3, switch 1). Turn power back on and give open command again). After the gate cycles to the full **OPEN** position, the clutch will slip for approximately 2 seconds and shut off.

Close

Auto-close timer will close the gate until it contacts the **physical stop "Flange"**. (Manual close command required if timer is turned off). When the gate cycles to the full **CLOSE** position, the clutch will slip for approximately 2 seconds and shut off.

Sequence Finished

Open and close gate positions are now set and will be remembered by the 6050/6100 (until it loses AC power). **Gate will function normally** after automatic sequence has finished.

Cycle the operator again. Operator will reach the open and close positions and shut off **without the clutch slipping**.

Note: If gate encounters an obstruction during this sequencing, it will automatically continue after obstruction has been cleared.

3.5 Clutch Adjustment

This vehicular gate operator is equipped with an inherent adjustable clutch.

The clutch **MUST** slip upon sensing an obstruction during the open or close cycle which will cause the gate to reverse direction. For this system to function correctly, the gate must be properly installed and work freely in both directions. A good set of roller bearing hinges is essential for proper swing gate operation.

1. Be sure **AC power switch is turned OFF** whenever adjustments to the clutch are being made. Loosen the upper jamb nut to “un-lock” the lower jamb nut. Loosen the lower jamb nut.
 2. Manually move the gate so that it is positioned approximately half way open.
 3. Tighten the lower jamb nut finger tight then tighten it **ONE** turn with a wrench. Re-tighten the upper jamb nut.
 4. Turn AC power switch **ON** and press the **KEY SWITCH** on the circuit board. When the gate begins to open, determine if the clutch is slipping. If the clutch is slipping, turn AC power OFF and tighten the lower jamb nut **one more turn**. This process may have to be repeated several times to get the clutch adjusted correctly.
- Always start the gate from the half open position when adjusting the clutch.**

Clutch Note: The ideal clutch adjustment will allow the operator to move the gate through its open and close travel cycle **without** slipping, but **will** slip upon contact with an obstruction with **no more than 40 Lbs of force**. This force can be measured with a gate scale.

CAUTION: Keep pedestrians and vehicles clear of the gate while adjusting and testing the clutch!

Test the Clutch:

Obstruct the gate while it is in the OPENING cycle. The clutch **MUST** slip with no more than 40 Lbs of force, then the gate will reverse direction for a quarter of a second and **STOP**. If the clutch does not slip, it is too tight. Repeat step 4 and re-adjust the clutch.

Note: After the gate has reversed and **STOPPED**, the operator will be in a “Soft Shutdown”. Press the **KEY SWITCH** on the circuit board to continue the opening cycle after the obstruction has been cleared.

Obstruct the gate while it is in the CLOSING cycle.

The clutch **MUST** slip with no more than 40 Lbs of force, then the gate will **REVERSE** direction back to the open position. If the clutch does not slip, it is too tight. Repeat step 4 and re-adjust the clutch.

Note: After the gate has **reversed** back to the open position, the operator will be in a “Soft Shutdown”.

Press the **KEY SWITCH** on the circuit board to start the closing cycle again after the obstruction has been cleared.

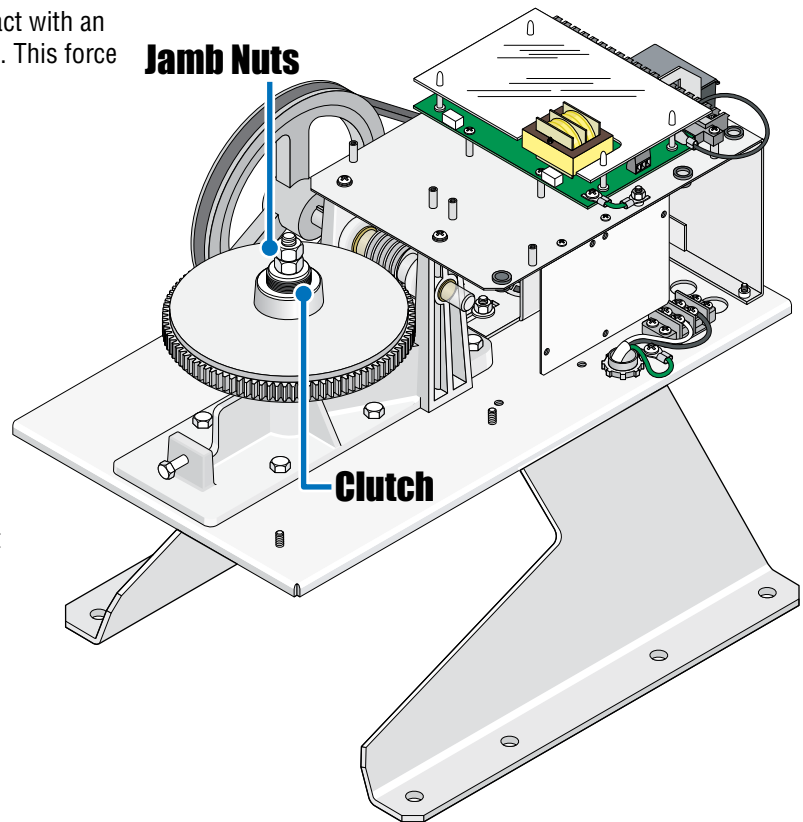

3.6 Inherent Entrapment Protection System

In addition to the mechanical slip clutch, this operator uses an inherent entrapment protection system (Type A) to further reduce the possibility of injury should an entrapment occur. This entrapment protection system (Revering sensor) is **completely automatic** and will be activated **if the clutch fails to slip when an obstruction is sensed** during the open or close cycle. This feature requires **no adjustment** by the installer or end user.

SECTION 4 - WIRING

4.1 Main Terminal Description

- When gate is closed, input will open gate.
- When gate is open and auto close timer SW 4, switch 4 is turned **ON**, input will re-set and hold timer.
- When gate is open and auto close timer SW 4, switch 4 is turned **OFF**, input will close gate.
- When gate is closing, input will **reverse** gate.



- If SW 4, **switch 3** is **ON**, functions as a normal full open input (Normal setting).
- If SW 4, **switch 3** is **OFF**, input to terminal #12 becomes the output from the EXIT loop detector plugged into the EXIT loop port. (Used for specialized functions).



This input **ONLY** functions when gate is **fully opened** or in the **closing cycle**.

- When gate is closing: SW 3, **switch 5** is **OFF**, an input to terminal #15 will **reverse** and open the gate.
Note: If the auto-close timer is **ON**, when gate reaches the open position, timer will then time out and close the gate.
- When gate is closing: SW 3, **switch 5** is **ON**, an input to terminal #15 has **NO** effect on the gate operator (Set for **Shadow** input).



Operation of the circuit board dry relay contact is dependent on setting of SW 4, **switches 1 and 2**. **Relay contacts** can be set for Normally Open (NO) or Normally Closed (NC) operation. Contact rating is 1 amp maximum at 24-volts DC.

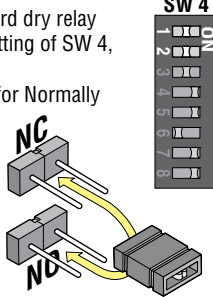

24-volt DC magnetic lock power is provided constantly except when the gate is **opening** or **open** (Normally Closed function).

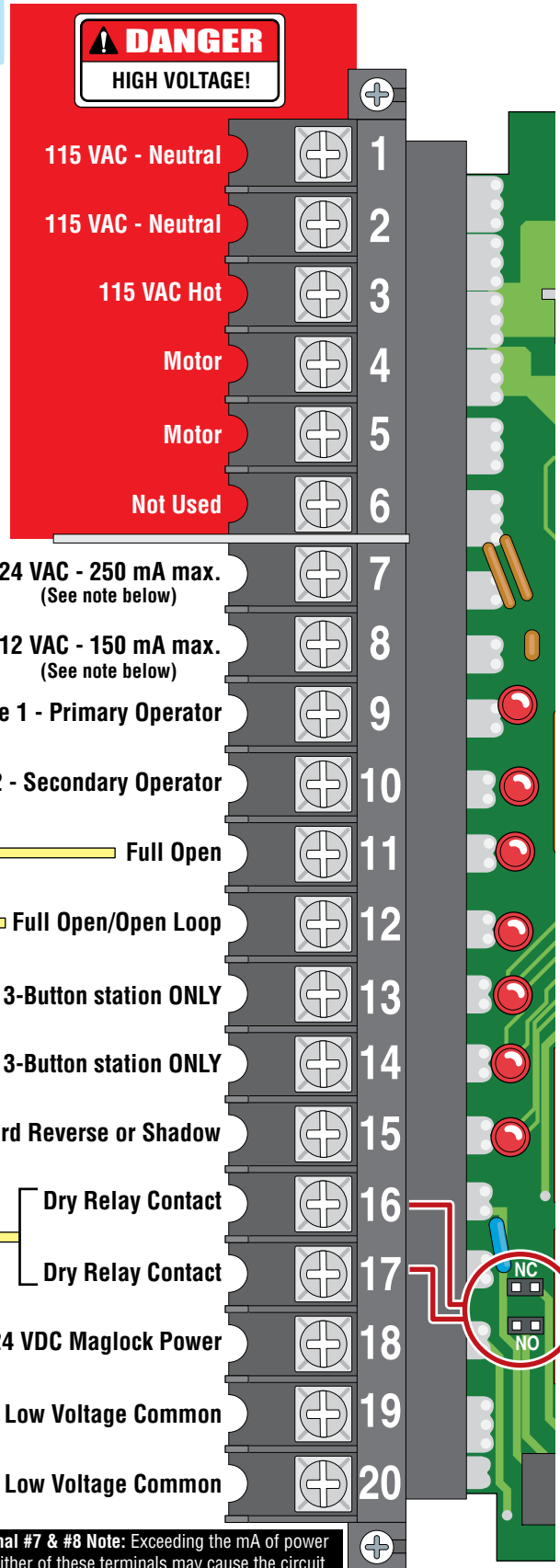

Terminal #7 & #8 Note: Exceeding the mA of power from either of these terminals may cause the circuit board transformer to overheat, causing intermittent problems. Use this to power the radio receiver **ONLY**.

4.2 Control Wiring

Type of wiring to be used on ALL external devices:
A) Type CL2, CL2P, CL2R, or CL2X.
B) Other cable with equivalent or better electrical, mechanical, and flammability ratings.

#11 - Access Control Devices

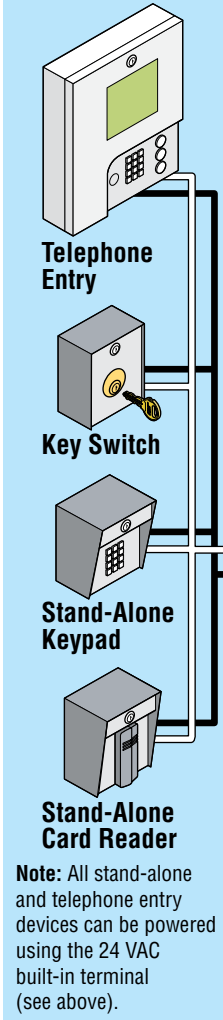

Note: All stand-alone and telephone entry devices can be powered using the 24 VAC built-in terminal (see above).

Important: Controls intended for user activation must be located at least six (6) feet away from any moving part of the gate and where the user is prevented from reaching over, under, around or through the gate to operate the controls. Emergency access controls only accessible by authorized personnel (e.g., fire, police, EMS) may be placed at any location in the line-of-sight of the gate.

Powering Entrapment Protection Devices

24 VAC Power Output
 Powers 24VAC control devices/ entrapment protection devices.
 (2 amps Max)

3-Wire Radio Receiver
 Limited to 250 mA

Antenna mounted outside operator cover.

Coax Antenna Kit
 P/N 1514-073

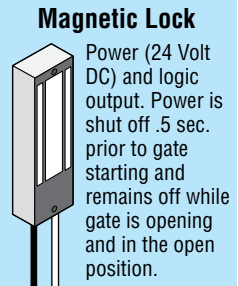
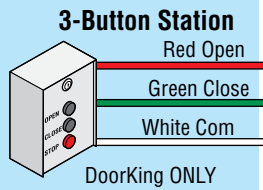

24 VDC @ 250 ma Max.

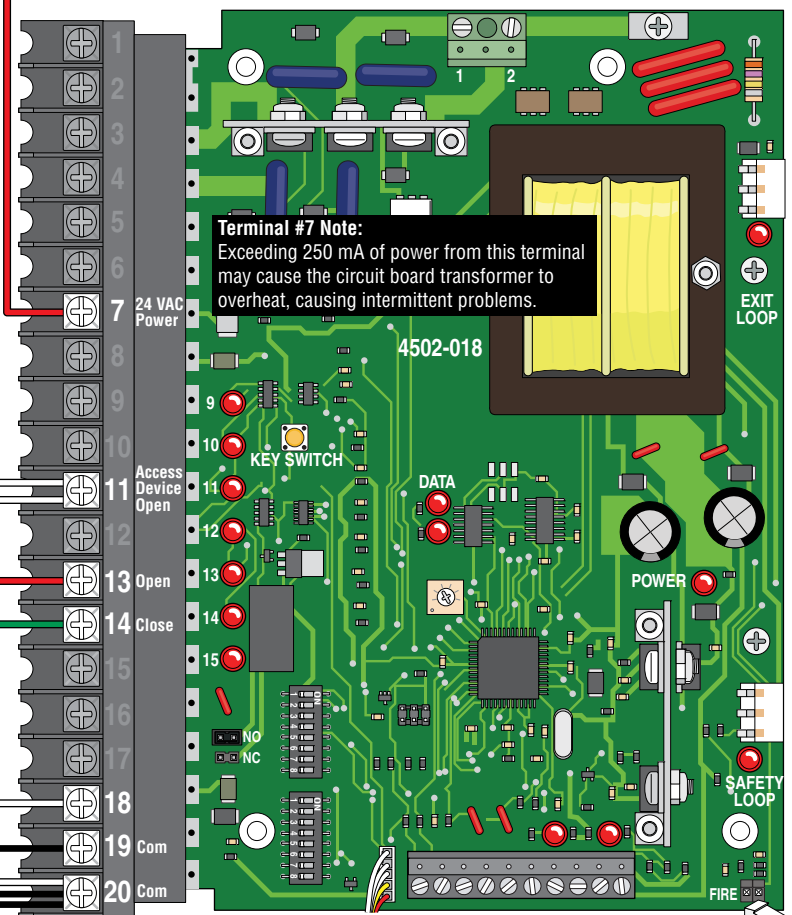

Terminal #7 Note:
 Exceeding 250 mA of power from this terminal may cause the circuit board transformer to overheat, causing intermittent problems.

Fire Dept Open

Gate will **ONLY OPEN** when this device is activated by authorized personnel **ONLY** (fire, police, EMS) and operator has power. Alarm will sound during entire open cycle. Operator will then go into a hard shutdown once fully opened. Operator **MUST** be reset to function normally again. This device **MUST** be mounted in the line-of-site of gate so authorized personnel can monitor gate movement.

Activation Note: Activation of this device will **OPEN** gate regardless of the status of the open direction monitored external entrapment protection device(s). If gate is opening, and the operator's **inherent** entrapment protection system detects an obstruction, the operator will reverse approx. 2 inches and go into a hard shutdown. Operator reset button **MUST** be pushed to function again **OR** cycle operator's power.



4.3 Auxiliary Terminal Wiring

Type of wiring to be used on ALL external devices:
A) Type CL2, CL2P, CL2R, or CL2X.
B) Other cable with equivalent or better electrical, mechanical, and flammability ratings.

DoorKing Access Control System (Model 1833, 1835, 1837 or 1838) tracker system can be connected. This system can keep track of gate operator cycle count, shorted inputs, loop detector problems, any forced entry attempts, if the gate has struck anything during the open or close cycle, power interruptions, etc.

For more detailed information refer to the Tracker Board Installation and Wiring Manual, DoorKing P/N 2358-010.

Terminal 11 required only if the tracker board will activate the gate operator. Refer to the manual 2358-065 for detailed information.

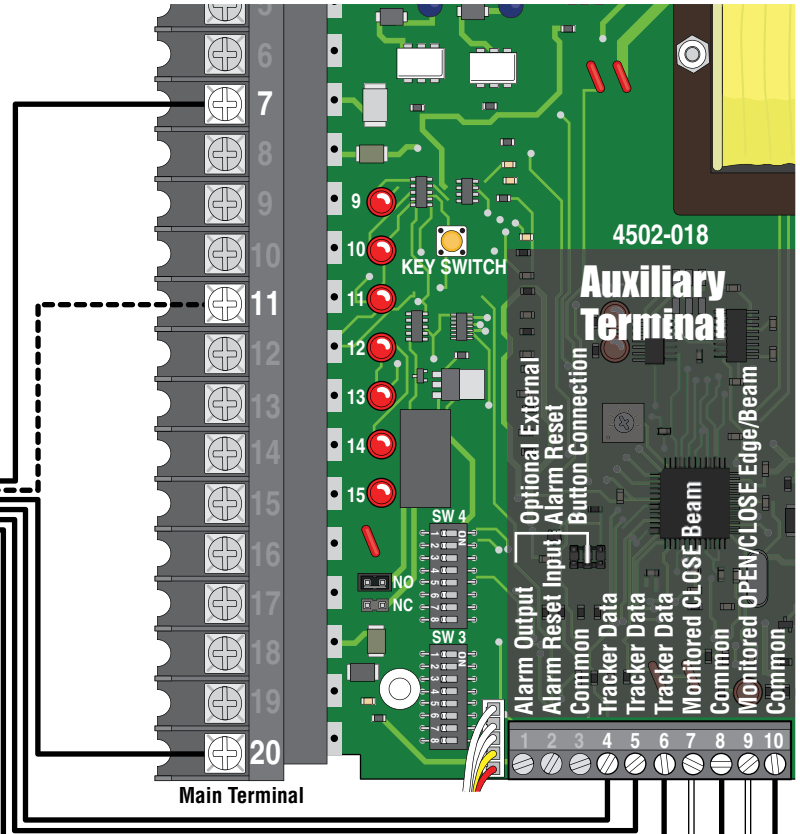
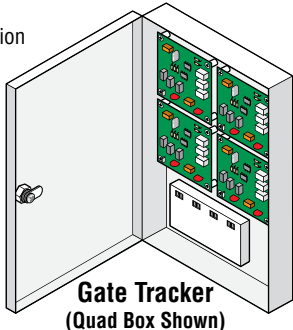

Sensors Power Note: Power devices using the built-in 24 VAC output terminal located on the operator (See previous page).

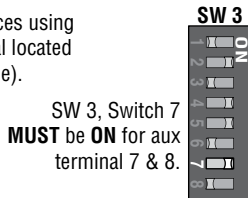

Monitored CLOSE Photo Sensor (will reverse gate to FULL open)

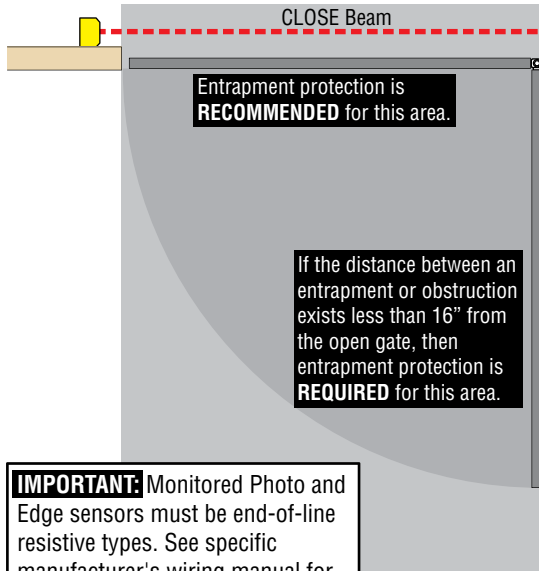

IMPORTANT: Monitored Photo and Edge sensors must be end-of-line resistive types. See specific manufacturer's wiring manual for more information.

External Entrapment Protection Devices:

In addition to the inherent reversing sensor system, this operator has a 10-pin Aux terminal for the connection of photo sensors-Type B1 and/or reversing edge-Type B2 (see next page) entrapment protection required for UL 325 standards.

Note: Only 1 monitored device can be connected to each input. An **OPTIONAL** Expansion Kit (sold separately) will allow connection for additional devices.

Entrapment Protection must be provided for the gate system where the risk of entrapment or obstruction exists. The operator will not run without one or more monitored type B1 or B2 entrapment protection devices in EACH entrapment area.

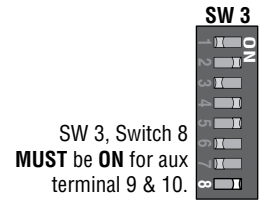

Monitored OPEN Photo Sensor (will reverse gate to FULL close)

4.3 Auxiliary Terminal Wiring Continued

Type of wiring to be used on ALL external devices:
 A) Type CL2, CL2P, CL2R, or CL2X.
 B) Other cable with equivalent or better electrical, mechanical, and flammability ratings.

WIRELESS Multiple Reversing Edge Configuration

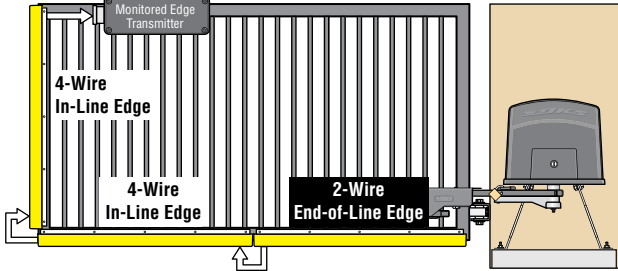

HARDWIRED Multiple Reversing Edge Configuration

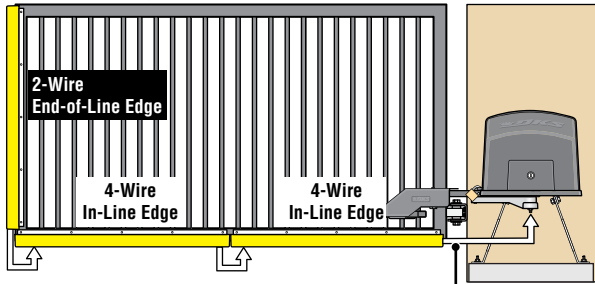

Wiring Multiple Reversing Edges
 (Add as many "4-wire" In-Line edges as needed)
 Reversing Edges are wired in series

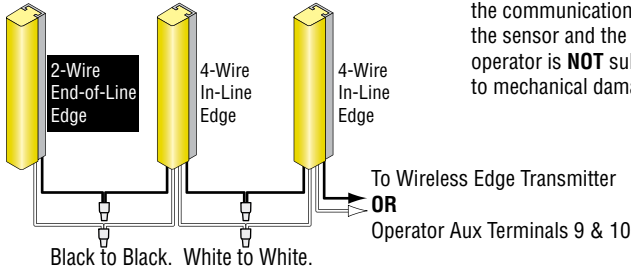

Wiring to Operator
 Hardwiring arranged so that the communication between the sensor and the gate operator is **NOT** subjected to mechanical damage.

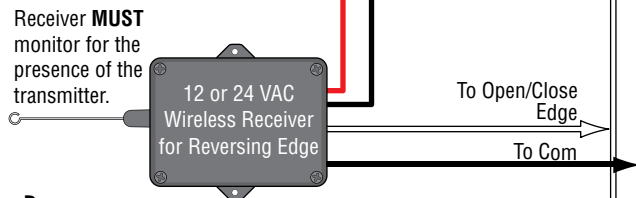
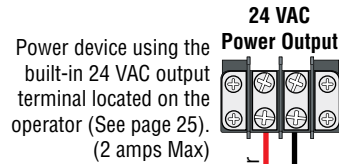
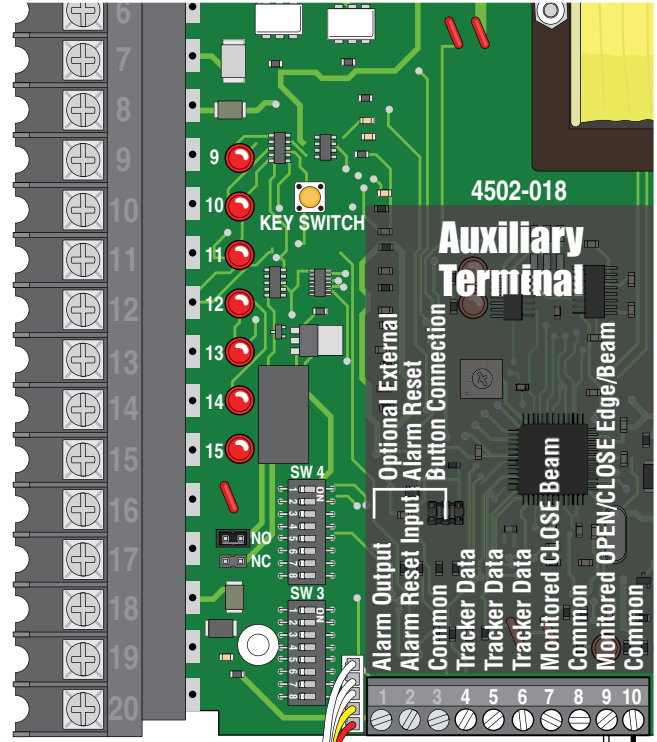

OPTIONAL Wireless Note: Refer to the instruction sheet that comes with the receiver/transmitter for more specific wiring and mounting instructions.

Monitored OPEN/CLOSE Reversing Edge (will reverse gate to FULL open or FULL close)

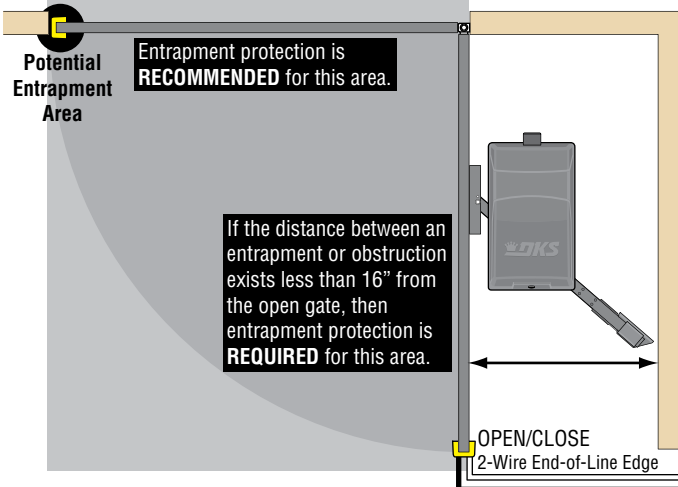

Entrapment Protection must be provided for the gate system where the risk of entrapment or obstruction exists. The operator will not run without one or more monitored type B1 or B2 entrapment protection devices in EACH entrapment area.

IMPORTANT: Monitored Photo and Edge sensors must be end-of-line resistive types. See specific manufacturer's wiring manual for more information.

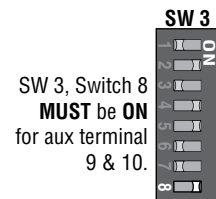

4.4 Dual Gates Multiple Photo Sensors Wiring Sample

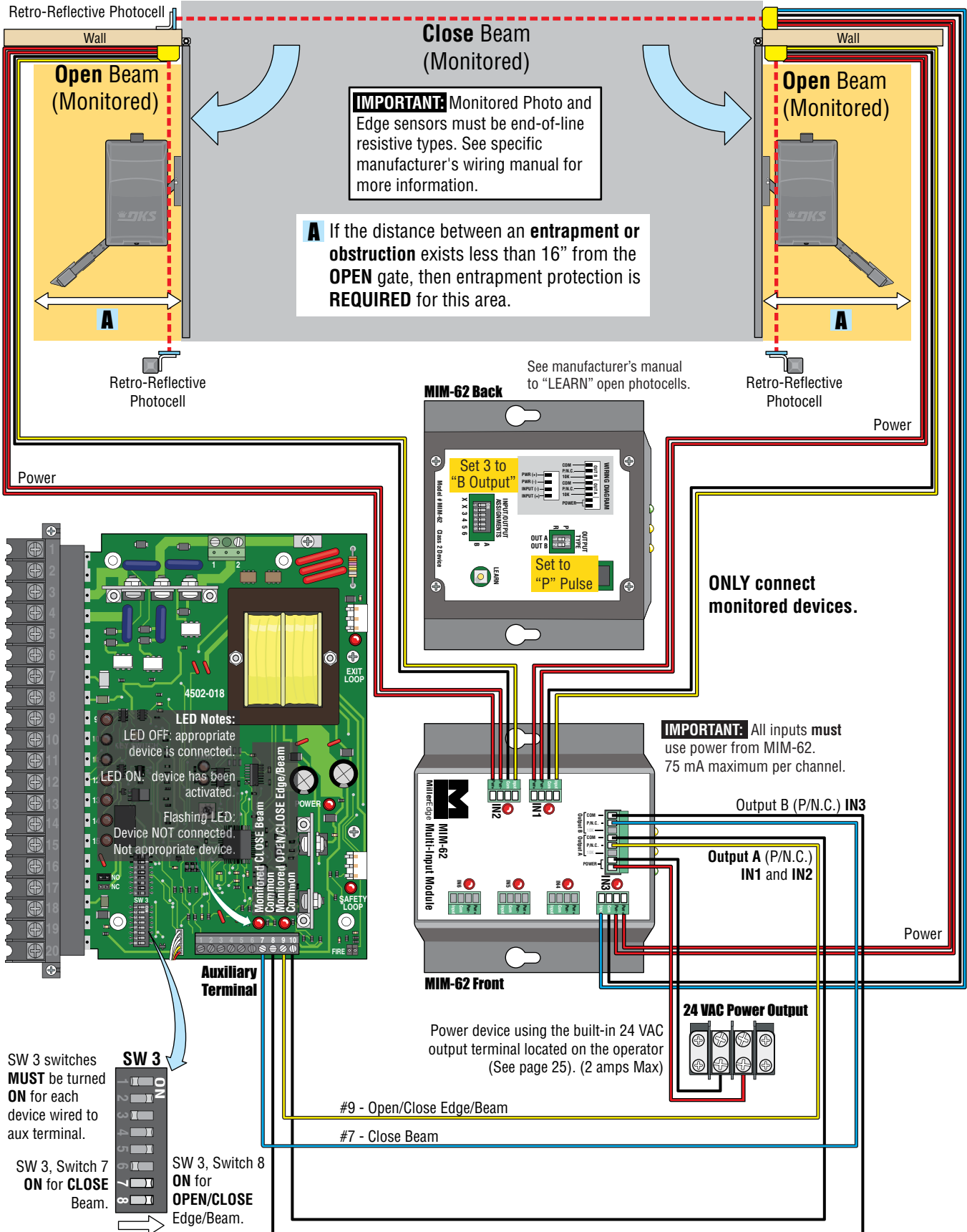

4.5 Loop Detector Wiring

To help protect the operator from accidentally closing on vehicles in the gate's path, DoorKing highly recommends that loops and loop detectors be installed. Loops are laid underneath, cut into asphalt or concrete driveways or buried beneath gravel and earth driveways. A loop detection system will sense a vehicle like a metal detector and send a signal to the gate operator preventing the gate from automatically opening or closing on a vehicle when it is in the gate's path. DoorKing recommends that a licensed installer perform this work.

- Loop detector wiring is shown for DoorKing plug-in loop detectors. If other loop detectors are used, refer to the installation instructions supplied with those detectors for wiring instructions.
- If other detectors are used, use a separate power supply to power these detectors.
- Loop layout shown is for a typical swing gate application with two-way traffic, or one-way exit only traffic.

DoorKing offers a free "Loop and Loop-Detectors Information Manual" PDF located at DoorKing's web site for more information. www.doorking.com

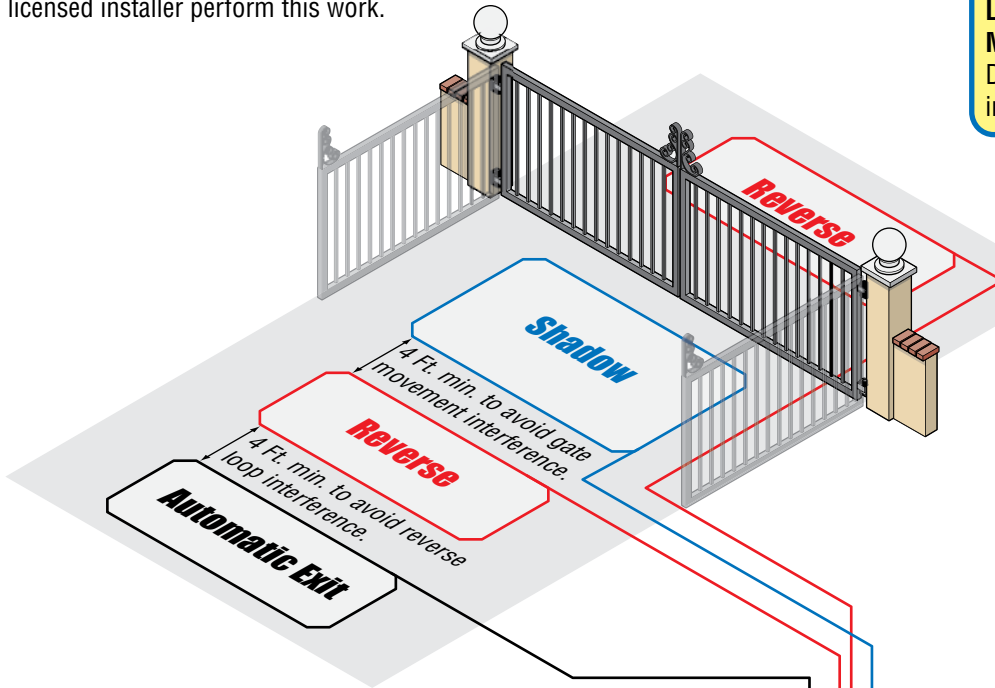

Automatic Exit Loop

Automatically opens the gate for exiting vehicles without having to use a transmitter or keypad. The exit loop can be placed a minimum of 4 feet away from the reverse loop or far enough away from the gate so the gate has started opening or even completely opened by the time you drive up to it (Free exit).

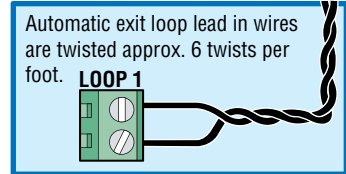

Reverse Loops

are placed on each side of the gate to prevent the gate from closing on a vehicle in the gate's path. They will stop or reverse the cycling of the gate while a vehicle is in or near the gate's pathway.

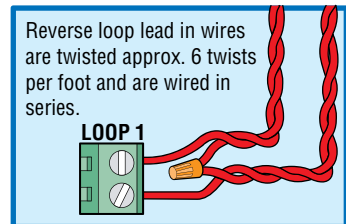

Shadow Loop

will ONLY HOLD the main gates in the Full Open Position when a vehicle is on the shadow loop. However, it WILL NOT stop or reverse the main gates once they start to close.

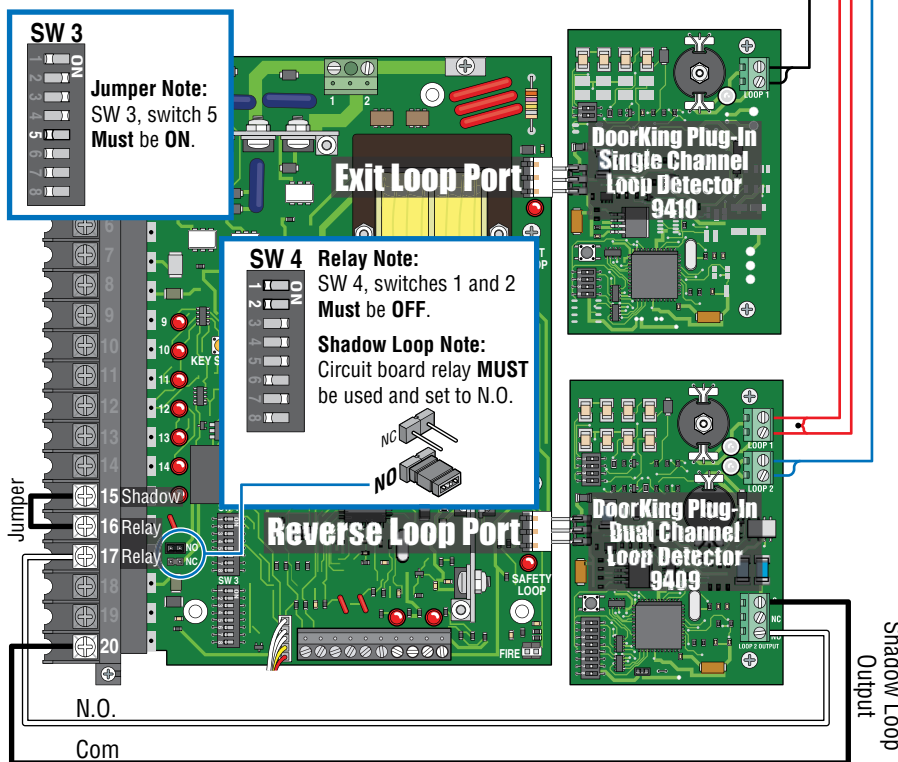
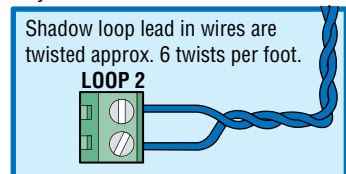

SECTION 5 - OPERATING INSTRUCTIONS

IMPORTANT SAFETY INSTRUCTIONS

WARNING - To reduce the risk of injury or death:

1. READ AND FOLLOW ALL INSTRUCTIONS.
2. Never let children operate or play with gate controls. Keep the remote control away from children.
3. Always keep people and objects away from gate. **NO ONE SHOULD CROSS THE PATH OF THE MOVING GATE.**
4. Test the operator monthly. The gate **MUST** reverse on contact with a rigid object or stop or reverse when an object activates the non-contact sensors. After adjusting the force or the limit of travel, retest the gate operator. Failure to adjust and retest the gate operator properly can increase the risk of injury or death.
5. Use the emergency release only when the gate is not moving and power has been shut-off.
6. **KEEP GATES PROPERLY MAINTAINED.** Read the owner's manual. Have a qualified service person make repairs to gate hardware.
7. The entrance is for vehicles only. Pedestrians must use separate entrance.
8. **SAVE THESE INSTRUCTIONS.**

5.1 Power and Reset Switch

Unlock the power switch cover and open to access the MAIN POWER and the operator RESET switch.

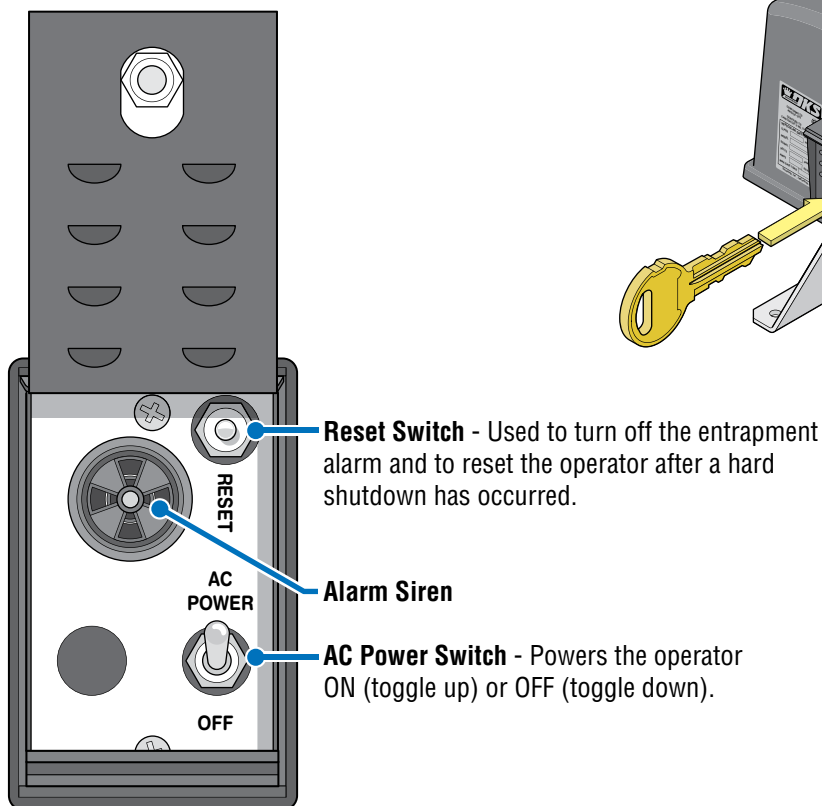

5.2 Shutdown Conditions

Under various entrapment conditions the operator will assume either a **soft** or **hard (alarm)** shutdown. To determine what type of reset action is required, you will need to understand how the different entrapment conditions affect the gate operator.

Soft Shutdown

This occurs in various situations where the inherent or external safety devices have been activated. In a soft shutdown condition, the operator **will not** respond to any input that was present when the entrapment protection device sensed an obstruction. If the gate stops at the open position, the operator will not respond to the automatic close timer.

- **Example 1** - A time clock keys the gate open in the morning and an entrapment protection device senses an obstruction prior to the gate reaching the full open position. If the entrapment is sensed by the inherent system, the gate will reverse and run back to the closed position. The time clock input is still present, but the gate will not re-open.

Note: In some systems, the time clock input comes from the telephone entry system relay. This same relay may also provide open commands for a card reader, MicroPLUS transmitters and the visitor telephone entry. If so, these devices will also be disabled in a soft shutdown condition.

- **Example 2** - If the gate is closing and an entrapment protection device is activated, the gate will either stop or reverse and run back to the open position, depending upon if the secondary or inherent device was activated. The automatic close timer will not close the gate.
- **Example 3** - Vehicle arrives at open loop and gate runs towards the open position. The inherent entrapment protection is activated. The gate reverses and runs back to the closed position. If the vehicle is still present at the open loop a soft shutdown condition does not occur. The loop input provides an immediate reset of the operator and the gate will again run to the open position.

Resetting a Soft Shutdown

In some conditions, a soft shutdown will reset as soon as the entrapment condition clears. For example, if a non-contact sensor (photo cell) is sensing an obstruction, the operator will stop the gate and assume a soft shutdown condition. When the photocell clears, the operator will return to normal operation.

When the operator is in a soft shutdown, activation of any "intended input" will reset the operator. An "intended input" includes any command, any standard safety input and any loop input. Activating any of these inputs will reset the gate. At that point the gate will return to normal operation. If the gate is open, the automatic close timer will then time out and close the gate.

Hard Shutdown (Alarm Activated)

A hard shutdown condition occurs when the inherent entrapment protection system has sensed **TWO** consecutive obstructions before the gate reaches the full open or closed position.

- **Example** - The gate is closing and the inherent entrapment protection system senses an obstruction and causes the gate to reverse direction. As the gate begins to run in the open direction, a second obstruction is sensed prior to the gate reaching the full open position. Once the second obstruction has been sensed, the operator will stop, the audio alarm will be activated and all standard inputs are shut down (including open commands, safety commands, loop inputs, etc.).

The audio alarm will sound for five minutes, or until the operator's reset button is pushed. After (5) five minutes the alarm will "chirp every 5 sec." and the hard shutdown condition will remain in affect until the reset button is pushed.

- After 5 minutes, the audio alarm will "chirp" every 5 seconds. This indicates that the operator is in a hard shutdown condition and the reset switch must be activated to reset the operator and silence the alarm.

Continued on next page

Resetting a Hard Shutdown

When the operator is in a hard shutdown condition (audio alarm activated or audio alarm “chirps” every 5 seconds), the only way to reset the gate operator and return it to normal operation is to activate the alarm reset input (auxiliary terminals 2 and 3).

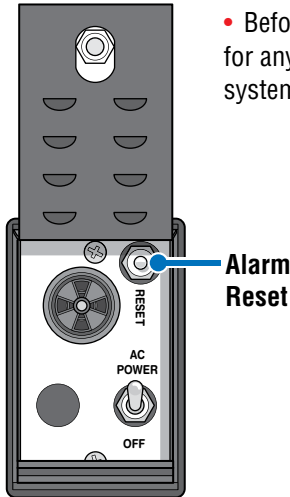

- Before resetting a hard shutdown, determine why the shutdown occurred. Inspect the gate for any obstructions along its path that could have activated the inherent entrapment sensing system. Inspect the gate and gate hardware.

Note: DoorKing operators have a built-in alarm reset push button mounted on the operator above the power ON-OFF toggle switch. Activating this button will return the gate operator to normal operation, but will not activate the gate operator.

Once the gate has been reset, an open or close command is needed to start the gate operator. Most activating commands will cause the gate operator to cycle to the open position. This includes activation of a key switch or open command and activation of an open loop. Activation of a close command will run the gate to the closed position.

Important Note: The gate operator will not lose its limit settings when a hard shutdown occurs.

5.3 Manual Gate Operation

This operator is equipped with a manual release system that will allow the gate to be pushed open in the event of a power outage or equipment failure.

Never attempt to manually push open any gate with an operator attached to it until you have verified that power to the operator has been shut-off.

Emergency Vehicle Access Conditions

The automatic vehicular gate system must be designed to allow access to emergency vehicles under different operating conditions.



1. During normal powered operation, emergency vehicles access the gate by use of the **Emergency Vehicle Access Device** installed on your gate system. The type of device that is used in your community is dependent on your city codes. These devices may include (but are not limited to) Fire Department lock boxes, Click-2-Enter radio receivers, strobe light sensors, siren sensors, etc.

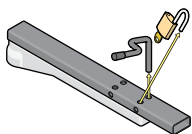

2. In the event of a primary (AC) power failure and a back-up system (DC) power failure (low charged or dead batteries for example), the system must have a release system to allow the gate to be **Manually Operated**.

FAIL-SAFE Manual Operation

The FAIL-SAFE manual operation system is the most reliable and safest method for placing an automated gate in manual operation and is the preferred method of emergency gate operation under worse case conditions by many Fire Chiefs and Building Inspectors and is typically used in CLASS I and CLASS II applications. This system requires no keys, cranks or tools for manual gate operation and is completely automatic. This prevents any delays for emergency vehicle access in the event that a power outage has occurred.

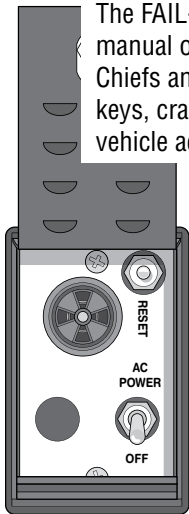

- When AC power is removed (power failure or switch power off), the operator "FAILS" in a "SAFE" condition allowing the gate to be manually pushed open **without** the need of any tools, keys, cranks or other devices. This assures emergency vehicle access under the worst-case conditions.
- **For manual FAIL-SAFE gate operation**, turn power to the operator OFF. Once power is OFF, the gate can be manually operated.

1 Pull the gate crank arm (arm that is attached to the operator shaft) away from the gate so the arms are not in a straight line.

2 Go to the end of the gate and pull it open.

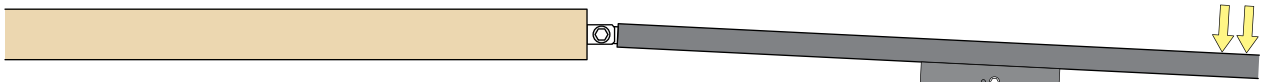

Note: If an attempt is made to force the gate open under **NORMAL** operating conditions (AC power present), a tamper protect circuit (SW 4, switch 8 **ON**) will detect the forced entry and will start the motor to return the gate to the closed position.

If the Gate Tracker reporting is in use, a forced entry attempt transaction will be sent to the DoorKing access control system at this time.



1

Pull Crank Arm

- NO AC power Available.

2

Manual Release

In addition to FAIL-SAFE manual operation, this operator also employs a locked release pin to place the gate in manual operation when AC power is removed.

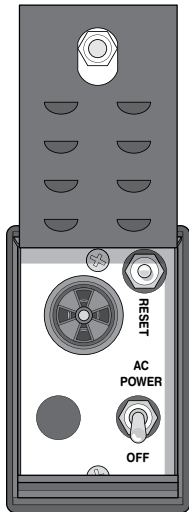

To Manually Release Arm, turn AC power to the operator OFF.

Remove padlock and locking pin from crank arm and gate can be manually operated. Crank Power Arm will remain stationary during gate movement.

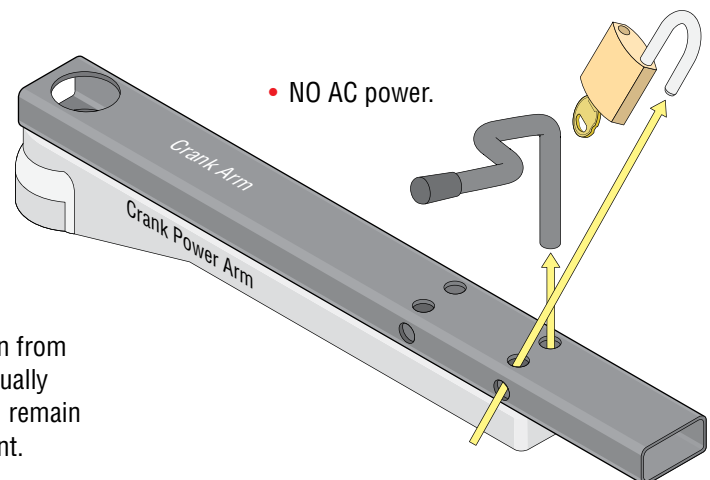

- NO AC power.

SECTION 6 - MAINTENANCE AND TROUBLESHOOTING

Inspection and service of this gate operator by a qualified technician should be performed anytime a malfunction is observed or suspected. High cycle usage may require more frequent service checks.

6.1 Maintenance

When servicing the gate operator, always check any (external) safety devices (loops, photo eyes, etc.) for proper operation. If external safety devices cannot be made operable, do not place this operator in service until the malfunction can be identified and corrected.

Always check the inherent reversing system when performing any maintenance. If the inherent reversing system cannot be made operable, remove this operator from service until the cause of the malfunction is identified and corrected. Keeping this operator in service when the inherent reversing system is malfunctioning creates a hazard for persons which can result in serious injury or death should they become entrapped in the gate.

When servicing this gate operator, always turn power **OFF!!**

⚠ Every time the operator is powered up, the First open command will automatically set the open and close limits of the gate. (See page 22).

Operator Component	Maintenance	Monthly Interval		
		1	6	12
Warning Signs	Check that warning signs are on BOTH sides of the gate area.	✓		
Alarm	Activate the inherent reverse system by blocking the gate with a solid object. When the gate reverses, block the gate in the opposite direction prior to the limit being reached. The entrapment alarm should activate. Press the reset button to silence the alarm.	✓		
Arms	Check set screws and nuts. Check bushings for wear.		✓	
Drive Belt	Check for alignment, tightness and wear.		✓	
Fire Dept.	Check emergency vehicle access device for proper operation.	✓		
Gate	Inspect for damage. Check gate hinges for wear and grease if necessary.		✓	
Gear	Inspect for wear. Grease if necessary. Use only EP Molybdenum Disulfide (Moly D) grease (DoorKing P/N 2600-770)		✓	
Grease	Main shaft zert fitting.		✓	
Inherent Reverse System	Check that the gate reverses on contact with an object in both the opening and closing cycles. See page 41. Adjust the clutch if necessary.	✓		
Loop(s)	Check vehicular reverse and shadow loops for proper operation.	✓		
Manual Release	Check manual release for proper operation. See page 40.	✓		
External Entrapment Devices	Check monitored external device(s) stop or reverse the gate when activated. See page 41.	✓		
Worm Gear	Inspect for wear and proper alignment.		✓	
Complete System	Complete check of gate and gate operating system.			✓

6.2 Troubleshooting

Have a good VOM meter to check voltages and continuity. A Meg-Ohm meter capable of checking up to 500 meg-ohms of resistance is necessary to properly check the integrity of the ground loops. When a malfunction occurs, isolate the problem to one of three areas: 1) the operator, 2) the loop system, 3) the keying devices. **Use caution when checking high voltage areas: terminals 1 through 6, the motor capacitor and the motor.**

1. Check the input indicator LEDs. They should only come ON when a keying device (card reader, push button, etc.) is activated. If any of the input LEDs are ON continuously, this will cause the gate operator to hold open. Disconnect the keying devices one at a time until the LED goes OFF.
2. Check any external safety devices. Any short or malfunction in these devices can cause the gate operator to stop or to hold open.
3. A malfunction in a loop or loop detector can cause the gate operator to hold open, or to not detect a vehicle when it is present over the loop. The LEDs next to the loop detector ports on the operator circuit board will light only when the loop has detected an object above it. If the LEDs stays on after the object has gone, then the loop detector has malfunctioned. Pull the loop detector circuit boards from the loop ports on the operator circuit board. If the malfunction persists, the problem is not with the loop system. For more information on trouble shooting loops and loop detectors, refer to your loop detector instruction sheet and to the DoorKing Loop and Loop Detector Information Manual.
4. Check to be sure that there are no shorted or open control wires from the keying devices to the gate operator. If a keying device fails to open the gate, press the key momentarily jumper across terminals 11 and 20 on the gate operator circuit board. If the gate operator starts, this indicates that a problem exist with the keying device and is not with the gate operator.
5. If a three-button control station (open-close-stop) is connected to this gate operator, check for proper wiring. Only a DoorKing three button control station (P/N 1200-006) can be used with this gate operator. Others will cause a malfunction.
6. Check the high voltage supply. A voltage drop on the supply line (usually caused by using too small supply voltage wires) will cause the operator to malfunction. Refer to the wire size chart in section 2.1 on page 17.

Symptom	Possible Solution(s)
Operator will not run. Power LED is OFF.	<ul style="list-style-type: none"> • Check that power to the operator is turned ON. • Transformer may be overheated. Turn power off and allow board to cool for several minutes then retest. Check for low 115 VAC power and low voltage shorts. • Check for 115 VAC at terminals 2 and 3. If voltage measures OK, check the terminal strip or replace the circuit board.
Operator will not run. Power LED is ON.	<ul style="list-style-type: none"> • Insure that a minimum of one (1) external entrapment protection device is connected in EACH entrapment area and the inputs are connected and enabled (UL 325 DIP-switches are turned ON). • Momentarily jumper terminal 11 to terminal 20. If the input LED does not come ON, check the terminal strip or replace the circuit board. If LED does come ON, proceed to next steps. • Check Motor: <ul style="list-style-type: none"> - Momentarily jumper terminal 11 to terminal 20. If the input LED does not come ON, check the terminal strip or replace the circuit board. If LED does come ON, proceed to next steps. - Remove circuit board. With power ON, momentarily jumper terminal 3 to terminal 4 with a 14 AWG insulated jumper wire. CAUTION – HIGH VOLTAGE. The motor should run. - With power ON, momentarily jumper terminal 3 to terminal 5 with a 14 AWG insulated jumper wire. CAUTION – HIGH VOLTAGE. The motor should run in the opposite direction of the above step. - If the motor runs in both steps above, replace the control board. If the motor does not run, or runs in only one direction, problem can be a bad motor, motor capacitor, wire connections from the control board to the motor or a bad control board.
Secondary operator motor will not run.	<ul style="list-style-type: none"> • Check that SW 4, switch 7 is OFF and SW 3, switch 4 is ON. • Remove circuit board. Momentarily jumper terminal 3 to one of the secondary motor terminals, then to the other secondary motor terminal with a 14 AWG insulated jumper wire. CAUTION – HIGH VOLTAGE. The secondary motor should run one way, then the other way as power is applied to each terminal. • If the secondary motor runs in both directions, replace the control board. If secondary motor does not run, or runs in only one direction, problem can be in the wiring from the primary to secondary operator, bad secondary motor or motor capacitor.

Continued on next page

Symptom	Possible Solution(s)
Operator will not run, entrapment protection input(s) LED is ON.	<ul style="list-style-type: none"> • The entrapment protection device has a fault or the wiring to it is shorted.
Operator will not run, entrapment protection input(s) LED is Blinking.	<ul style="list-style-type: none"> • The entrapment protection device is not connected or the wiring to it is open.
Gate opens a short distance, then stops and reverses.	<ul style="list-style-type: none"> • Check that the clutch is adjusted properly and is not slipping. • Disconnect the gate from the gate operator and check that the gate swings freely without any binding. • Check that SW 4, switch 7 is set correctly. • Check the PULSE LED on the circuit board. PULSE 1 should blink as the primary (or single) operator is running. PULSE 2 should blink as the secondary operator is running. If either PULSE LED is not blinking as the respective operator is running, check that the magnetic sensor is within 1/32 inch of the magnetic counter ring. • Replace the magnetic sensor. • Continue troubleshooting or replace the circuit board.
Gate opens but will not close.	<ul style="list-style-type: none"> • Check the input LEDs. Any ON will hold the gate open and indicates a problem with a keying device. • Check the external safety devices. Any activated will hold the gate open and indicates a problem with the safety device. • Check the loop detectors. Any activated can hold the gate open and indicates a problem with the loop detector or ground loop. • Operator may be in a “soft shutdown.” Activate any keying device to determine if operator returns to normal operation. • If automatic close is desired, be sure SW 4, switch 4 is ON. • Check motor as described on previous page.
Gate closes but will not open.	<ul style="list-style-type: none"> • Operator may be in a “soft shutdown.” Check input LEDs on terminals 11-13. If any are ON, momentarily disconnect, then re-connect the wire going to the respective terminal. Operator should open. • Check to be sure that the operator is running in the proper direction. Turn power OFF, and then back ON. Activate a keying device. Operator should run in the open direction. If operator runs in the close direction, turn power OFF and change direction switch SW 3, switches 1 and/or 2. Go to above section if operator now opens but will not close. • Be sure that the respective LED on the control board lights when the keying device connected to the respective terminal is activated. If LED does not light, momentarily place a jumper wire from terminal 20 to the input terminal being checked. If LED lights and gate opens, problem is with the keying device. If LED does not light, replace control board. • Check motor as described on previous page.
Gate starts to close, then reverses to open.	<ul style="list-style-type: none"> • Check that the clutch is adjusted properly and is not slipping. • Disconnect the gate from the operator and check that the gate operates freely without any binding. • Check the loop detector LEDs and input LEDs. Any that flash ON will cause the gate to reverse. • If a shadow loop is used, check for proper wiring. A mis-wired shadow loop detector will cause the gate to reverse. • Check the PULSE LED on the circuit board. PULSE 1 should blink as the primary (or single) operator is running. PULSE 2 should blink as the secondary operator is running. If either PULSE LED is not blinking as the respective operator is running, check that the magnetic sensor is within 1/32 inch of the magnetic counter ring. • Replace the magnetic sensor. • Continue troubleshooting or replace the circuit board.
Gate closes and then re-opens.	<ul style="list-style-type: none"> • Check for any input or loop detector LEDs that are ON. • Check that the operator is running in the proper direction (see “gate closes but will not open” above). • Check that SW 4, switch 5 is set correctly.
Alarm sounds for 5 minutes and then beeps once every 5 seconds. Operator will not run.	<ul style="list-style-type: none"> • Operator is in a “hard shutdown” condition. Reset switch must be activated to return operator to normal operation.
Operator has intermittent functionality problems that vary.	<ul style="list-style-type: none"> • Terminal #7 and/or #8 mA power has been exceeded. Check total amp draw of connected device(s).

6.3 Accessory Items

UL 325 Monitored Entrapment Protection Devices available for the model 6050 and 6100 swing gate operators.

Type B2 Contact Sensors (Reversing Edge)

DoorKing 8080 Series Sensing Edges
Miller Edge Sensing Edges - all models with a T2 (resistive) termination.
Miller Edge wireless monitored transmitter/receiver kit model RB-G-K10
ASO GMBH Sentir GF Series sensing edges

Type B1 Non-contact Sensors (Photo Cell)

DoorKing Model 8080-057 Retro-Reflective Photocell
Miller Edge Reflective-Guard Model RG
Miller Edge Prime-Guard Model PG
EMX Industries Model IRB-MON
EMX Industries Model IRB-RET
Omron Model E3K-R10K4
Seco-Larm Model E-936-S45RRGQ
Seco-Larm Model E-960-D90GQ

Monitored Expansion Kit

Miller Edge Multi-Input Module Model MIM-62

Accessory items available for the model 6050 and 6100 swing gate operators.

Plug-In Loop Detector - Detectors plug directly into ports on circuit board simplifying wiring.

Single channel detector - P/N 9410-010
Dual channel detector - P/N 9409-010
Single channel detector with aux relay - P/N 9411-010
Single channel low power draw detector - P/N 9416-010
Dual channel low power draw detector - P/N 9415-010

External Loop Detector

Reno A&E 12/24 VDC or 24 VAC - 9402-045
Reno A&E 120 VAC - 9402-047
Carlo Gavazzi 24 VAC/VDC - 9402-044
Diablo 10-30 VAC/VDC low power draw - 9402-050

Magnetic Lock - Magnetic Gate Lock Kit provides an excellent means to secure swing gates and is a fail-safe device allowing emergency vehicle access upon power outage. P/N 1216-080 and P/N 1216-081

3-Button Control Station - Three button interior and exterior control stations provide manual open-close-stop gate operation.

P/N 1200-006 (Exterior) and 1200-007 (Interior, mounts into single-gang electrical box)

115 VAC Heater with Fan Assembly Kit - Thermostatically controlled heater and fan for cold and hot environments.

For 115 VAC input power ONLY. P/N 1601-154

Interconnection Cable - Interconnect wire cable contains all the necessary wires to interconnect primary / secondary operators.

Cable length 30 feet. P/N 2600-755
Cable length 40 feet. P/N 2600-756
Cable length 50 feet. P/N 2600-757

High Voltage Kit - Alter the input AC voltage on a 115 VAC 6500 to 208, 230, 460 or 575 VAC. P/N 2600-266

Time Clock - 7 day time clock can be used to automatically open gate at pre-set time and days.

Compact clock fits inside the operator. P/N 2600-791 - 7 day clock

Uphill Arm Pivot Assembly - Ball joint pivot gate connection used on uphill or downhill opening swing gates. P/N 6500-490

Torsion Rods - Torsion rod assembly is used on uphill swing gates for counter balance.

P/N 1203-084

Hinges - Heavy-duty ball bearing hinges provide easy swing gate operation.

P/N 1200-009, P/N 1200-019, P/N 1200-039.

Surge Devices - High and low voltage surge suppressors help prevent circuit board failure caused by lightning strikes and power surges.

P/N 1879-010 - High Voltage
P/N 1878-010 - Low Voltage

Molly D Grease - Molybdenum Disulfide (Moly D) multi-purpose grease for worm gear. P/N 2600-770 - 14 oz. tube.

Speed Bumps - Prefabricated six-foot speed bump reduces traffic speed through gate system. P/N 1610-150

Model 6050 / 6100

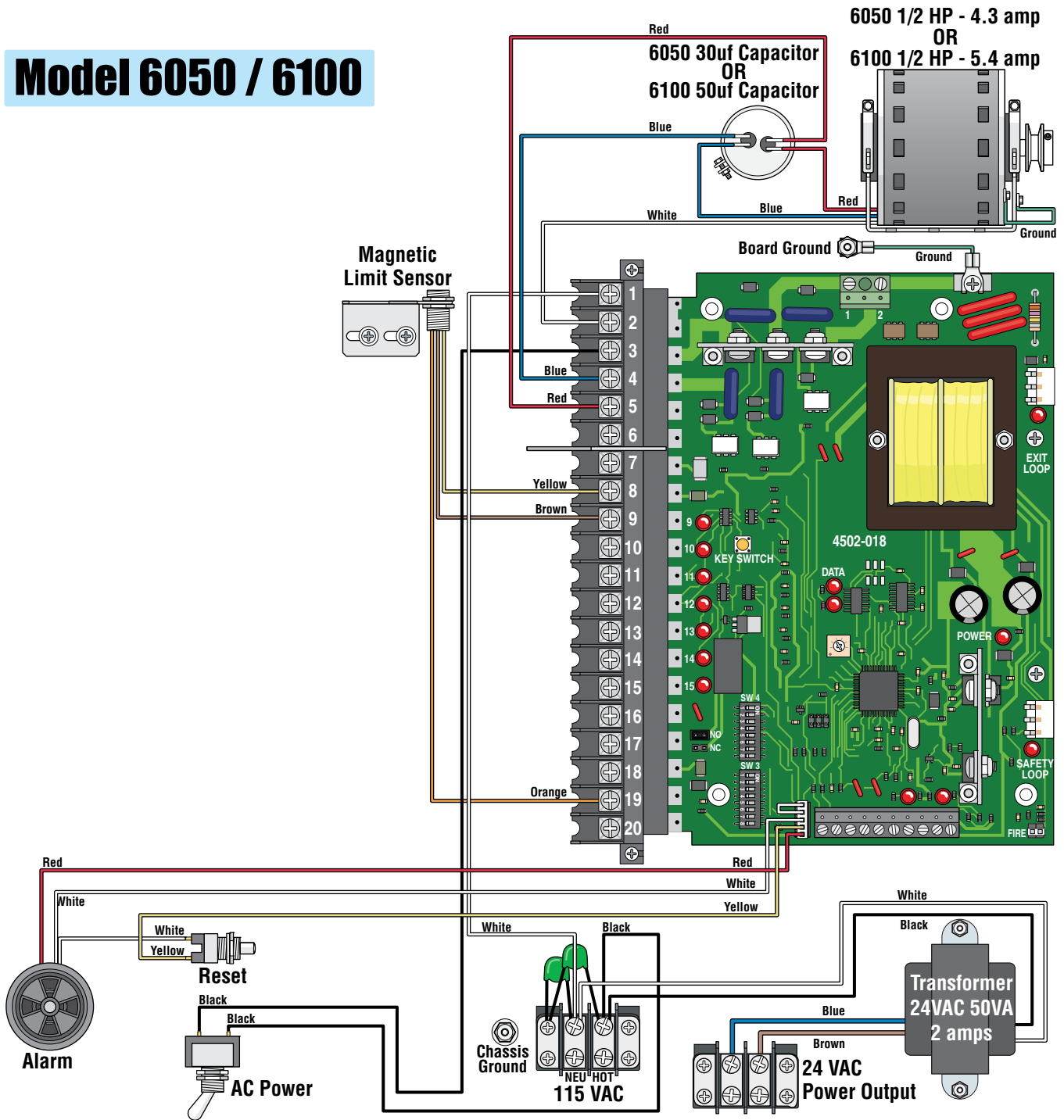

Model 6050 / 6100 Secondary Operator

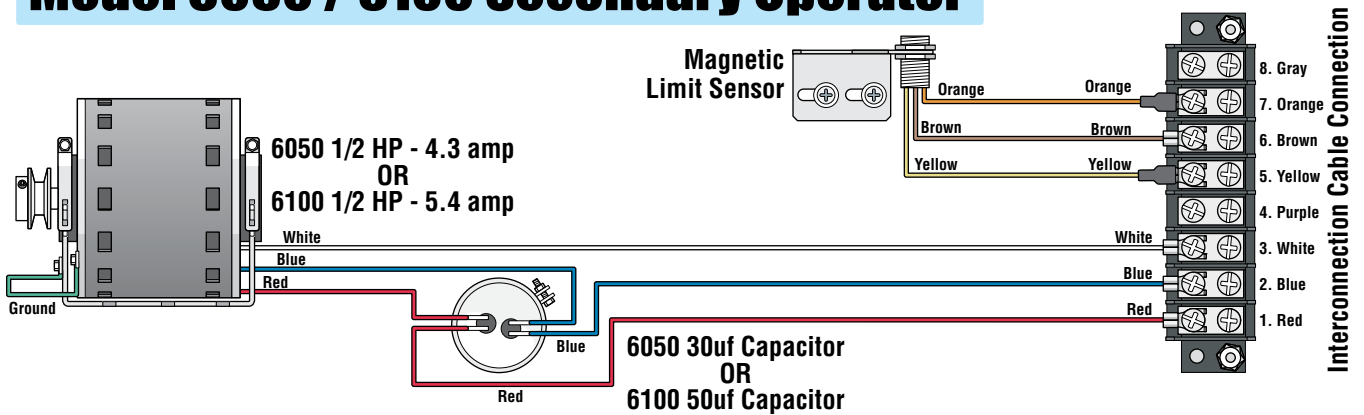

SECTION 7 - OWNER OF THE GATE OPERATOR

7.1 Alarm Sounding OR “Chirping” and Gate WILL NOT Operate

Operator is in a HARD Shutdown Condition: The alarm will sound for (5) five minutes. After five minutes the alarm will start “Chirping” every 5 seconds and continue “Chirping” until operator gets reset.

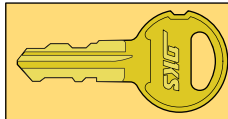

A KEY has been supplied that will unlock the power switch cover on this gate operator.

Note: The owner of the gate operator is responsible for the KEY availability.

When Alarm is Sounding OR “Chirping”

ALWAYS CHECK THE ENTIRE GATE AREA FOR ANY OBSTRUCTIONS OR DAMAGE FIRST.



- If a Fire Dept Access Device has been activated by **emergency personnel**, then operator can be **reset** and put back into normal operation again. Alarm will **always** sound when this access device gets activated.
- If the cause of the alarm **CAN** be identified and **CORRECTED**, then operator can be **reset** and put back into normal operation again.
- If the cause of the alarm **cannot be corrected**, shut-off power and **DO NOT** place this operator back into service until the malfunction can be identified and **CORRECTED**.

IMPORTANT! Putting this gate operator back into service **WITHOUT CORRECTING** the cause of the alarm could result in serious injury or **DEATH!**

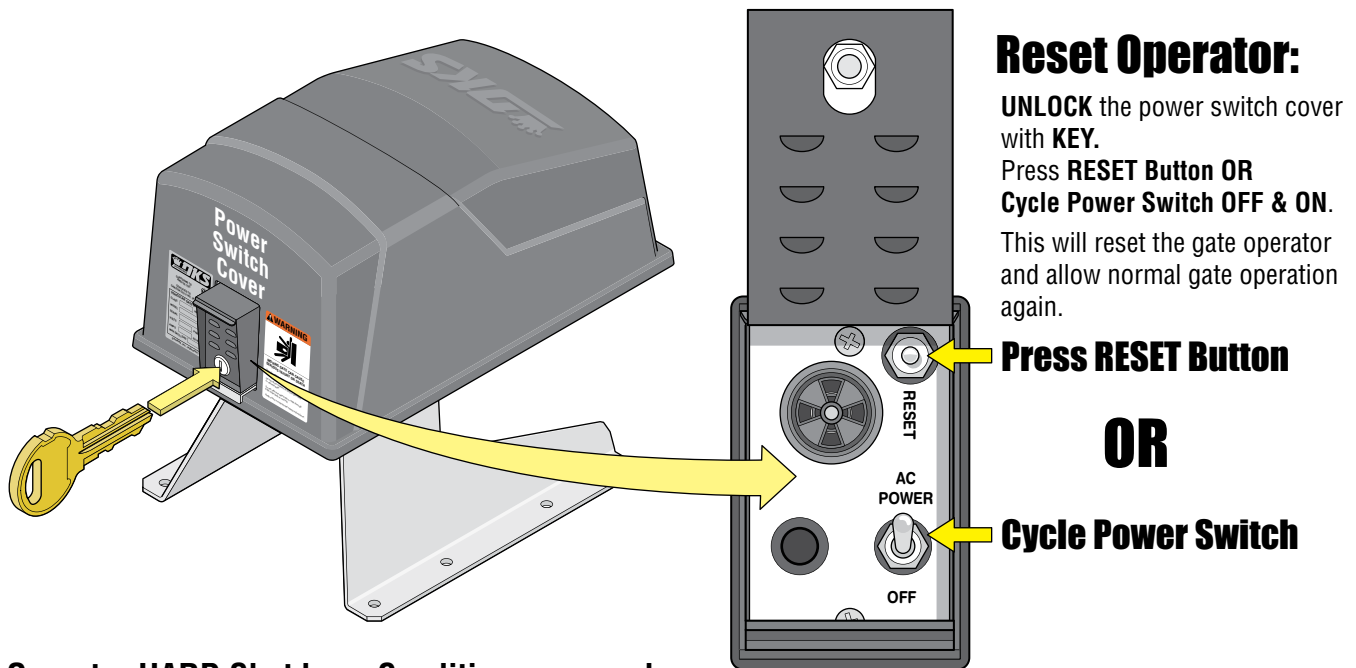

Reset Operator:

UNLOCK the power switch cover with **KEY**.

Press **RESET Button OR Cycle Power Switch OFF & ON.**

This will reset the gate operator and allow normal gate operation again.

Press RESET Button

OR

Cycle Power Switch

Operator HARD Shutdown Condition occurs when:



1. Fire Department (Emergency Access) input has been activated by Police, Fire Department, EMT, Ambulance etc.
2. The inherent entrapment protection system (Type A) gets activated **TWO** consecutive times before the gate completes the open cycle **OR** the close cycle.
3. The reversing edge contact sensor (Type B2) gets activated and reverses, but before the gate completes the reverse cycle the inherent entrapment protection system (Type A) gets activated.

Please read **SECTION 5 - OPERATING INSTRUCTIONS** for more information about operating this gate operator.

7.2 Manual Gate Operation

Caution: NEVER attempt to manually operate the gate until you have VERIFIED that ALL power to the gate operator has been SHUT-OFF!

Please read **SECTION 5 - OPERATING INSTRUCTIONS** for more information about operating this gate operator.

FAIL-SAFE Manual Operation

Gate can be **IMMEDIATELY** manually operated (pushed open) during a power outage. **NO** Key is required.

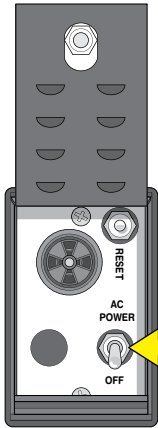

Turn-OFF POWER

• For manual **FAIL-SAFE** gate operation, turn power to the operator OFF. Once ALL power is OFF, the gate can be manually operated.

1 Pull the gate crank arm (arm that is attached to the operator shaft) away from the gate so the arms are not in a straight line.

2 Go to the end of the gate and pull it open.

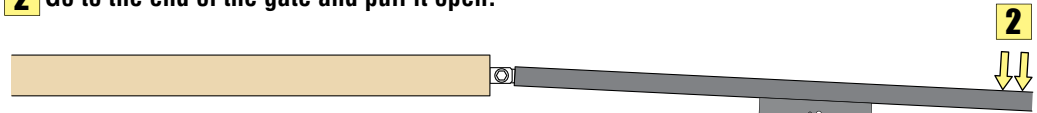

• NO AC power Available.

A "STRONG" Pull is Needed!

Note: If the Gate **Tamper Protect** is in use, a forced entry attempt transaction will be sent to the DoorKing access control system at this time.

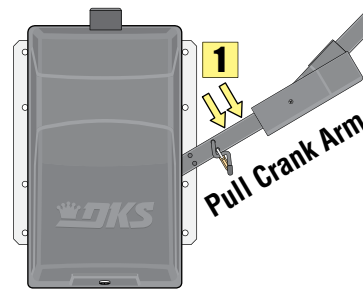

Manual Release

In addition to FAIL-SAFE manual operation, this operator also employs a locked release pin to place the gate in manual operation when AC power is removed.

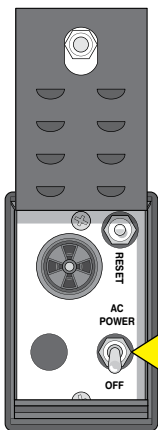

To Manually Release Arm,
turn AC power to the operator OFF.

Turn-OFF POWER

• NO AC power.

Note: The **owner** of the gate operator is responsible for the padlock **KEY** availability.

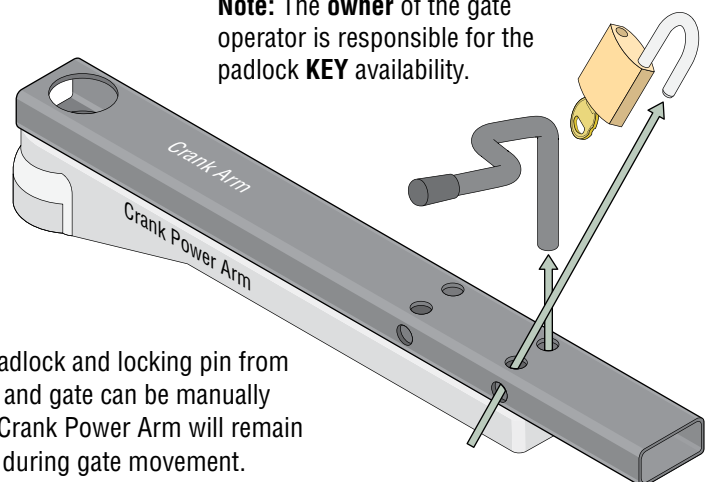

Remove padlock and locking pin from crank arm and gate can be manually operated. Crank Power Arm will remain stationary during gate movement.

7.3 Gate Operator's Monthly Checkup

Caution: Make SURE gate area is clear BEFORE testing the gate operator!

DO NOT repair or adjust gate systems yourself. Contact a trained gate systems technician with any questions or to make any repairs or adjustments. If you feel uncomfortable performing any of these inspections or testing, a qualified service technician will perform the visual inspections and testing for you.

You can find a trained service technician at DoorKing's "Dealer Locator" at www.doorking.com

Visual Inspection

Visually inspect the rollers, fasteners, brackets and other gate hardware for proper alignment, proper tightness, and signs of damage, breakage, looseness, rust or wear. Moving parts should be lubricated and should not be squeaking.

Visually inspect wiring for fraying or exposure. If a malfunction is found, contact a trained service technician to make adjustments or repairs.

Test Built-In Reversing Sensor

Begin with the gate in the fully **OPEN** position. Stand just outside the path of the gate and close the gate (typically auto-timer will time-out and close gate automatically). As the gate is **closing**, firmly press a solid object against the end of the gate frame in the direction opposing the travel of the gate. The gate should **stop** within 2 sec. and **reverse** to the **OPEN** position. Another input command is needed before the gate will reset and close again. Repeat this test while **opening** the gate. Start from the fully **CLOSED** position. While **opening**, gate should **stop** and **reverse** to the **CLOSE** position. If gate does **NOT** respond like it should in **either** direction of gate travel, contact a trained service technician to make adjustments or repairs.

Test Photo Sensors

If the gate has a photo sensing device protecting the path of a **closing gate**, perform the following test. Begin with the gate in the fully **OPEN** position. Stand just outside the path of the gate and close the gate (typically auto-timer will time-out and close gate automatically). Pass an object across the path of the closing photo sensing beam. The gate should **stop** within 2 sec. and **reverse** to the **OPEN** position. Typically the auto-timer times out and gate closes again.

If the gate has a photo sensing device protecting the path of a **opening gate**, start from the fully **CLOSED** position. **OPEN** gate. Pass an object across the path of the opening photo sensing beam. The gate should **stop**, the gate will resume opening when the beam is clear. If gate does **NOT** respond like it should in **either** direction of gate travel, contact a trained service technician to make adjustments or repairs.

Test Reversing Edges

If the gate has a reversing edge(s) protecting the path of a **closing gate**, perform the following test. Begin with the gate in the fully **OPEN** position. Stand just outside the path of the gate and close the gate. As the gate is closing, firmly press a solid object against the reversing edge in the direction opposing the travel of the gate. The gate should **stop** within 2 sec. and **reverse** to the **OPEN** position (typically auto-timer will time-out and close gate automatically). If the gate encounters **another** obstruction before it is closed, the gate will **stop** and reverse to the **OPEN** position **again**. A input command is needed before the gate will reset and close again, auto-timer will **NOT** close gate (Typically, press your remote button for input command).

If the gate has a reversing edge(s) protecting the path of a **opening gate**, starting from the fully **CLOSED** position. Stand just outside the path of the gate and open the gate. **OPEN** gate. As the gate is opening, firmly press a solid object against the reversing edge in the direction opposing the travel of the gate. gate should **stop** and **reverse** to the **CLOSE** position. If gate does **NOT** respond like it should in **either** direction of gate travel, contact a trained service technician to make adjustments or repairs.

Note: This gate operator uses high levels of force to move the gate and most people underestimate the power of these systems and do not realize the potential hazards associated with this system if **NOT** maintained properly.

Scheduled maintenance visits are offered by most qualified service technicians to MAINTAIN your gate operator system.

7.4 New Installation Checklist for Installer and Property Owner

Instructions: Check the space next to each item (“✓”) to indicate that it has been addressed by installer **AND** property owner. If it is not applicable, enter N/A. Please note that the checklist is intended to be a summary of many **important** automated vehicular gate aspects, **But may not inclusively identify all potential hazards of every specific gate system installation.**

Each item listed and checked has been examined by the Installer and is CLEARLY understood by the Property Owner.

Installer	Property Owner	Description
		The operator is installed on a gate used for vehicles only. Verify that separate pedestrian access is provided or available, and the access is such that pedestrians cannot come in contact with the moving vehicular access gate during its entire length of travel.
		Gate/Hardware: Insure that there is a means to prevent the gate from falling over in the event of a roller or hinge failure. Insure the gate has physical limit stops and that gravity will not initiate motion of the gate. Insure that all rollers are guarded or covered to eliminate the possibility of a finger being inserted between the roller and gate.
		<p>Slide Gate: Insure that the maximum opening in the gate and in that portion of the adjacent fence that the gate covers when the gate is in the open position is such that a 2 ¼" sphere cannot pass through the openings up to 72 inches above the ground or to the top of the gate, whichever is less. If the gate and adjacent fence do not meet this requirement, wire mesh (or other means) must be added to meet this requirement before placing the gate system in operation.</p> <p>Insure that any gaps between the slide gate and stationary posts/pilasters is less than 2 1/4" and that these areas are protected with an entrapment protection device.</p>
		The gate operator system is in compliance with the entrapment protection requirements of UL 325 . Identify all potential entrapment zones and ensure they are protected. Potential pinch areas have been guarded so as to be inaccessible OR have a contact (reverse edge) and/or non-contact (photocell) obstruction sensing devices installed. Verify that the system has in place external entrapment protection, independent from the inherent entrapment protection. Edge sensors or photocells are typical, other means are possible. For more information see your specific installation/owners manual for entrapment protection installation and locations.
		The installer has properly adjusted the inherent entrapment protection feature on the gate operator, and has tested the gate to make sure that the gate stops and reverses a short distance upon striking an immovable object.
		Check that placement of user operational controls are six (6) or more feet away from the gate. If any operational control is closer than six (6) feet to the gate, DO NOT place the automated vehicular gate into service.
		Warning signs have been installed so that they are visible from each side of the gate - whether the gate is open or closed.
		The installer has instructed the property owner in the proper use of the gate operator and has reviewed the operational functions, obstruction-sensing devices, alarm, and reset as outlined in your specific installation/owners manual.
		The installer has instructed the property owner in the proper use of the operator's manual release feature as outlined in your specific installation/owners manual.
		The installer has reviewed all safety instructions with the property owner , including the need to never let children operate or play with gate controls, to keep the remote control away from children, and to always keep people and objects away from the gate.
		The installer has explained to the property owner that a regular maintenance schedule for both the gate and the gate operator is recommended, including regular testing of entrapment protection as outlined in the manufacturer's instructions.
		The installer has left the installation/owners manual with the property owner for future reference.

Alarm Sounding OR "Chirping" and Gate Will NOT Operate

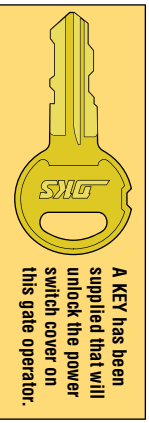

To obtain key to unlock gate operator contact:

Name _____
 Phone # _____

Operator is in a HARD Shutdown Condition: The alarm will sound for (5) five minutes. After five minutes the alarm will start "Chirping" every 5 seconds and continue "Chirping" until operator gets reset.

When Alarm is Sounding OR "Chirping"

ALWAYS CHECK THE ENTIRE GATE AREA FOR ANY OBSTRUCTIONS OR DAMAGE FIRST!

- If a Fire Dept. Access Device has been activated by emergency personnel, then operator can be reset and put back into normal operation again. Alarm will **always** sound when this access device gets activated.
- If the cause of the alarm **CAN** be identified and **CORRECTED**, then operator can be reset and put back into normal operation again.
- If the cause of the alarm **cannot be corrected**, shut-off power and **DO NOT** place this operator back into service until the malfunction can be identified and **CORRECTED**.

IMPORTANT! Putting this gate operator back into service **WITHOUT CORRECTING** the cause of the alarm could result in serious injury or DEATH!

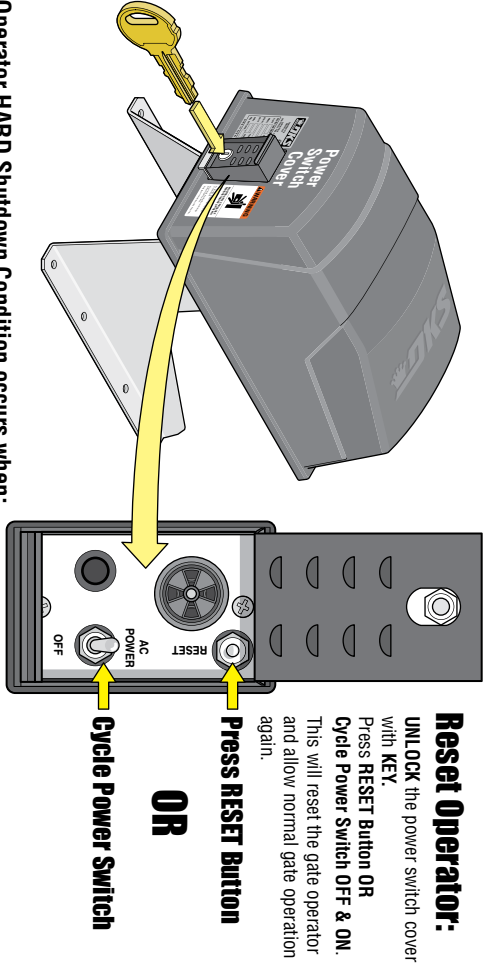

Operator HARD Shutdown Condition occurs when:

1. Fire Department (Emergency Access) input has been activated by Police, Fire Department, EMT, Ambulance etc.
2. The inherent entrapment protection system (Type A) gets activated TWO consecutive times before the gate completes the open cycle OR the close cycle.
3. The reversing edge contact sensor (Type B2) gets activated and reverses, but before the gate completes the reverse cycle the inherent entrapment protection system (Type A) gets activated.

Please read **SECTION 5 - OPERATING INSTRUCTIONS** for more information about operating this gate operator.

Manual Gate Operation

Caution: NEVER attempt to manually operate the gate until you have VERIFIED that ALL power to the gate operator has been SHUT-OFF!

Please read **SECTION 5 - OPERATING INSTRUCTIONS** for more information about operating this gate operator.

FAIL-SAFE Manual Operation

Gate can be IMMEDIATELY manually operated (pushed open) during a power outage. **NO** Key is required.

- For manual FAIL-SAFE gate operation, turn power to the operator OFF. Once power is OFF, the gate can be manually operated.

- 1 Pull the gate crank arm (arm that is attached to the operator shaft) away from the gate so the arms are not in a straight line.
- 2 Go to the end of the gate and pull it open.

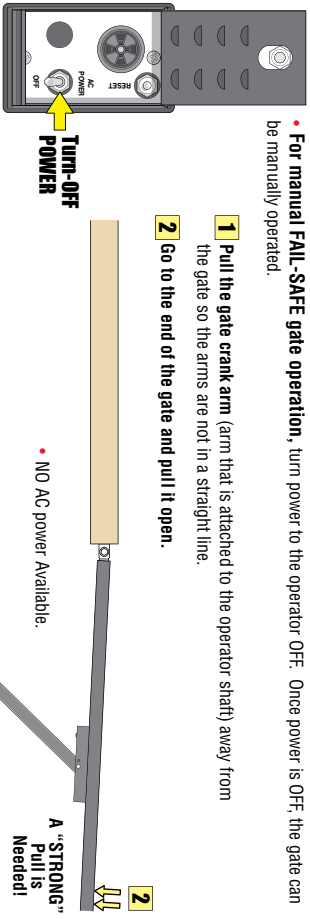

Note: If the Gate Tamper Protect is in use, a forced entry attempt transaction will be sent to the DoorKing access control system at this time.

Manual Release

In addition to FAIL-SAFE manual operation, this operator also employs a locked release pin to place the gate in manual operation when AC power is removed.

- NO AC power.
- Note: The owner of the gate operator is responsible for the padlock KEY availability.

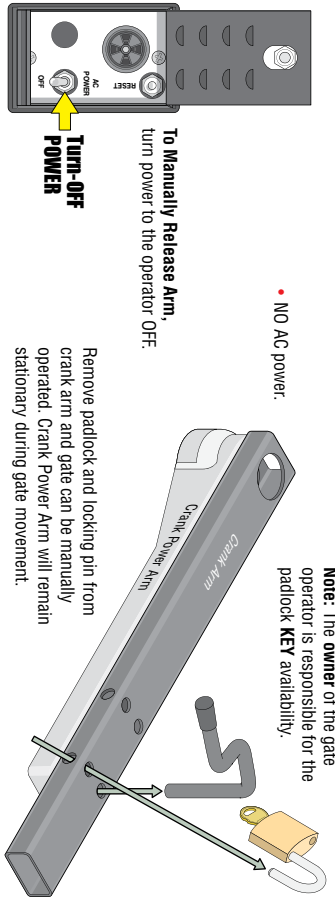

To Manually Release Arm, turn power to the operator OFF.

Turn-OFF POWER

To obtain key to unlock operator arm contact:

Name _____
 Phone # _____

Installation/Owner's Manual

Series 6050 and 6100

Vehicular Swing Gate Operator

Use this manual for circuit board 4502-018 Revision A or higher.

6050-065-X-10-23

Entrapment Protection must be provided for the gate system where the risk of entrapment or obstruction exists. The operator will not run without one or more monitored type B1 or B2 entrapment protection devices in EACH entrapment area.

UL 325 August 2018 Standard



THIS PRODUCT IS TO BE INSTALLED AND SERVICED BY A TRAINED GATE/DOOR SYSTEMS TECHNICIAN ONLY.
Visit www.doorking.com/dealer-locator to find a professional installing and servicing dealer in your area.

www.doorking.com

DoorKing, Inc.
120 S. Glasgow Avenue
Inglewood, California 90301
U.S.A.

Phone: 310-645-0023
Fax: 310-641-1586