

REVISIONS

ZONE	REV.	DESCRIPTION	DATE	APPROVED
	J	Remove 2600-440 Bearing and 2600-453 Holder, Replace with Bearing Assy Kit 2600-466	6/15/2012	D.C.
	K	K Added 9200-190 Resistor Kit UL325 2/1/16 PSK	3/2/2016	DC

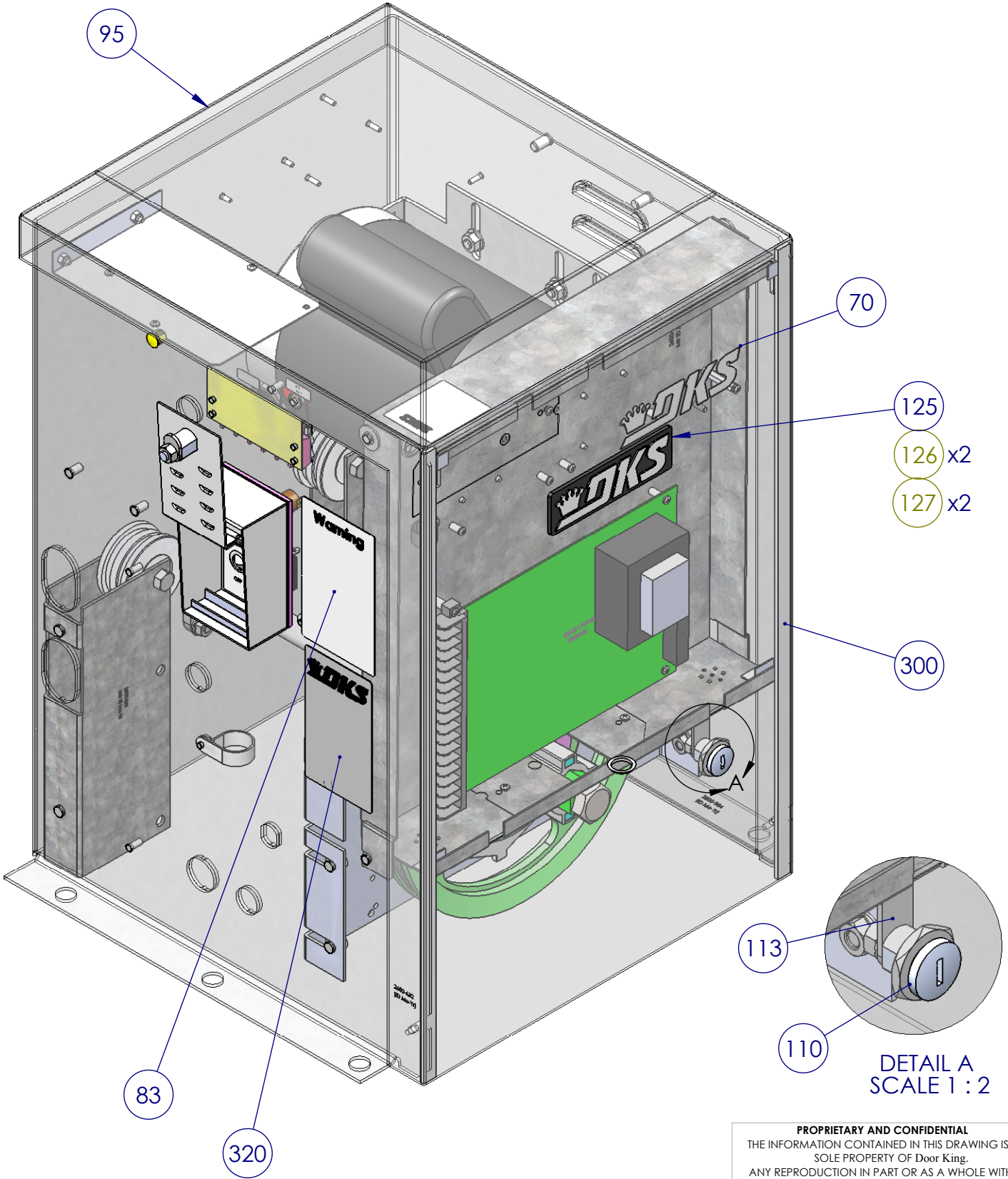

DETAIL A  
SCALE 1 : 2

**PROPRIETARY AND CONFIDENTIAL**  
 THE INFORMATION CONTAINED IN THIS DRAWING IS THE  
 SOLE PROPERTY OF Door King.  
 ANY REPRODUCTION IN PART OR AS A WHOLE WITHOUT  
 THE WRITTEN PERMISSION OF Door King IS PROHIBITED.

**DKS**

Model 9150-080  
 1Hp 115Volt

SIZE <b>A</b>	DWG 9150-880	REV <b>K</b>
SCALE: 1:8		SHEET 1 of 5



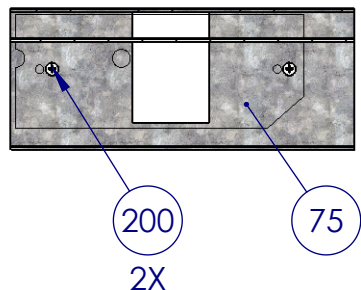
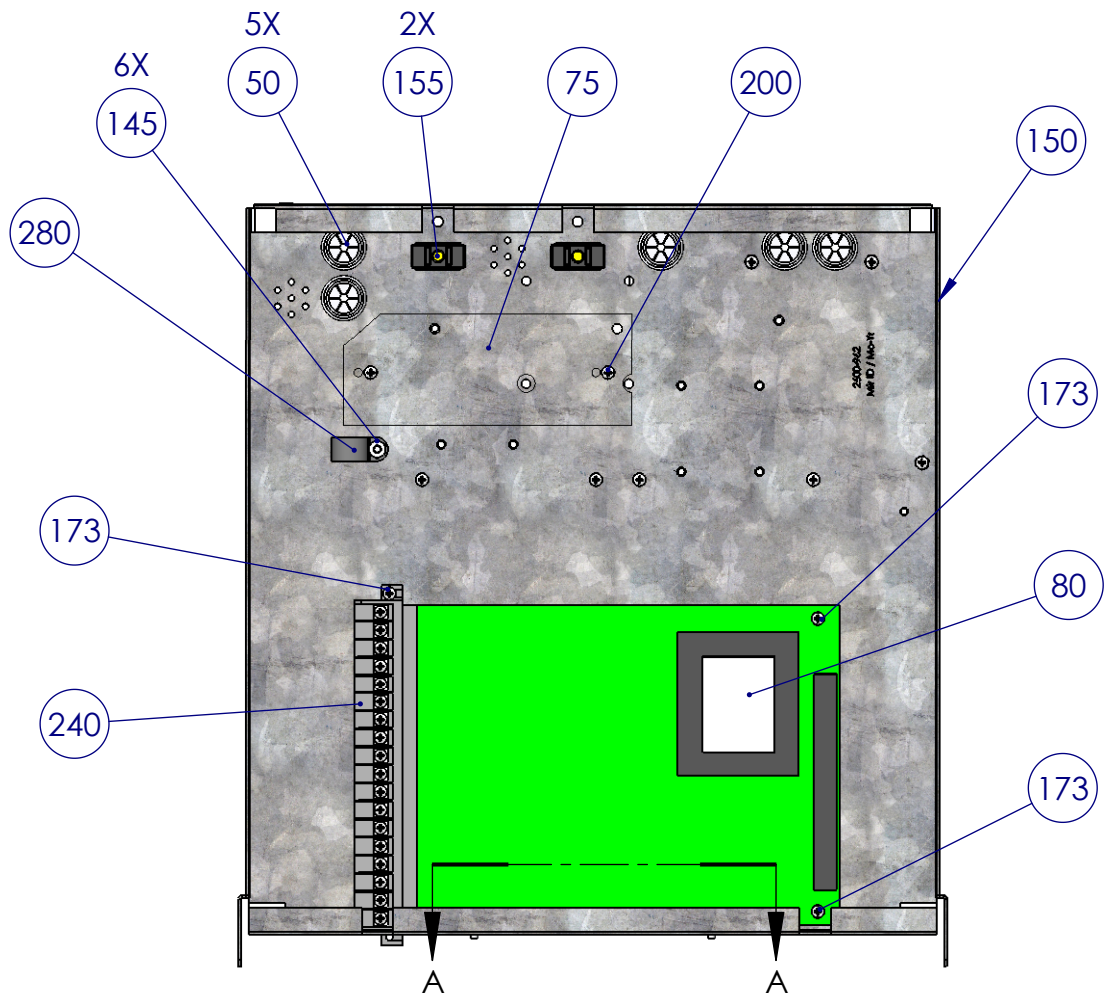

SECTION A-A  
SCALE 1 : 4

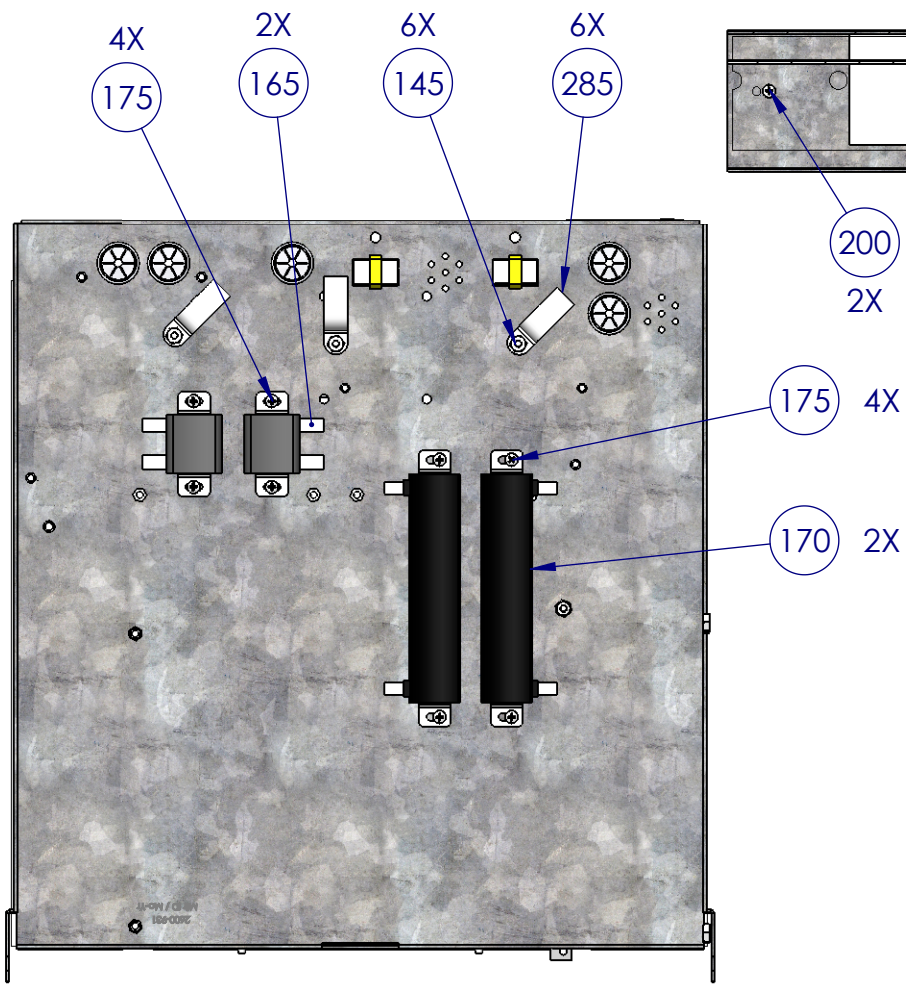

**PROPRIETARY AND CONFIDENTIAL**  
 THE INFORMATION CONTAINED IN THIS DRAWING IS THE  
 SOLE PROPERTY OF Door King.  
 ANY REPRODUCTION IN PART OR AS A WHOLE WITHOUT  
 THE WRITTEN PERMISSION OF Door King IS PROHIBITED.



Model 9150-080  
 1Hp 115Volt

SIZE <b>A</b>	DWG 9150-880	REV <b>K</b>
SCALE: 1:12	SHEET 3 of 5	

ITEM	PART #	U/M	DESCRIPTION
1	9150-065	1 EA	Manual Installation
2	9150-066	1 EA	Manual Quick Start
5	9150-880	1 EA	IPB 9150-080
9	2600-731	1 EA	Gasket Switch Cover
19	2600-466	1 EA	Bearing Assembly Rear 910/915
20	2600-053	1 EA	Bearing - Thrust 3/4 ID
30	2600-694	1 EA	Belt - AX36
35	2600-965	1 EA	Bracket Idler Left 9150
40	2600-966	1 EA	Bracket Idler Right 9150
45	2600-938	1 EA	Radio Tray 9100
50	2600-810	5 EA	Bushing 7/8 Poke Thru Flaps
60	2600-871	2 EA	Bushing 1/2"ODx5/16"IDx1 5/16L
65	2801-004	1 EA	Clutch Pad 5" OD - 3/4" ID
70	9150-006	1 EA	Cover Plastic Model 9150
75	2600-945	2 EA	Cover Plastic Insulator
80	4602-010	1 EA	PCB Slide Gate Operator
83	2599-034	1 EA	Label Gate Operator
87	2615-153	4 EA	Bolt Hex Head 5/16-18 x 3/4
90	2615-155	2 EA	Bolt Hex Head 5/16-18 x 1 3/4
95	2600-932	1 EA	Door Model 9150
100	2600-880	1 EA	Hole Plug Plastic for 3/8 Hole
105	2600-984	1 EA	Housing-Model 9150
110	4001-035	1 EA	Lock N16058BDxSFx2K Key 16120
113	1702-503	1 EA	Cam 1.1/4
115	2600-431	1 EA	Marker Strip Silkscreened
125	2600-732	1 EA	Nameplate Plastic DKS Big
126	2802-040	2 EA	Washer Push on Clamp
127	1897-050	2 EA	Gasket Support Thick 1/16"
135	2902-006	3 EA	Nut Nylon Lock 10-32
140	2620-411	18 EA	Nut Hex Flange Lock 5/16-18
145	2902-003	18 EA	Nut Nylon Lock 6-32
147	2620-409	4 EA	Nut Hex Flange Lock 1/4-20
150	2600-962	1 EA	Mount Plate PC Board Mod 9150
155	1200-028	2 EA	Outlet Snap-In Leviton 1306
160	2600-957	1 EA	Pulley 10 inch Aluminum Assy
165	2600-848	2 EA	Resistor Power 1 ohm 30 Watt
170	2600-847	2 EA	Resistor Power 1 ohm 65 watt
173	2616-003	3 EA	Screw Phillips Head 6-32x3/4SS
175	2616-006	8 EA	Screw Phillips Head 6-32x3/16
180	2616-002	6 EA	Screw Phillips Head 6-32 x 1/2
185	2616-007	3 EA	Screw Phillips Head 6-32x5/8"
190	2616-000	8 EA	Screw Phillips Head 6-32 x 1/4
195	2616-007	2 EA	Screw Phillips Head 6-32x5/8"
197	2616-051	2 EA	Screw Phillips 10-32x3/8
198	2616-052	1 EA	Screw Phillips Head 10-32 x1/2
200	2600-887	4 EA	Screw Nylon Phillips 6-32x1/4"
205	2600-904	1 EA	Main Shaft Assembly

			
Model 9150-080 1HP 115V			
SIZE	DWG	REV	
<b>A</b>		<b>K</b>	9150-880
SCALE:1:12		SHEET 4 of 5	

(Cont.)

ITEM	PART #	U/M	DESCRIPTION
210	2600-931	1 EA	Bracket Shaft Support 915
215	2600-860	1 EA	Solenoid Lock Assy 91XX
220	2600-446	1 EA	Spring-Compression
234	2600-487	1 EA	Bracket Solenoid Support
235	1601-041	1 EA	Switch Toggle SPST 2POS
236	1506-071	1 EA	Tone Generator Loud
237	1812-005	1 EA	Switch Push Button N.O.
240	2901-002	1 EA	Terminal 18 Pin
245	2600-886	2 EA	Idler Wheel UHMW
250	2600-840	2 EA	Jumper- Ring Tongue #8 Screw
255	3130-008	1 EA	Terminal Block 5 pin
257	3129-005	1 EA	Terminal Block Cover 5 Positio
260	2600-439	1 EA	Washer Cup - Brass
261	2620-028	6 EA	Washer 5/16" USS
265	2600-344	1 EA	Washer 1 1/8"OD x 3/4"ID
266	2600-990	1 EA	Washer Neoprene 1.5"x.725"x125
270	2600-345	1 EA	Washer Hardened 1 1/4 x 3/4 ID
273	2620-035	1 EA	Washer 4"ODx3/4"ID
275	2620-053	2 EA	Lockwasher 5/16"
280	2600-619	7 EA	Wire Clp-5/8" Concord 770-1209
283	2600-987	1 EA	Wire Set 9150 Operator 1HP
285	2600-639	6 EA	Wire Clamp-1"
295	1804-031	15 EA	Tie Wrap 4"
297	2600-749	2 EA	Wire Connector STA-KON RC6
300	4001-018	7 FT	Weather Stripping 50' rolls
310	2599-008	1 EA	Label Patent
315	2599-006	1 EA	Decal SUPPLY GND
320	2599-199	1 EA	Label Universal
335	2599-014	1 EA	Decal Copper Wire Only
340	2599-100	2 EA	Sign Warning
345	4001-093	1 EA	MOV Assembly 130VAC
346	9200-190	1 EA	Resistor Kit UL325
500	2600-162	1 EA	Motor Assy 1HP Model 6300-9150
510	2600-852	1 EA	Accessory Box 9150 Operator
520	2600-533	1 EA	Switch Cover Doorking Lockable
530	2600-917	1 EA	Jam Nut Magnet Subassy 910/915

			
Model 9150-080 1HP 115V			
SIZE	DWG	REV	
<b>A</b>		<b>K</b>	
SCALE:1:12			SHEET 5 of 5