

QUICKSTART "BASIC" GUIDELINES FOR MODEL 6300 - FOR GATES UP TO 18 FEET AND OPENING 90°

UL 325 August
2018 Standard



120 S. Glasgow Avenue
Inglewood, California 90301
U.S.A.

Model 6300 is intended for installation only on swing gates used for vehicles. Pedestrians must be supplied with a separate access opening.

For safety and installation instructions, please refer to the Installation/Owner's manual.

Operator Position

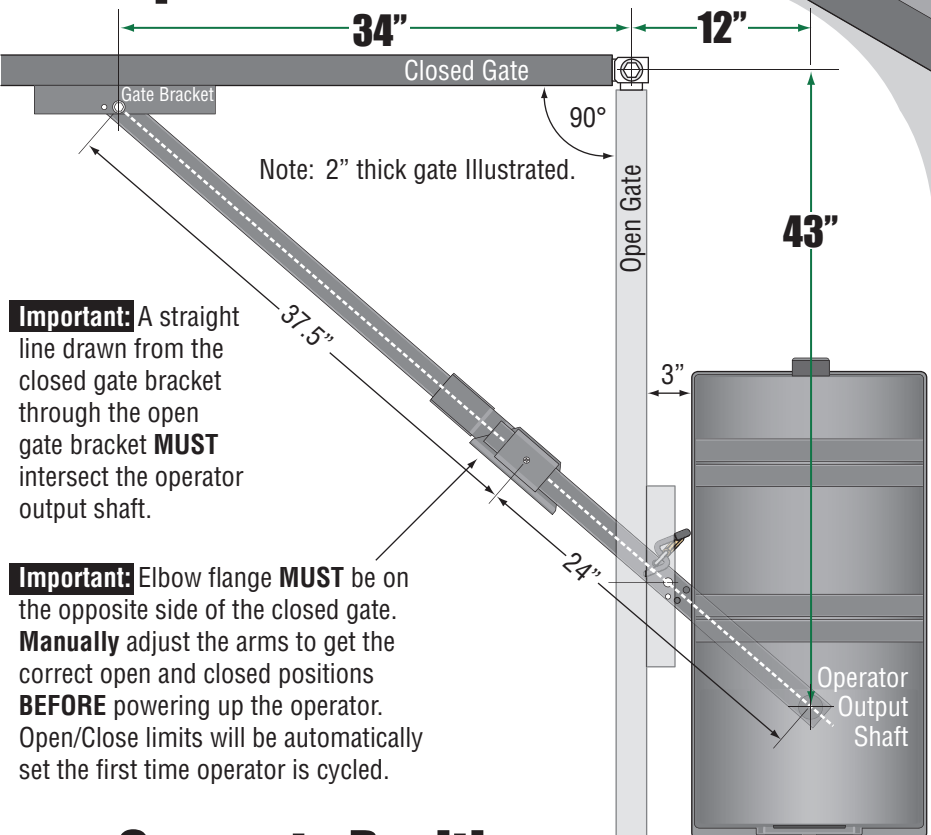

Concrete Position

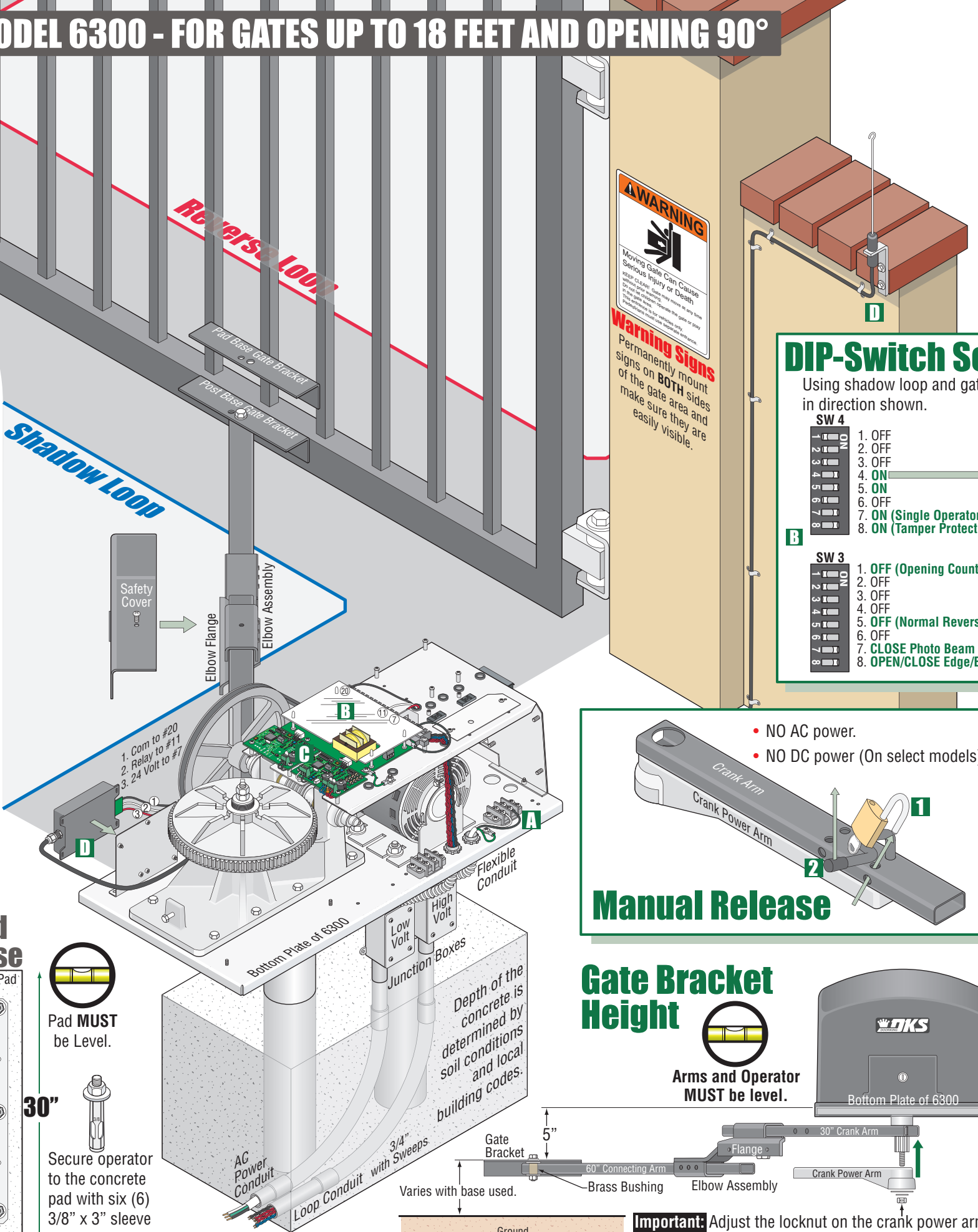
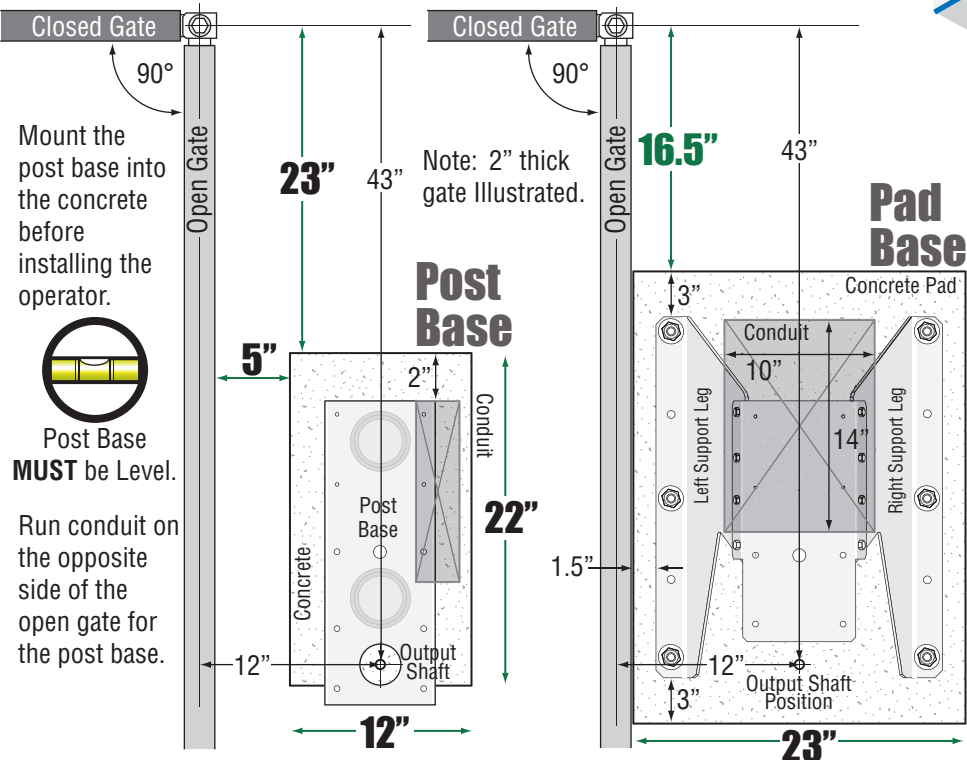

DIP-Switch Settings

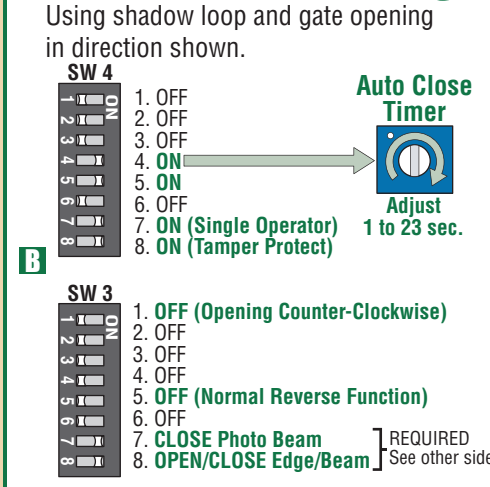

High Voltage Connection

GATE OPERATOR MUST BE PROPERLY GROUNDING!

Tip: It is recommended that a surge suppressor be installed on the high voltage power lines.



Important: The elbow assembly must be in the correct position on the arms **BEFORE** cycling operator the first time.

High Voltage Conduit

Note: "Optional" High Voltage Kit black and white wires connect the same as shown. See High Voltage Kit instruction sheet for more information.

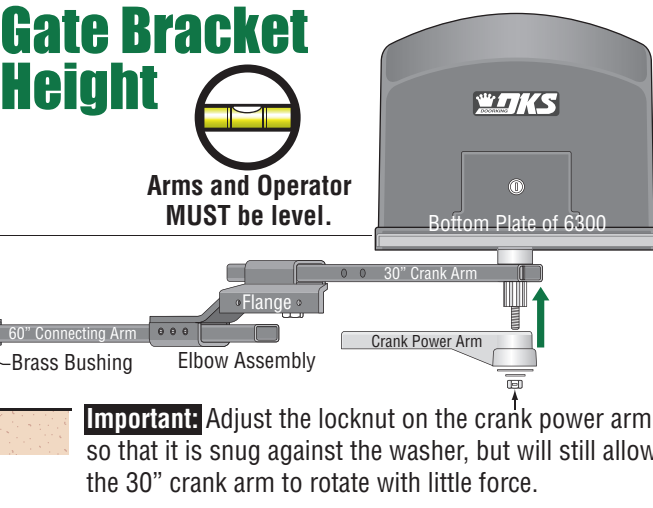
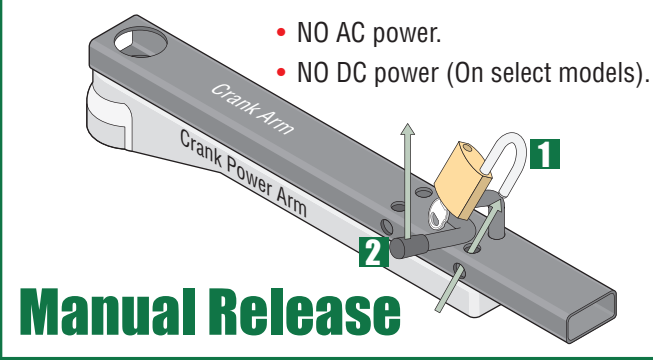

Loop Detectors

C Not included - Refer to the Installation/Owner's manual and Loop Information Manual (available **FREE** from www.doorking.com) for more information on loops and loop detectors.

Radio Receiver

D Not included - Refer to a specific Radio Receiver Manual (available from www.doorking.com) for more information on radio receivers and antenna installation. (See reverse side for wiring)

Entrapment Protection must be provided for the gate system where the risk of entrapment or obstruction exists. The operator will not run without one or more monitored type B1 or B2 entrapment protection devices in EACH entrapment area.

QUICKSTART "BASIC" GUIDELINES FOR MODEL 6300 - DIP-SWITCH AND WIRING REFERENCE

UL 325 August
2018 Standard



120 S. Glasgow Avenue
Inglewood, California 90301
U.S.A.

Model 6300 is intended for installation only on swing gates used for vehicles.
Pedestrians must be supplied with a separate access opening.

For safety and installation instructions, please refer to the Installation/Owner's manual.

! Every time the operator is powered up, the First open command will automatically set the open and close limits of the gate.

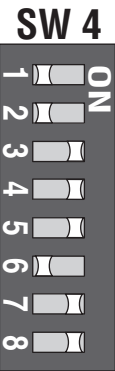

SW 4 (Top 8 Switches)				
Switch	Function	Setting	Description	
1 and 2	Circuit Board Relay	1-OFF 2-OFF	Relay activates when gate is open (Shadow loop setting when used).	
		1-OFF 2-ON	Relay activates when gate is not closed.	
		1-ON 2-OFF	Relay activates when gate is opening and open.	
		1-ON 2-ON	Relay activates when gate is opening and closing.	
3	Exit Loop Port Output	OFF	The output wired to terminal #12 becomes the output from the exit loop detector plugged into the EXIT Loop port.	
	Full Open Input	ON	Normal Setting. Terminal #12 is a normal full open input.	
4	Auto-Close Timer	OFF	Auto-close timer is OFF. Manual input required to close gate.	
		ON	Auto-close timer is ON. Adjustable from 1-23 seconds to close gate.	
5	Slide Operator	OFF	Switch must be OFF for slide gate operator (DO NOT use for 6300).	
	Swing Operator	ON	Normal Setting. Switch must be ON for swing gate operator.	
6	3-Button	OFF	OFF when using a 3-button station (DoorKing 3-button control stations only).	
	Single Button	ON	ON when using a single button control, terminals 13 & 14 become a STOP input.	
7	Dual Operators	OFF	Switch must be OFF when bi-parting (dual) gates are used.	
	Single Operator	ON	Switch must be ON for single operator.	
8	Tamper Protect	OFF	Tamper protect is OFF.	
		ON	Normal Setting. Tamper protect is ON. Operator will close gate when being forced open.	

Note: After a DIP-switch setting is changed, power must be turned OFF and then turned back on for the new setting to take affect.

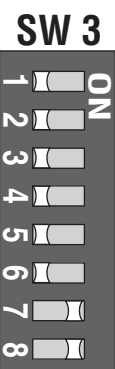

SW 3 (Bottom 8 Switches)				
Switch	Function	Setting	Description	
1	Primary 6300 Gate Opening Direction	Opens Clockwise	Opens Clockwise	
		Opens Counter-Clockwise	Opens Counter-Clockwise	
2	Secondary 6300 Gate Opening Direction	Same as above, for secondary 6300 ONLY.		
3	Self-Test	OFF	Normal Setting. Normal operation.	
		ON	Self-test mode. Operator MUST be disconnected from gate to run self test.	
4	Single Gates OR Bi-Parting Gates	OFF	Switch is OFF when using a single operator.	
		ON	Switch is ON when using dual gate operators (Primary/Secondary Bi-Parting gates).	
5	Reverse	OFF	Terminal 15 is a STANDARD Reverse input.	
	Shadow Loop	ON	Terminal 15 is a Shadow input. Gate will NOT stop during the close cycle.	
6	Gate Overlap	OFF	Primary and secondary operators start at the same time.	
		ON	Secondary operator starts 1-2 seconds prior to primary operator.	
7	Monitored Close Beam	OFF	No Photo Sensor connected to Aux terminal 7 and 8.	
		ON	Photo sensor is connected to Aux terminal 7 and 8 and monitored. (Close ONLY)	
8	Monitored Edge/Beam	OFF	No Edge or Beam connected to Aux terminal 9 and 10.	
		ON	Edge OR Beam is connected to Aux terminal 9 and 10 and monitored. (Open/Close)	

