

## Solar Powered

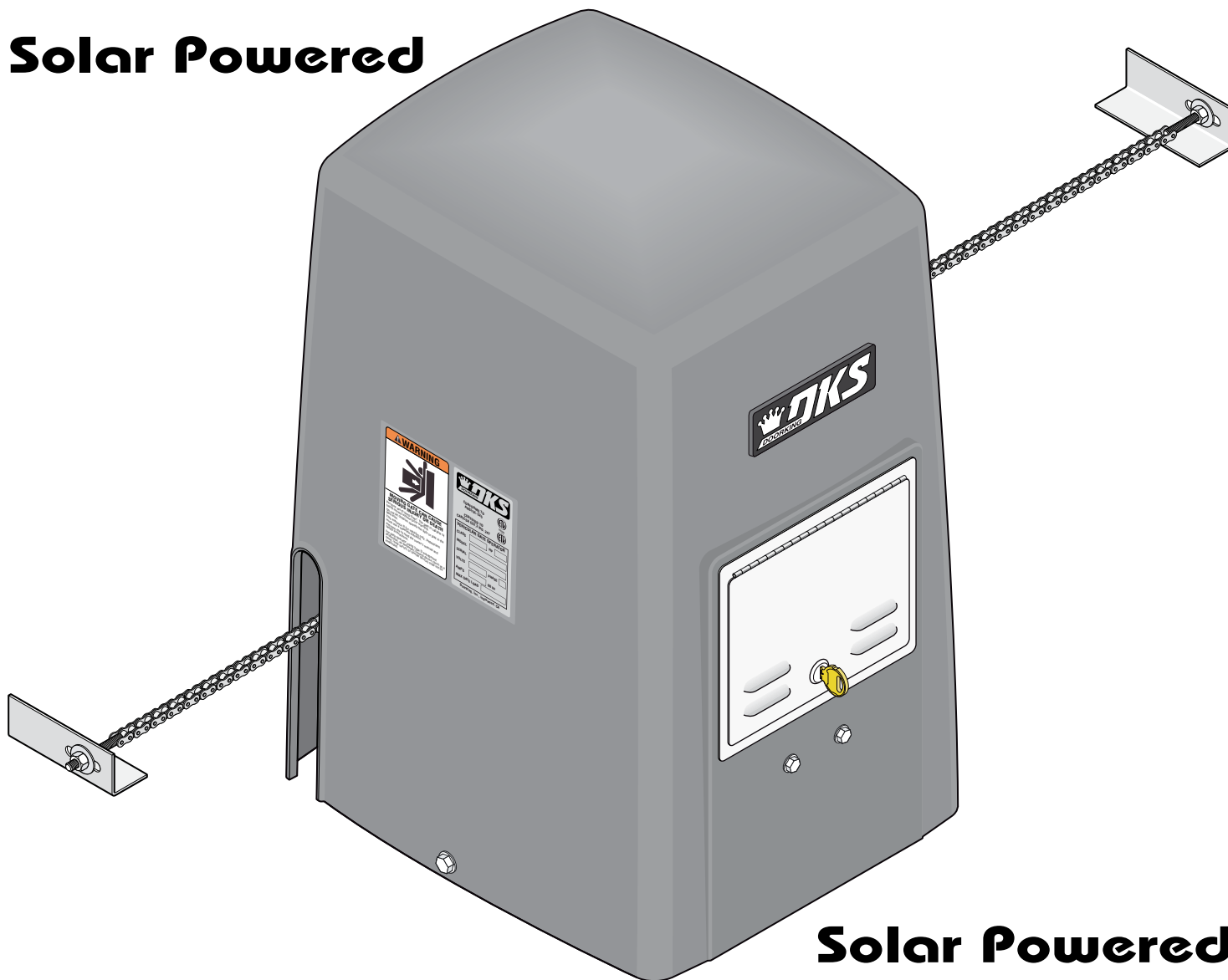

## Solar Powered

Date Installed: \_\_\_\_\_

Installer/Company Name: \_\_\_\_\_

\_\_\_\_\_

Phone Number: \_\_\_\_\_

Circuit Board  
Serial Number  
and Revision Letter: \_\_\_\_\_

**Leave Manual with Owner**

Copyright 2015 DoorKing, Inc. All rights reserved.



UL 325 Compliant





# QUICK GUIDE: DIP-Switches

See page 24 for more information about DIP-switches.



Reset button on circuit board **MUST** be pressed before new DIP-switch settings will take affect.

SW 1 (Top 8 DIP Switches)			
Switch	Function	Setting	Description
1	Operator Opening Direction	Opening direction using <b>ON</b> setting.    Opening direction using <b>OFF</b> setting.	Changes direction operator will cycle open upon initial AC power up and open command.
2	Auto-Close Timer	OFF	Auto-close timer is <b>OFF</b> . Manual input required to close an open gate.
		<b>ON</b>	<b>Normal Setting.</b> Auto-close timer is <b>ON</b> . Adjustable from 1-23 seconds.
3	Not Used	<b>OFF</b>	Switch <b>MUST</b> be turned <b>OFF</b> for Solar.
4	Reverses Gate	<b>OFF</b>	<b>Normal Setting.</b> Input to main terminal 10 and reverse loop will <b>reverse</b> gate during <b>close</b> cycle.
	Stops Gate (Slide gates)	ON	Input to main terminal 10 and/or reverse loop will <b>stop</b> gate during <b>close</b> cycle – gate will <b>continue to close</b> after input to main terminal 10 and/or reverse loop are cleared (Helps prevent tailgating).
5	Quick-Close Timer Override (Slide gates)	<b>OFF</b>	<b>Normal Setting.</b> Quick close feature is <b>OFF</b> . Auto-Close timer functions normally.
		ON	Quick close feature is <b>ON</b> . Opening gate will stop and close as soon as all reversing inputs (Reverse loops, photo sensors) are cleared regardless of the distance the gate has opened. Any Auto-Close timer setting overrides to 1 sec.
6 and 7	Relay: Main Terminals 13 and 14	6-OFF 7-OFF	<b>Normal Setting.</b> Relay activates when gate is at open limit.
		6-OFF 7-ON	Relay activates when gate is not closed.
		6-ON 7-OFF	Relay activates when gate is opening and open.
		6-ON 7-ON	Relay activates during opening and closing cycle.
8	Accessory Power	<b>OFF</b>	24 VDC 500 mA <b>Constant power</b> for accessories connected to main terminal 12.
		ON	<b>DO NOT USE</b> for Solar.

 Setting **MUST** be used

SW 2 (Bottom 8 DIP Switches)			
Switch	Function	Setting	Description
1 and 2	Select Operator Type	<b>1-OFF 2-OFF</b>	<b>Slide Gate Operator</b>
		1-OFF 2-ON	<b>DO NOT USE</b> for the 9024. Swing Gate Operator
		1-ON 2-OFF	<b>DO NOT USE</b> for the 9024. Barrier Gate Operator
		1-ON 2-ON	<b>DO NOT USE</b> for the 9024. Overhead Gate Operator
3	Input Power Failure Mode	<b>OFF</b>	Gate <b>operates normally</b> using <b>ONLY</b> battery back-up power or <b>Solar input power</b> .
		ON	<b>DO NOT USE</b> for Solar. Gate <b>fully opens/shuts down until AC power</b> is restored.
4	Reverse/Shadow Input	<b>OFF</b>	Main terminal 10 is a REVERSE input.
		ON	<b>DO NOT USE</b> for the 9024. Main terminal 10 is a SHADOW loop (Swing gates ONLY)
5	Overlapping Dual Gates	<b>OFF</b>	Switch 5 <b>MUST</b> be turned <b>OFF</b> for the 9024.
		ON	<b>DO NOT USE</b> for the 9024. Overlapping gates <b>ARE</b> used (Dual swing gates ONLY). Secondary gate starts to open a few seconds before primary gate starts.
6	Circuit Board Power Management	OFF	<b>DO NOT USE</b> for Solar. For 115/230 VAC input power. Board has <b>Constant power</b> .
		<b>ON</b>	Used for <b>Solar</b> input power. Board <b>Minimizes power</b> when not in use. All terminals shut down power except <b>main terminals 1, 2, 3</b> and <b>loop detector ports</b> .
7 and 8	Not Used	<b>OFF</b>	Switches 7 and 8 <b>MUST</b> be turned <b>OFF</b> for the 9024.

See page 25 for terminal wiring.

# QUICK GUIDE: Terminal Descriptions

## UL 325 Terminal

**UL 325**  
See pages 27 - 29

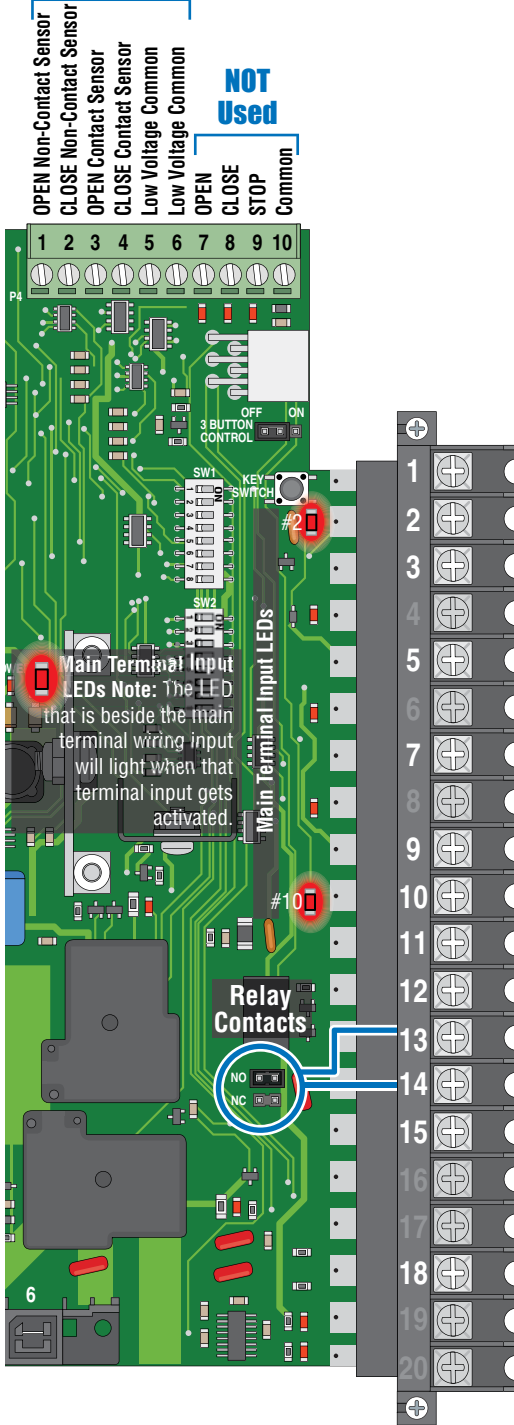

## 20-Pin Main Terminal

Terminals 1, 2 and 3 are ALWAYS powered up. Even when circuit board has powered down to manage the power drain on the batteries.  
**ONLY** connect **opening devices** to terminal 2.

This input **ONLY** functions when gate is **fully opened** or in the **closing cycle**.

- When gate is closing: SW 1, **switch 4** is **OFF**, an input to main terminal 10 (eg: photo beam gets obstructed) will **reverse** and open the gate. **Note:** If the auto-close timer is ON, when gate reaches the open position, timer will time out and close the gate.
- When gate is closing: SW 1, **switch 4** is **ON**, an input to main terminal 10 (eg: photo beam gets obstructed) will **stop** the gate, then continue to close the gate when input is clear (Used to help prevent tailgating vehicles from unauthorized entry). See page 24 for more information.

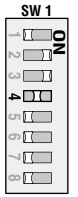

SW1, **switch 8** **MUST** be **OFF**: 24-VDC 500 mA constant power can be provided for desired accessories wired to terminal 12.  
**DO NOT** turn ON SW1, switch 8.

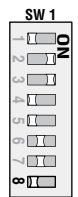
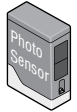

Operation of relay is dependent on setting of SW 1, **switches 6 and 7**. **Relay contacts** can be set for Normally Open (NO) or Normally Closed (NC) operation.  
**Contact rating is 1 amp maximum at 24-volts DC.**

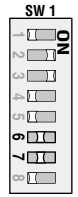
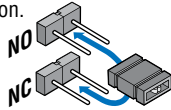

# SPECIFICATIONS FOR MODEL 9024-081

Use this manual for the Model 9024-081 operator with circuit board 4100-010 Rev D or higher ONLY.

<b>Class of Operation</b>	UL 325 Class I, II, III, IV
<b>Type of Gate</b>	Vehicular Slide Gates Only
<b>Drive Sprocket Size</b>	#40 Chain
<b>Motor</b>	Quadra Drive DC Motor
<b>Power Input: Volts@Amps</b>	24 VDC @ 8 Amps
<b>Batteries</b>	None Included (24 VDC Output Required)
<b>Maximum Gate Cycles</b>	DKS Solar Power Kit: Solar Panel Power - Continuous DKS Solar Power Kit: ONLY Battery Power - 150+ Cycles Unknown when using Third Party Solar Power Setup

**Battery Power Note:** The number of gate cycles when using ONLY battery power WILL vary depending on gate weight, gate length, operating condition of gate hardware, temperature and amount of charge in batteries.

<b>Gate Speed</b>	1 Ft/Sec
<b>Max Gate Weight</b>	1,000 Lbs - 453.6 Kg (Gate installed level in good working condition)
<b>Max Gate Length</b>	40 Ft - 12.2 Meters (Gate installed level in good working condition)
<b>Entrapment Protection</b>	<b>Primary</b> - Inherent entrapment sensing system (Type A) <b>Secondary</b> - Provision for connection of photo sensors (Type B1) and/or reversing edges (Type B2).

**OPTIONAL DKS Solar Power Kit**  
**Recommended**  
**Two 12 Volt 18 Amp/Hr Batteries**  
**One 24 VDC Solar Panel**  
P/N XXXX-XXX

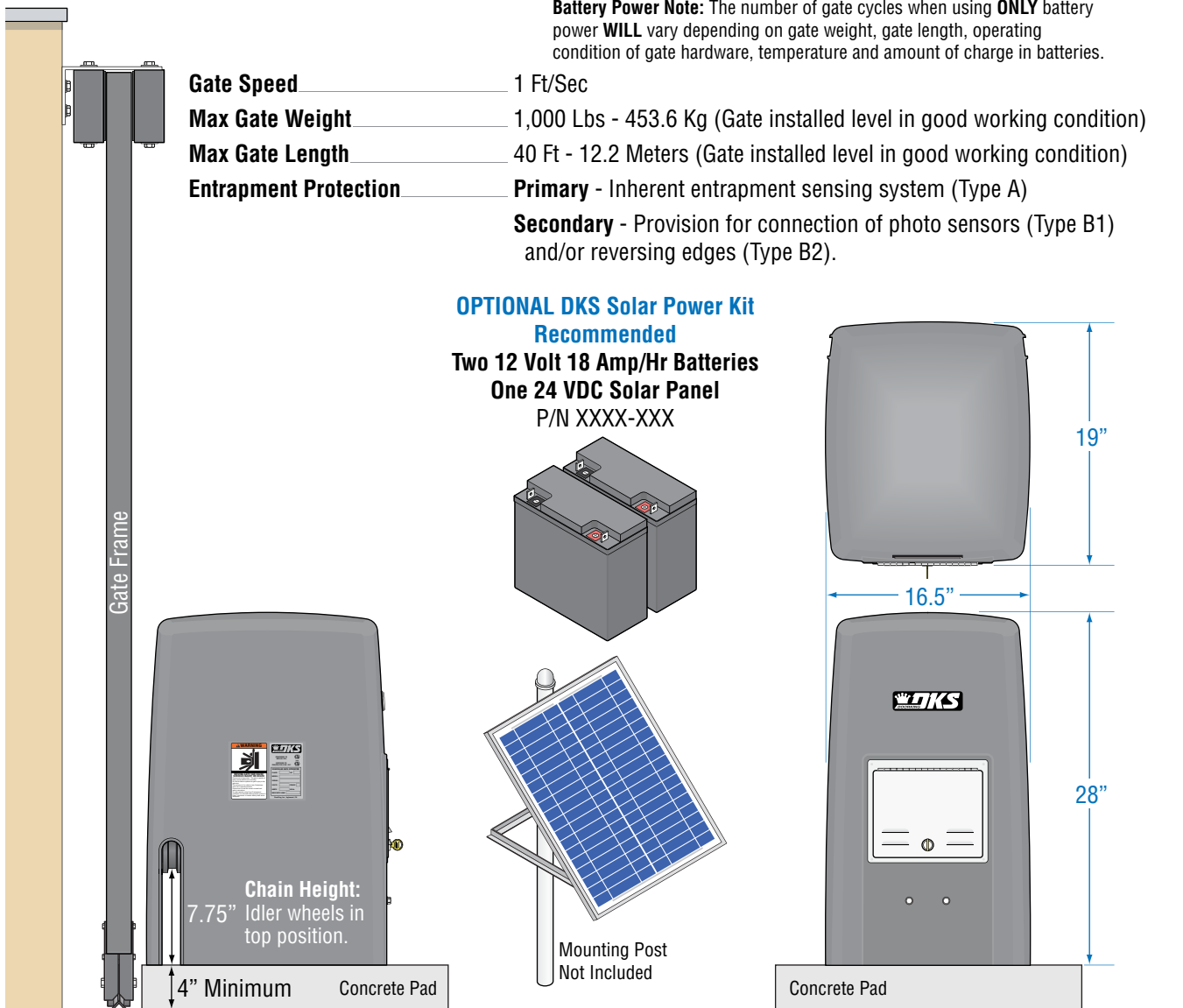

DoorKing, Inc. reserves the right to make changes in the products described in this manual without notice and without obligation of DoorKing, Inc. to notify any persons of any such revisions or changes. Additionally, DoorKing, Inc. makes no representations or warranties with respect to this manual. This manual is copyrighted, all rights reserved. No portion of this manual may be copied, reproduced, translated, or reduced to any electronic medium without prior written consent from DoorKing, Inc.

# TABLE OF CONTENTS

## QUICK GUIDES

Quick Guide: DIP-Switches	Quick Guide - 1
Quick Guide: Terminal Descriptions	Quick Guide - 2

## SPECIFICATIONS FOR MODEL 9024-081 1

Slide Gate Requirements	3
Safety Information for Slide Gate Operators	4
ASTM 2200 Standard for Gate Construction	5
Important Safety Instructions	5
Instructions regarding intended installation	5
Important Notices	6
UL325 Entrapment Protection	7
Glossary	8

## SECTION 1 - INSTALLATION 9

1.1 Hardware for the Gate	9
1.2 Underground Conduit Requirements	9
1.3 Typical Gate Types	10
1.4 Concerns BEFORE Solar Panel Installation	11
1.5 Solar Panel Positioning	12
1.6 Operator Mounting Positions	13-15
1.7 Concrete Pad Setup or Optional Post Mount Kit	16
1.8 Positioning Operator and Chain	17
1.9 Attaching Operator and Chain	17
1.10 Endless Idler Assembly (On Select Installations)	18
1.11 DoorKing's Chain Tray Kit	19
1.12 Installation of Warning Signs	19

## SECTION 2 - SOLAR INPUT POWER TO OPERATOR 20

2.1 Solar Power Connections	20
2.2 Power Select Jumper and Turning Power ON	21

## SECTION 3 - ADJUSTMENTS 22

3.1 4100 Circuit Board Descriptions and Adjustments	22
3.2 DIP-Switch Settings for 4100 Circuit Board	23-24
3.3 Limit Switches	25
3.4 Inherent Reverse Sensor Adjustment	26

## SECTION 4 - ENTRAPMENT AND SAFETY PROTECTION 27

4.1 UL 325 Terminal Wiring	27
4.2 Secondary Entrapment Protection Device Locations	28-29
4.3 Loop Detectors	30

## SECTION 5 - MAIN TERMINAL WIRING 31

5.1 Terminal Descriptions	31
5.2 Control Wiring	32

## SECTION 6 - OPERATING INSTRUCTIONS 33

6.1 Operator Controls and Resets	33
6.2 Shutdown Conditions	34
6.3 Manual Gate Operation	35

## SECTION 7 - MAINTENANCE AND TROUBLESHOOTING 36

7.1 Maintenance	36
7.2 Built-In Diagnostics	36
7.3 Troubleshooting	37-38
7.4 Accessory Items	39
Model 9024-081 Solar Input Power Wiring Diagram	40

# Slide Gate Requirements

**The operator is intended for installation only on gates used for vehicles.** Pedestrians must be supplied with a separate access opening. The pedestrian access opening shall be designed to promote pedestrian usage. Locate the gate such that persons will not come in contact with the vehicular gate during the entire path of travel of the vehicular gate. (ref. UL 325 58.8.4.b)

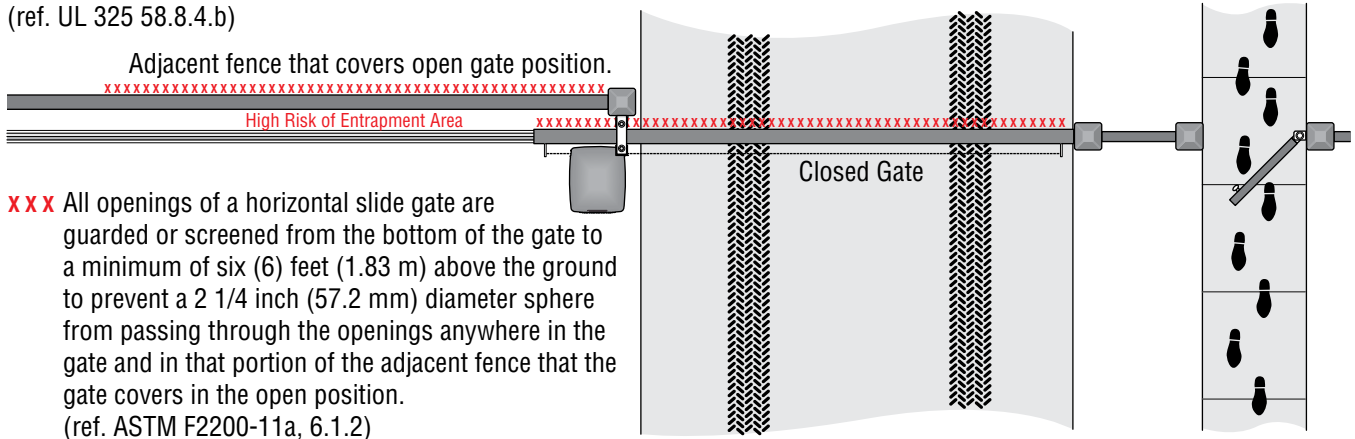

XXX All openings of a horizontal slide gate are guarded or screened from the bottom of the gate to a minimum of six (6) feet (1.83 m) above the ground to prevent a 2 1/4 inch (57.2 mm) diameter sphere from passing through the openings anywhere in the gate and in that portion of the adjacent fence that the gate covers in the open position. (ref. ASTM F2200-11a, 6.1.2)

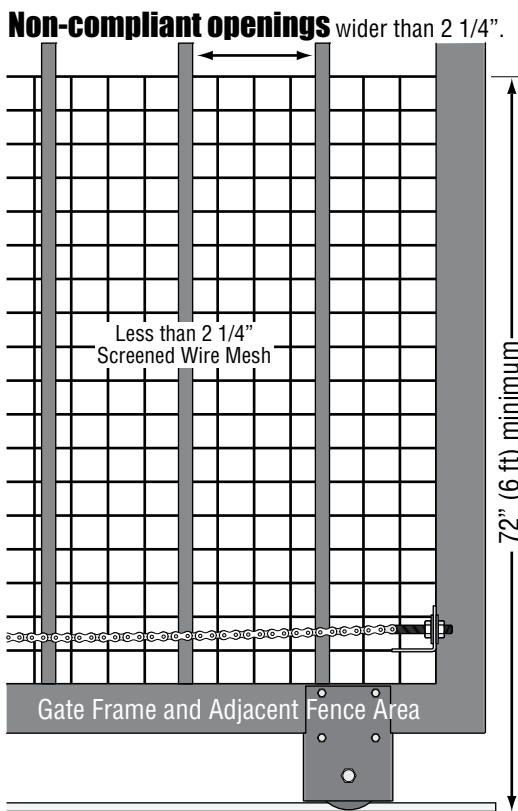
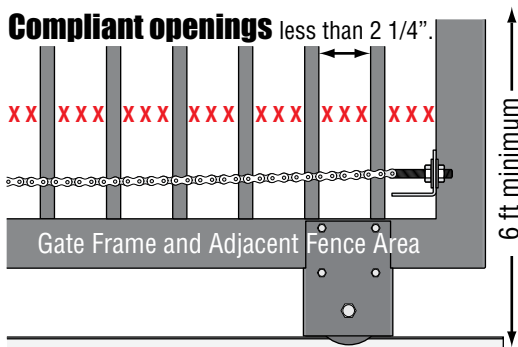

Note: Install screened wire mesh to a non-compliant gate **AND** non-compliant adjacent fence that covers open gate position (See above).

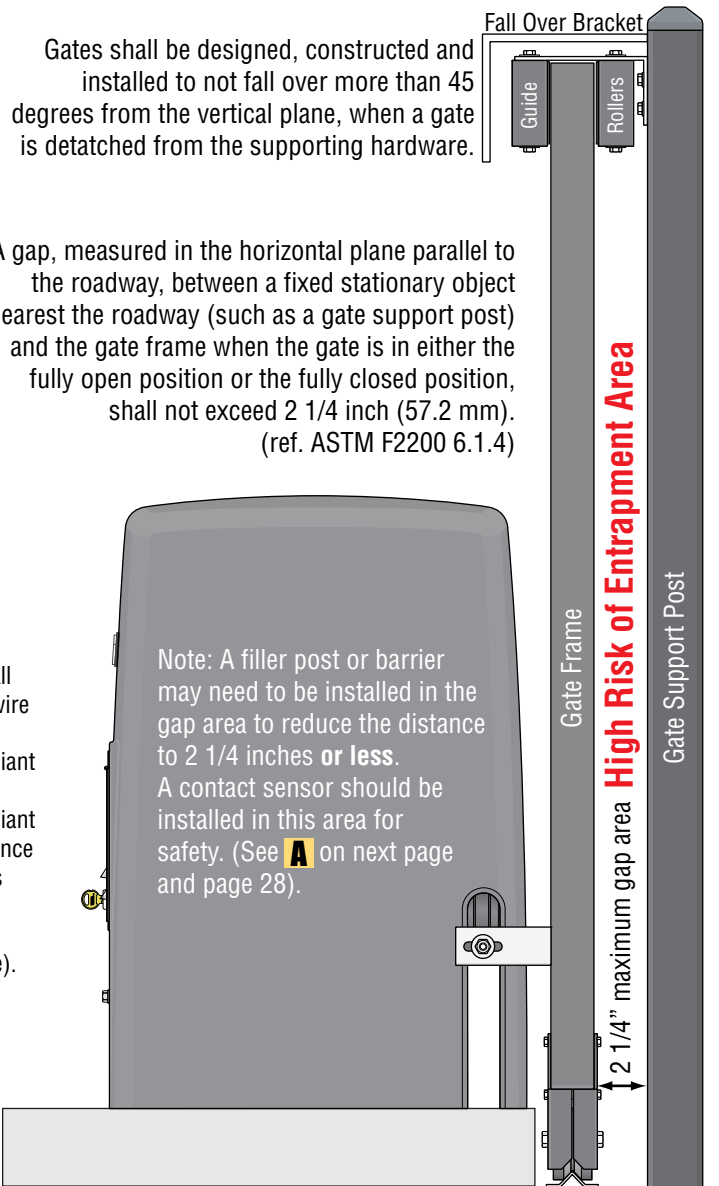

Gates shall be designed, constructed and installed to not fall over more than 45 degrees from the vertical plane, when a gate is detached from the supporting hardware.

A gap, measured in the horizontal plane parallel to the roadway, between a fixed stationary object nearest the roadway (such as a gate support post) and the gate frame when the gate is in either the fully open position or the fully closed position, shall not exceed 2 1/4 inch (57.2 mm). (ref. ASTM F2200 6.1.4)

Note: A filler post or barrier may need to be installed in the gap area to reduce the distance to 2 1/4 inches **or less**. A contact sensor should be installed in this area for safety. (See **A** on next page and page 28).

# Safety Information for Slide Gate Operators

Illustration not to scale.

Entrapment protection devices are required to reduce the risk of injury. Install sensors where the risk of entrapment or obstruction exists while gate is moving. **Individual requirements will vary.** See pages 27-29 for more information on typical layout locations and setup.

## Non-Contact Sensors (Photo Sensors)

- 1** Minimizes the potential of the gate closing on vehicular or other traffic that loops cannot sense. It can be installed on the secure **OR** non-secure side of gate.
- 2** Helps minimize the potential of entrapment during the back travel of the gate.

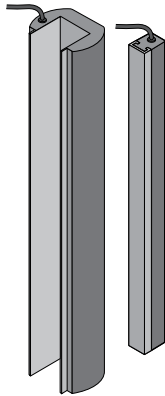

## Contact Sensor (Reversing Edges)

- A** Installed on the fence to help minimize the potential of entrapment between the gate and fence. A filler post or barrier **MAY** need to be installed between fence and gate.
- B** Helps minimize the potential of entrapment during the back travel of the gate.
- C** Minimizes the potential of the gate closing on vehicular or other traffic that loops cannot sense.

## Guide Rollers

See previous page for more information.

## Physical Stops

Positive stops shall be required to limit travel to the designed fully open and fully closed positions. These stops shall be installed either at the top of the gate, or at the bottom of the gate where such stops shall horizontally or vertically project no more than is required to perform their intended function.

## Screened Wire Mesh

May be necessary on part of fence **AND** entire gate. See previous page for more information.

## Warning Sign



## Automatic Exit Loop

(Optional) will provide an open command to the gate operator(s) when a vehicle is exiting the property.

Secure Side of Gate

## Reverse Loop

Minimizes the potential of the gate closing when a vehicle is present. Number and placement of loops is dependent on the application.

## Reverse Loop

Minimizes the potential of the gate closing when a vehicle is present. Number and placement of loops is dependent on the application.

Non-Secure Side of Gate

## Warning Signs

Permanently mounted and easily visible from either side of the gate.



## Separate Pedestrian Walkway

Located so pedestrians cannot come in contact with the vehicular gate.

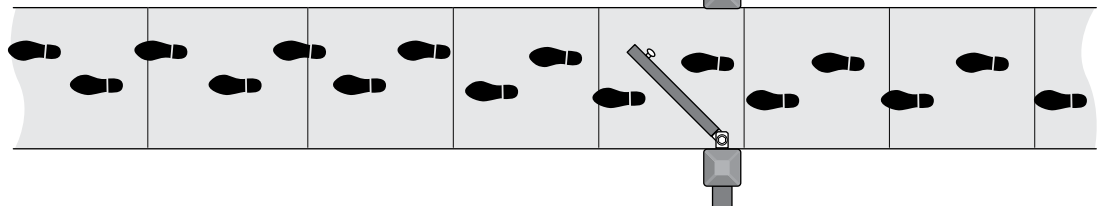

## Physical Stop



# ASTM F2200 Standard for Gate Construction

Vehicular gates should be constructed and installed in accordance with ASTM F2200; Standard Specification for Automated Vehicular Gate Construction. For a copy of this standard, contact ASTM directly at 610-832-9585; [service@astm.org](mailto:service@astm.org); or [www.astm.org](http://www.astm.org).

## Important Safety Instructions

### **WARNING - To reduce the risk of injury or death:**

1. READ AND FOLLOW ALL INSTRUCTIONS.
2. Never let children operate or play with gate controls. Keep the remote control away from children.
3. Always keep people and objects away from gate. **NO ONE SHOULD CROSS THE PATH OF THE MOVING GATE.**
4. Test the operator monthly. The gate **MUST** reverse on contact with a rigid object or stop or reverse when an object activates the non-contact sensors. After adjusting the force or the limit of travel, retest the gate operator. Failure to adjust and retest the gate operator properly can increase the risk of injury or death.
5. Use the emergency release only when the gate is not moving.
6. **KEEP GATES PROPERLY MAINTAINED.** Read the owner's manual. Have a qualified service person make repairs to gate hardware.
7. The entrance is for vehicles only. Pedestrians must use separate entrance.
8. **SAVE THESE INSTRUCTIONS!**

## Instructions regarding intended installation:

- Install the gate operator only if:
  1. The operator is appropriate for the construction of the gate and the usage class of the gate.
  2. All openings of a horizontal slide gate are guarded or screened from the bottom of the gate to a minimum of 6 feet (1.83 m) above the ground to prevent a 2 ¼ inch (57.2 mm) diameter sphere from passing through the openings anywhere in the gate, and in that portion of the adjacent fence that the gate covers in the open position.
  3. All exposed pinch points are eliminated or guarded.
  4. Guarding is supplied for exposed rollers.
- The operator is intended for installation only on gates used for vehicles. Pedestrians must be supplied with a separate access opening. The pedestrian access opening shall be designed to promote pedestrian usage. Locate the gate such that persons will not come in contact with the vehicular gate during the entire path of travel of the vehicular gate.
- The gate must be installed in a location so that enough clearance is supplied between the gate and adjacent structures when opening and closing to reduce the risk of entrapment. Swinging gates should not open into public access areas.
- The gate must be properly installed and work freely in both directions prior to the installation of the gate operator. Do not over-tighten the operator clutch, pressure relief valve or reduce reversing sensitivity to compensate for a damaged gate.
- For gate operators utilizing Type D protection:
  1. The gate operator controls must be placed so that the user has full view of the gate area when the gate is moving.
  2. A warning placard shall be placed adjacent to the controls.
  3. An automatic closing device (such as a timer, loop sensor, or similar device) shall not be employed.
  4. No other activation device shall be connected.
- Controls intended for user activation must be located at least ten feet (10') away from any moving part of the gate and where the user is prevented from reaching over, under, around or through the gate to operate the controls. Outdoor or easily accessible controls should have a security feature to prevent unauthorized use.
- The Stop and/or Reset button must be located in the line-of-sight of the gate. Activation of the reset control shall not cause the operator to start.
- A minimum of two (2) WARNING SIGNS shall be installed, one on each side of the gate where easily visible.
- For gate operators utilizing a non-contact sensor:
  1. See the instructions on the placement of non-contact sensors for each type of application.
  2. Care shall be exercised to reduce the risk of nuisance tripping, such as when a vehicle trips the sensor while the gate is still moving in the opening direction.
  3. One or more non-contact sensors shall be located where the risk of entrapment or obstruction exist, such as the perimeter reachable by a moving gate or barrier.



- For gate operators utilizing contact sensors:
  1. One or more contact sensors shall be located where the risk of entrapment or obstruction exist, such as at the leading edge, trailing edge, and post mounted both inside and outside of a vehicular horizontal slide gate.
  2. One or more contact sensors shall be located at the bottom edge of a vehicular vertical lift gate.
  3. One or more contact sensors shall be located at the pinch point of a vehicular vertical pivot gate.
  4. A hardwired contact sensor shall be located and its wiring arranged so that the communication between the sensor and the gate operator is not subjected to mechanical damage.
  5. A wireless contact sensor such as one that transmits radio frequency (RF) signals to the gate operator for entrapment protection functions shall be located where the transmission of the signals are not obstructed or impeded by building structures, natural landscaping or similar obstructions. A wireless contact sensor shall function under the intended end-use conditions.
  6. One or more contact sensors shall be located at the bottom edge of a vertical barrier (arm).

## Important Notices

Vehicular gate operator products provide convenience and security. However, gate operators must use high levels of force to move gates and most people underestimate the power of these systems and do not realize the potential hazards associated with an incorrectly designed or installed system. These hazards may include:

- Pinch points
- Entrapment areas
- Reach through hazards
- Absence of entrapment protection devices
- Improperly located access controls
- Absence of vehicle protection devices
- Absence of controlled pedestrian access

In addition to these potential hazards, automated vehicular gate systems must be installed in accordance with the UL 325 Safety Standard and the ASTM F2200 Construction Standard. Most lay persons are unaware of, or are not familiar with, these standards. If an automated vehicular gate system is not properly designed, installed, used and maintained, serious injuries or death can result. Be sure that the installer has instructed you on the proper operation of the gate and gate operator system.

Be sure that the installer has trained you about the basic functions of the required reversing systems associated with your gate operating system and how to test them. These include reversing loops, inherent reversing system, electric edges, photoelectric cells, or other external devices.

- This Owner's Manual is your property. Keep it in a safe place for future reference.
- Be sure that all access control devices are installed a minimum distance of 10 feet away from the gate and gate operator, or in such a way that a person cannot touch the gate or gate operator while using the device. If access control devices are installed in violation of these restrictions, immediately remove the gate operator from service and contact your installing dealer.
- Loops and loop detectors, photo-cells or other equivalent devices must be installed to prevent the gate from closing on vehicular traffic.
- The speed limit for vehicular traffic through the gate area is 5 MPH. Install speed bumps and signs to keep vehicular traffic from speeding through the gate area. Failure to adhere to posted speed limits can result in damage to the gate, gate operator, and to the vehicle.
- Be sure that all persons who will use the gate system are familiar with the proper use of the gate and gate operator and are familiar with the possible hazards associated with the gate system.
- Be sure that warning signs are permanently installed on both sides of the gate in an area where they are fully visible to traffic.
- It is your responsibility to periodically check all entrapment protection devices. If any of these devices are observed to function improperly, remove the operator from service immediately and contact your installing or servicing dealer.
- Follow the recommended maintenance schedule.
- Do not allow children to play in the area of the operator or to play with any gate-operating device.
- To remove the gate operator from service, operate the gate to the full open position and then shut off power to the operator at the service panel.

# UL 325 Entrapment Protection

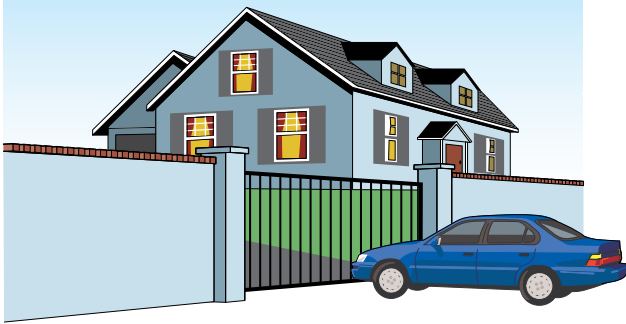

## Class I

A vehicular gate operator (or system) intended for use in a home of one-to four single family dwelling, or a garage or parking area associated therewith.

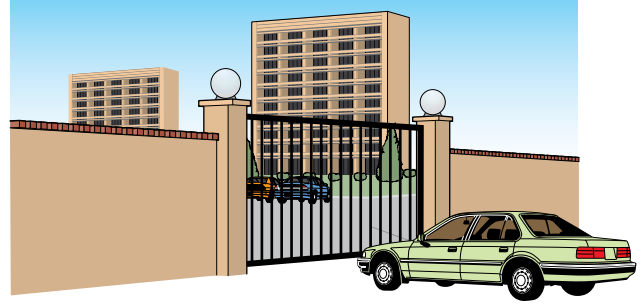

## Class II

A vehicular gate operator (or system) intended for use in a commercial location or building such as a multi-family housing unit (five or more single family units) hotel, garages, retail store or other building servicing the general public.

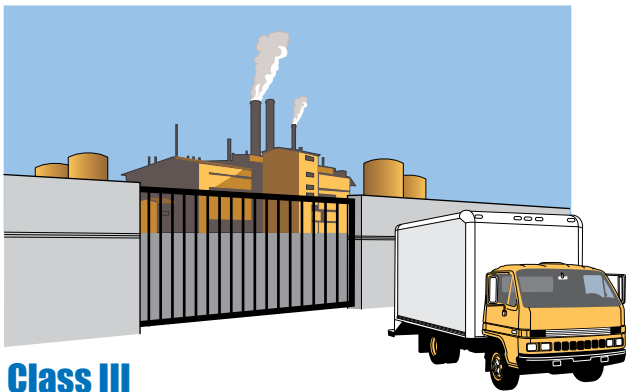

## Class III

A vehicular gate operator (or system) intended for use in an industrial location or building such as a factory or loading dock area or other locations not intended to service the general public.



## Class IV

A vehicular gate operator (or system) intended for use in a guarded industrial location or building such as an airport security area or other restricted access locations not servicing the general public, in which unauthorized access is prevented via supervision by security personnel.

**This table illustrates the entrapment protection requirements for each of the four UL 325 classes.**

UL 325 Classifications	Horizontal Slide, Vertical Lift, Vertical Pivot		Swing and Vertical Barrier (arm)	
	Primary Protection	Secondary Protection	Primary Protection	Secondary Protection
<b>Class I and II</b>	<b>A</b>	B1, B2 or D	<b>A or C</b>	A, B1, B2, C or D
<b>Class III</b>	<b>A, B1 or B2</b>	A, B1, B2, D or E	<b>A, B1, B2 or C</b>	A, B1, B2, C or D
<b>Class IV</b>	<b>A, B1, B2 or D</b>	A, B1, B2, D or E	<b>A, B1, B2, C or D</b>	A, B1, B2, C, D or E

- A** - Inherent entrapment protection system.
- B1** - Provision for connection of, or supplied with, a non-contact sensor (photoelectric sensor or the equivalent). When used as the PRIMARY device, must be monitored.
- B2** - Provision for connection of, or supplied with, a contact sensor (edge device or the equivalent). When used as the PRIMARY device, must be monitored.
- C** - Inherent adjustable clutch or pressure relief device.
- D** - Provision for connection of, or supplied with, an actuating device requiring continuous pressure to maintain opening or closing motion of the gate.
- E** - An inherent audio alarm.

# Glossary

**GATE** - A moving barrier such as a swinging, sliding, raising, lowering, or the like, barrier, that is a stand-alone passage barrier or is that portion of a wall or fence system that controls entrance and/or egress by persons or vehicles and completes the perimeter of a defined area.

**RESIDENTIAL VEHICULAR GATE OPERATOR – CLASS I** - A vehicular gate operator (or system) intended for use in a home of one-to four single family dwelling, or garage or parking area associated therewith.

**COMMERCIAL / GENERAL ACCESS VEHICULAR GATE OPERATOR - CLASS II** - A vehicular gate operator (or system) intended for use in a commercial location or building such as a multi-family housing unit (five or more single family units), hotels, garages, retail store, or other building servicing the general public.

**INDUSTRIAL / LIMITED ACCESS VEHICULAR GATE OPERATOR - CLASS III** - A vehicular gate operator (or system) intended for use in an industrial location or building such as a factory or loading dock area or other locations not intended to service the general public.

**RESTRICTED ACCESS VEHICULAR GATE OPERATOR - CLASS IV** - A vehicular gate operator (or system) intended for use in a guarded industrial location or building such as an airport security area or other restricted access locations not servicing the general public, in which unauthorized access is prevented via supervision by security personnel.

**VEHICULAR BARRIER (ARM) OPERATOR (OR SYSTEM)** - An operator (or system) that controls a cantilever type device (or system), consisting of a mechanical arm or barrier that moves in a vertical arc, intended for vehicular traffic flow at entrances or exits to areas such as parking garages, lots or toll areas.

**VEHICULAR HORIZONTAL SLIDE-GATE OPERATOR (OR SYSTEM)** - A vehicular gate operator (or system) that controls a gate which slides in a horizontal direction that is intended for use for vehicular entrance and exit to a drive, parking lot, or the like.

**VEHICULAR SWING-GATE OPERATOR (OR SYSTEM)** - A vehicular gate operator (or system) that controls a gate which moves in an arc in a horizontal plane that is intended for use for vehicular entrance and exit to a drive, parking lot, or the like.

**SYSTEM** - In the context of these requirements, a system refers to a group of interacting devices intended to perform a common function.

**WIRED CONTROL** - A control implemented in a form of fixed physical interconnections between the control, the associated devices, and an operator to perform predetermined functions in response to input signals.

**WIRELESS CONTROL** - A control implemented in means other than fixed physical interconnections (such as radio waves or infrared beams) between the control, the associated devices, and an operator to perform predetermined functions in response to input signals.

**INHERENT ENTRAPMENT PROTECTION SYSTEM** - A system, examples being a motor current or speed sensing system, which provides protection against entrapment upon sensing an object and is incorporated as a permanent and integral part of the operator.

**EXTERNAL ENTRAPMENT PROTECTION DEVICE** - A device, examples being an edge sensor, a photoelectric sensor, or similar entrapment protection device, which provides protection against entrapment when activated and is not incorporated as a permanent part of an operator.

**ENTRAPMENT** - The condition when an object is caught or held in a position that increases the risk of injury.

# SECTION 1 - INSTALLATION

Prior to beginning the installation of the slide gate operator, we suggest that you become familiar with the instructions, illustrations, and wiring guide-lines in this manual. This will help insure that your installation is performed in an efficient and professional manner compliant with UL 325 safety and ASTM F2200 construction standards.

The proper installation of the vehicular slide gate operator is an extremely important and integral part of the overall access control system. Check all local building ordinances and building codes prior to installing this operator. Be sure your installation is in compliance with local codes.

## 1.1 Hardware for the Gate

Good hardware is essential for proper operation of a sliding gate. DoorKing has a full line of gate hardware products that will ensure safe, reliable and long lasting gate operation. The gate must be properly installed and roll smoothly in both directions.

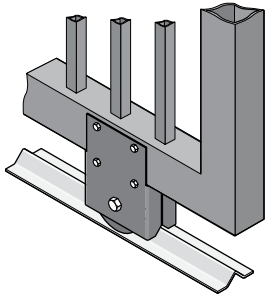

**Roller Bearing V-Wheels with Protective Cover** - Helps to minimize a pinch point on the gate's wheel and V-rail.

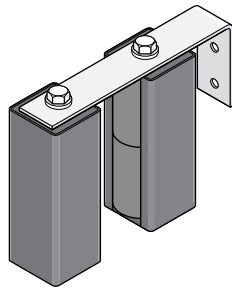

**Guide Rollers with Protective Covers** - Helps to minimize a pinch point on the gate.

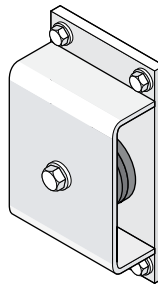

**Endless Idler Assembly with Protective Cover** - Helps to minimize a pinch point for a 180° chain return.

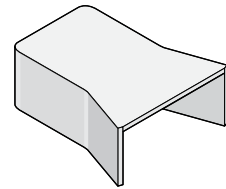

**Gate End Retainer** - Helps stabilize the end of the gate in the open or closed position.

## 1.2 Underground Conduit Requirements

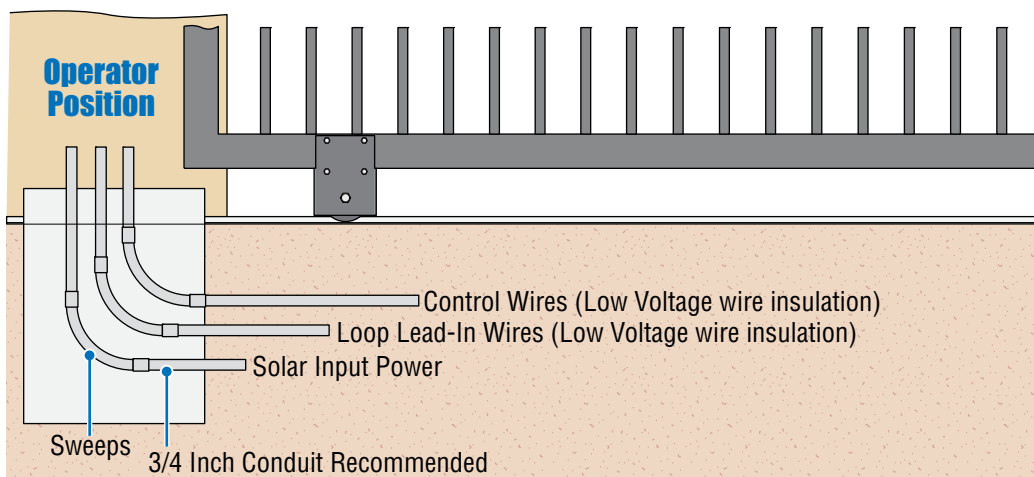

- The conduit requirements are for a typical slide gate operator installation). **The conduit requirements for your application may vary from this depending on your specific needs.**
- Use only sweeps for conduit bends. Do not use 90° elbows as this will make wire pulls very difficult and can cause damage to wire insulation.
- DoorKing recommends using 3/4-inch conduit.
- Be sure that all conduits are installed in accordance with local codes.
- **Never** run low voltage rated wire insulation in the same conduit as high voltage rated wire insulation.

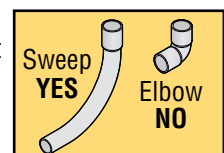

## 1.3 Typical Gate Types

The Model 9024 operator is designed to be installed on any of these gate types. See pages 13-15 for specific operator mounting positions.

- Steel or Aluminum.
- 1,000 lb max. weight per gate.
- Chain tray recommended for gates over 20 ft.  
(Post mount installation when using a chain tray.)
- 40 ft max gate length.

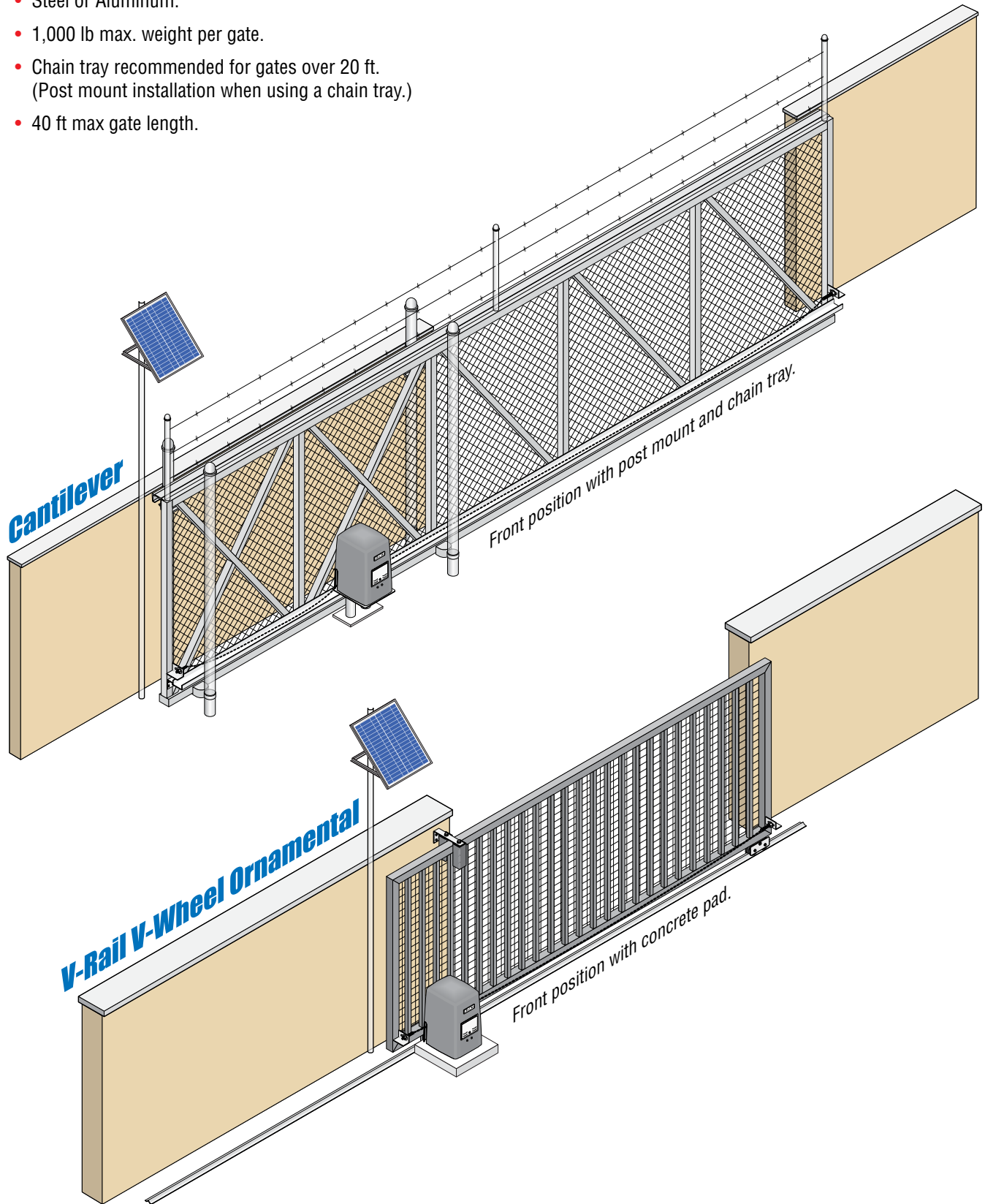

## 1.4 Concerns BEFORE Solar Panel Installation

Correct positioning of the solar panel will determine the efficiency of the system. In general, the panel should be facing **TRUE SOUTH** at a specific **TILT ANGLE** towards the sun using the information provided on the next page to achieve the highest efficiency. Some re-adjustment of the panel might be necessary to over time to “Fine Tune” the systems efficiency. The solar panel should be installed as close as possible to the operator in an area free and clear of **ALL** obstructions and shadows during the **ENTIRE** day. Generally, If the solar panel does **NOT** cast a shadow by the sun, the batteries are **NOT** being charged.

- **Trees / Buildings** that do not block the solar panel from direct sunlight in the summer, **could** block the panel during the winter. The sun’s path across the sky is lower during the winter than in the summer. The shadows that do not obstruct the solar panel during the summer months, will cast longer shadows in the winter, which could block the panel then.
- **Wind** can exert extreme pressure on the solar panel and support post. Make sure they are securely fastened.
- **Dust** can accumulate on the panel over time. Cleaning the panel every so often is necessary to keep the system operating at its highest efficiency.
- **Snow** may cover the panel during the winter. You may want to re-adjust the panel to a steeper angle to allow the snow to slide off. Even then, the panel may still accumulate snow and need to be manually cleaned off when necessary to keep the system functioning.

### Mounting Recommendations

The solar panel will perform **MOST** efficient when installed as close as possible to the operator (Within a couple of feet). Keep in mind, the efficiency of the solar panel will diminish the farther away the panel is installed from the operator.

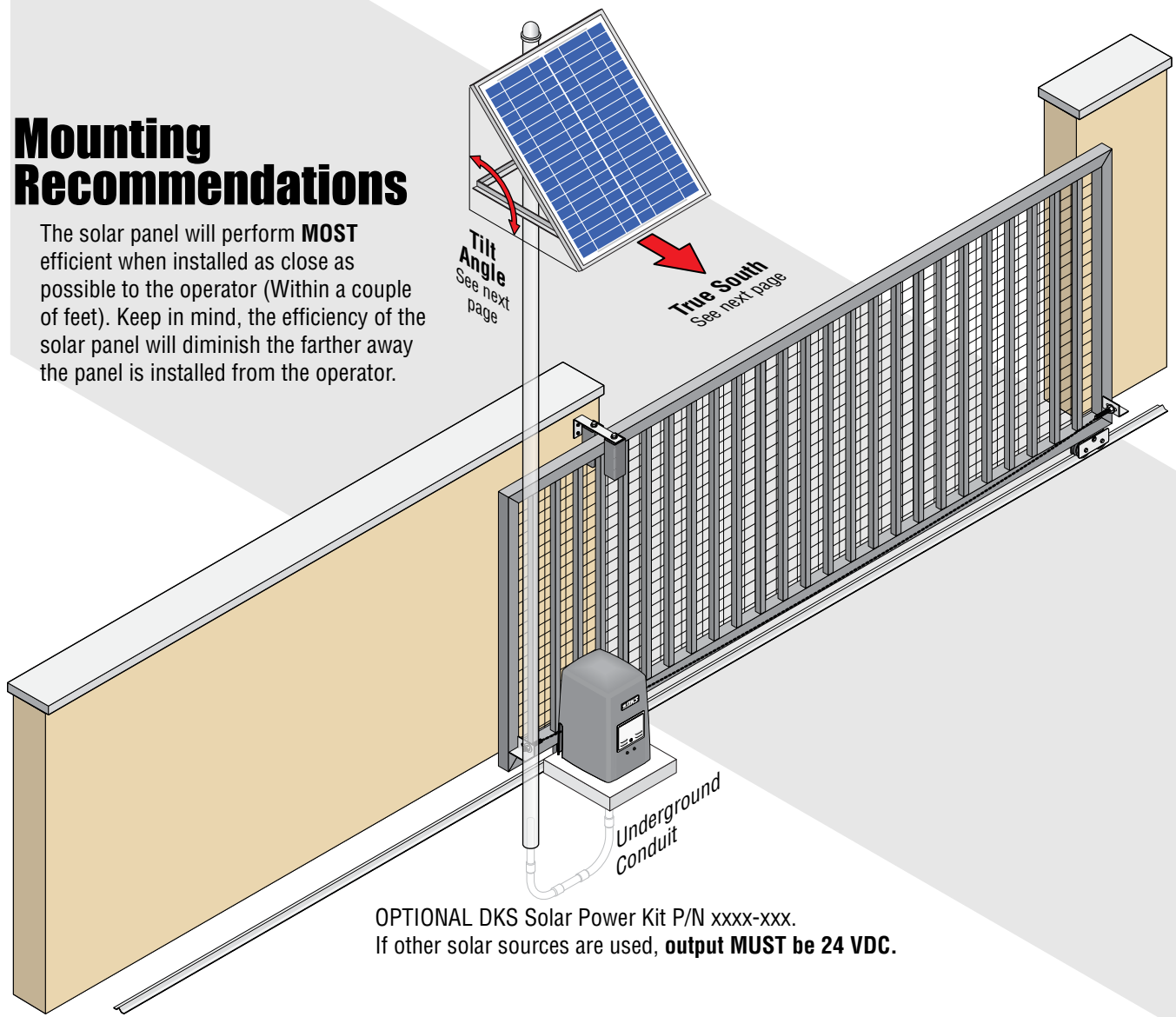



# 1.5 Solar Panel Positioning

These charts should be used only for estimates. Solar systems can vary from this information. These maps do not take into account small climate changes and may not be 100% accurate for all locations.

## Solar Panel MUST Point “TRUE SOUTH”

It is important for proper system operation that the solar panel is oriented to **TRUE SOUTH**. The directions of magnetic South and TRUE South differ from one another depending on geographic location. The map below shows the difference between magnetic south and TRUE south for your area.

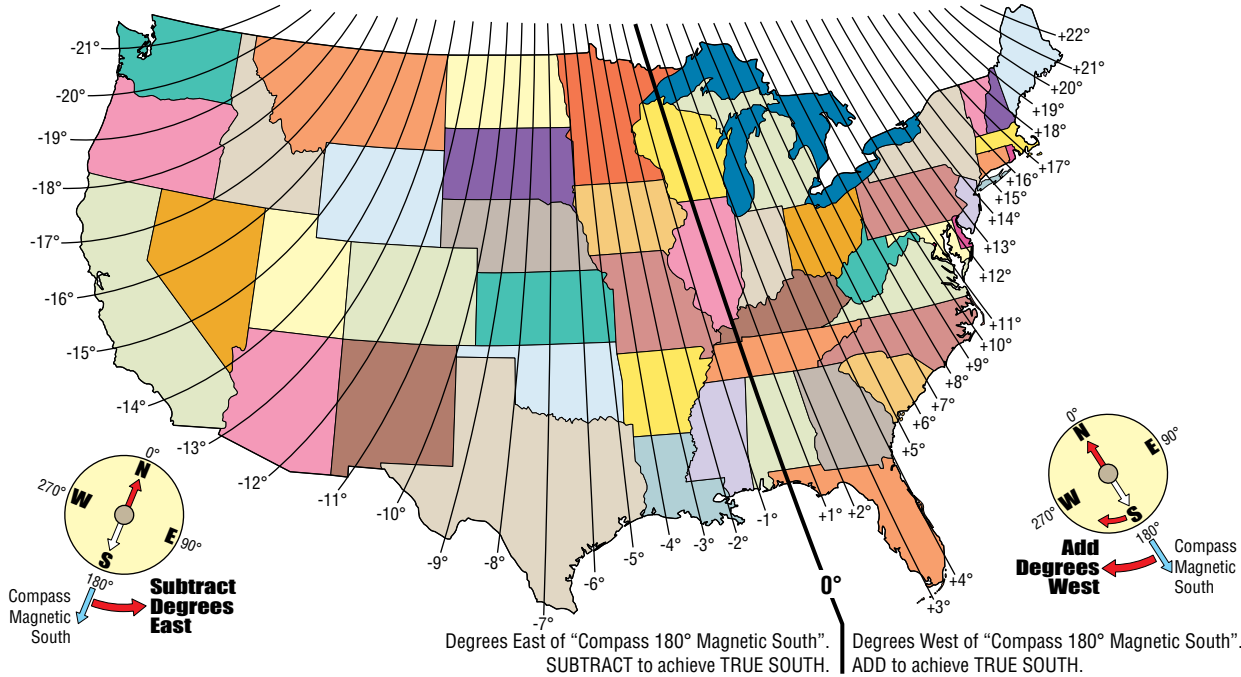

## General Solar Panel “Tilt Angle”

It is simplest to mount the solar panel at a fixed tilt angle and leave it (Shown on chart below). To capture more energy from the sun, you can adjust the tilt angle of the solar panel twice a year (At the beginning of summer and winter). Add approximately 6° in the summer and subtract approximately 6° in the winter from your “general” tilt angle on this chart. Your tilt angle may vary from this.

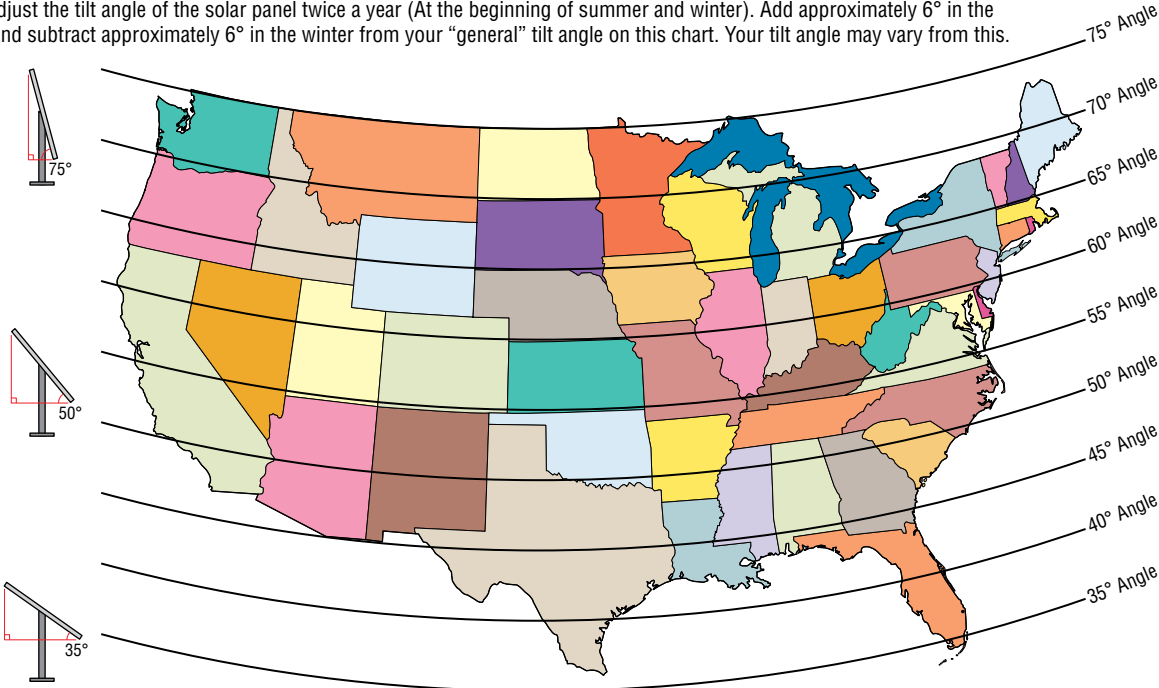



# 1.6 Operator Mounting Positions

The Model 9024 operator is designed to be installed in the front, rear and center mounting positions shown on this page and the next 2 pages. V-wheel V-rail ornamental gates are shown as examples but other gate types on the previous page can use the same mounting setups. Once the mounting position has been selected, refer to pages 16 thru 19 for specific installation instructions.

## Front Position with Concrete Pad

Standard method of installation.

- Operator's chain idler wheels are factory set in the top position.

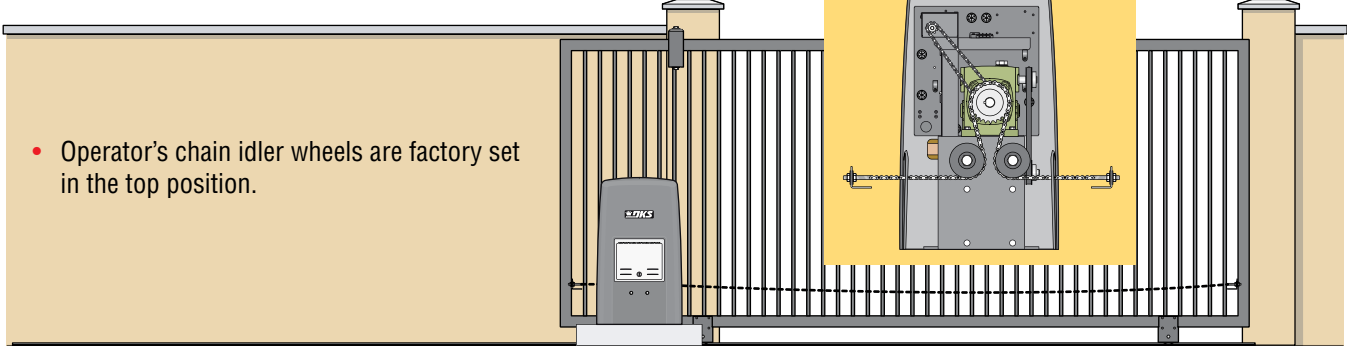
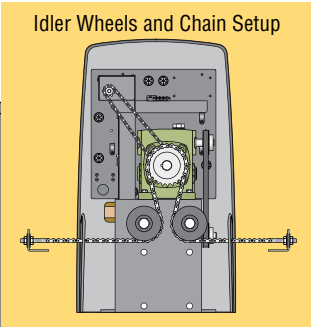

**Top View**

A filler post or barrier may need to be installed between the gate and wall area (See page 3 for more information).

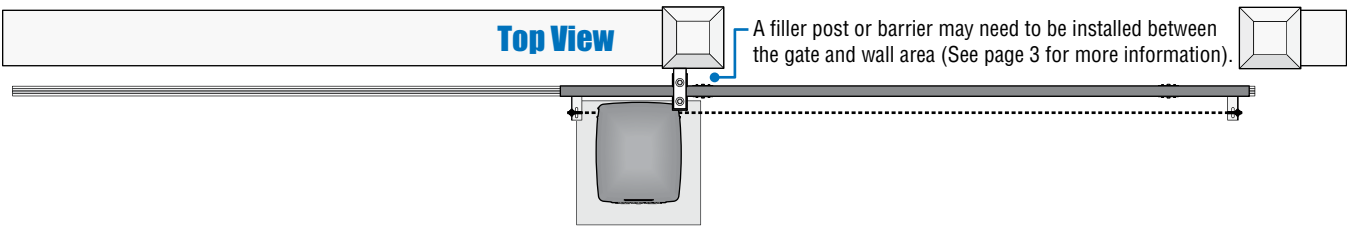

## Front Position with Post Mount Kit

Raises operator and allows different chain heights.

- Set operator chain idler wheels in the bottom position.
- Optional chain tray kit may be installed. See page 19 for more information.

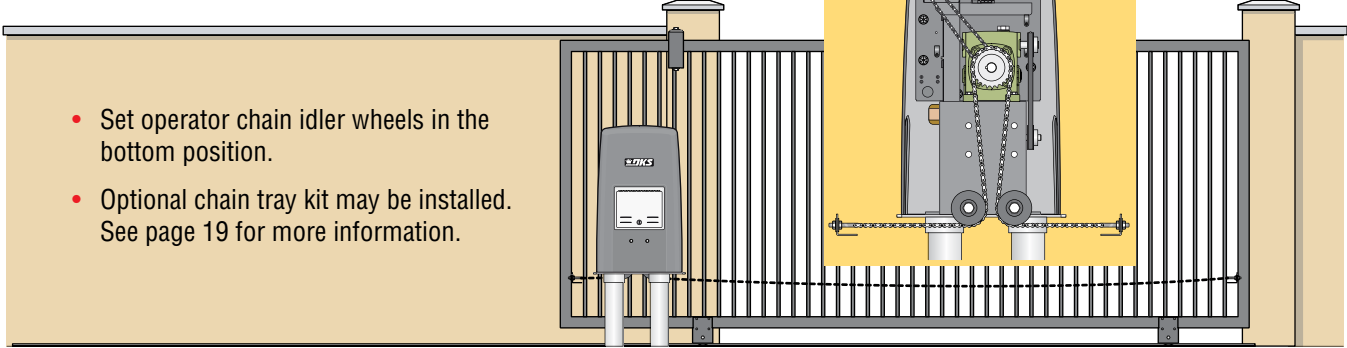
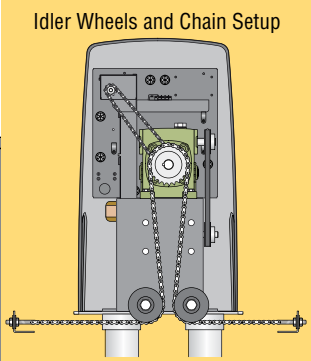

**Top View**

A filler post or barrier may need to be installed between the gate and wall area (See page 3 for more information).

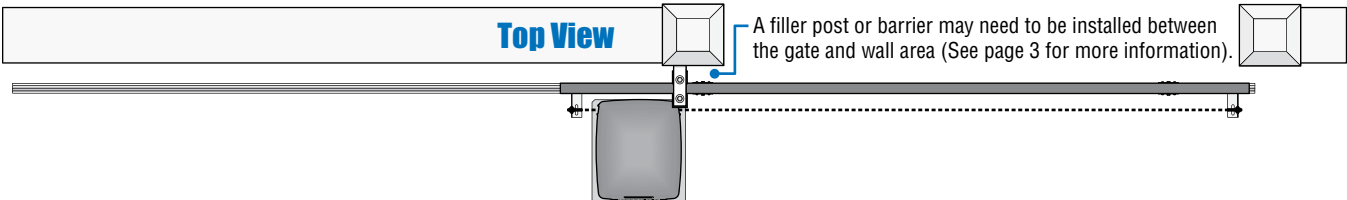

**Additional hardware required.** Post mount kit (P/N 9000-015).

## Rear Position with Concrete Pad

Hides the chain from outside the property looking in.

- Set one chain Idler wheel at the top and one in the center position.

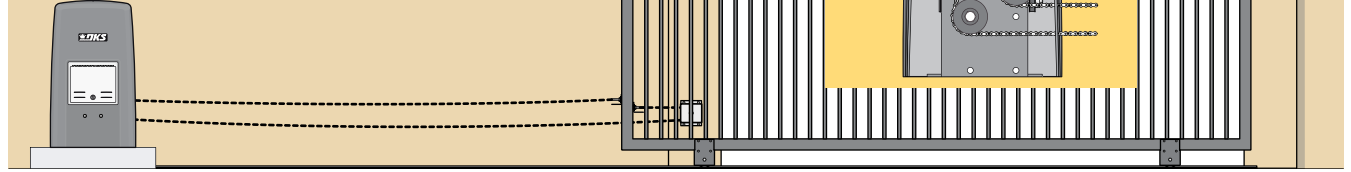

### Top View

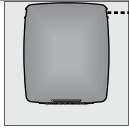

A filler post or barrier may need to be installed between the gate and wall area (See page 3 for more information).

**Additional hardware required.** Endless idler assembly (P/N 2600-818) and additional chain #40 (P/N 2600-442 - 20 ft. per box) may be needed.

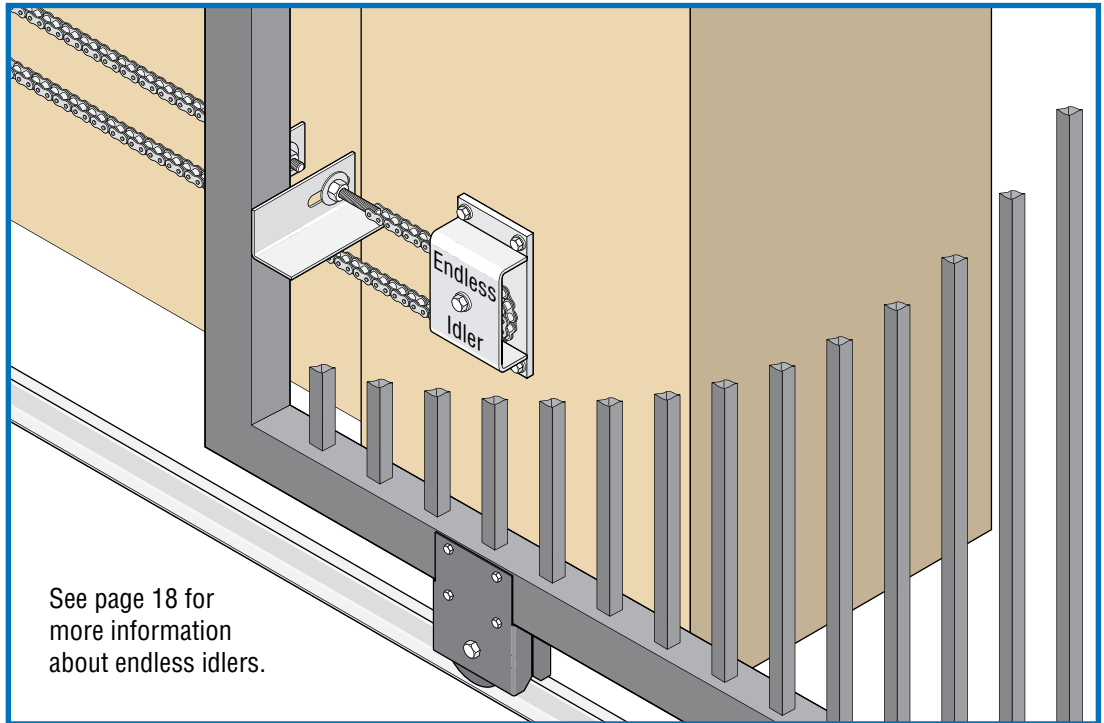

See page 18 for more information about endless idlers.

## Rear Position with Post Mount Kit

Raises operator and allows different chain heights.

- Set one chain Idler wheel at the center and one in the bottom position.
- See page 16 and the post mount instruction sheet included with the kit for more information about post installation.

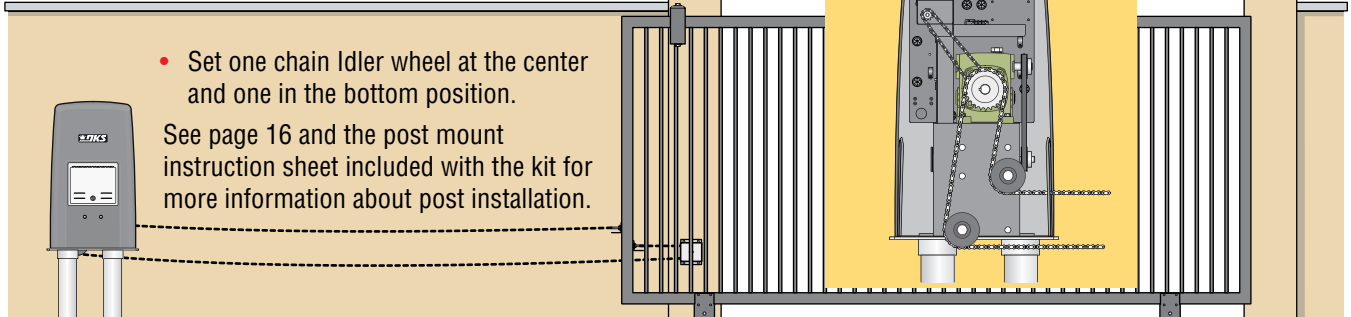

**Additional hardware required.** Post mount kit (P/N 9000-015). Endless idler assembly (P/N 2600-818) and additional chain #40 (P/N 2600-442 - 20 ft. per box) may be needed.

# Center Position with Post Mount Kit

Hides the chain from outside the property looking in. Allows the use of DoorKing's chain tray kit to attach to gate. This is useful with long gates. It supports the chain's weight and helps prevent chain "stretching".

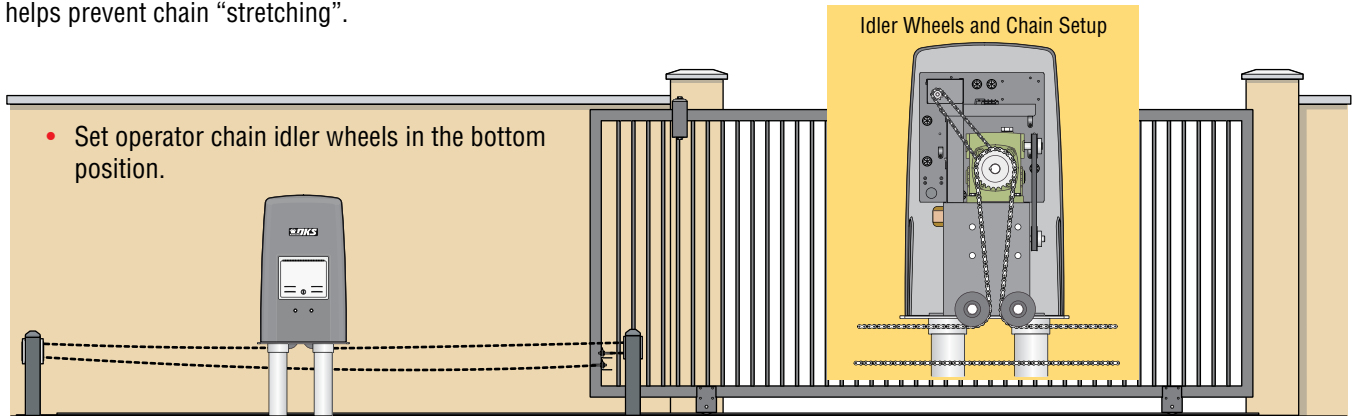

See next page and the post mount instruction sheet included with the kit for more information about post installation.

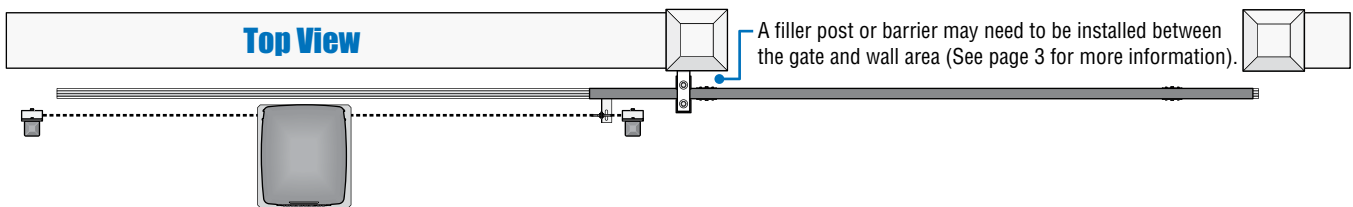

**Additional hardware required.** Post mount kit (P/N 9000-015). Endless idler assembly (P/N 2600-818) and additional chain #40 (P/N 2600-442 - 20 ft. per box) may be needed.

## Gate in Open Position

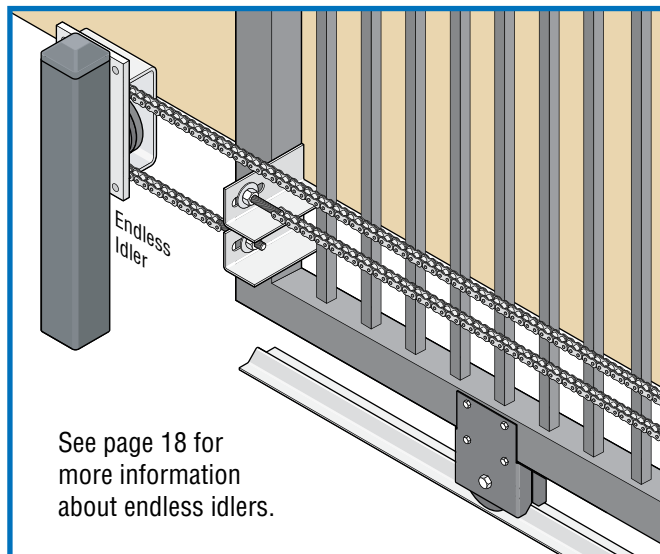

## Gate in Close Position

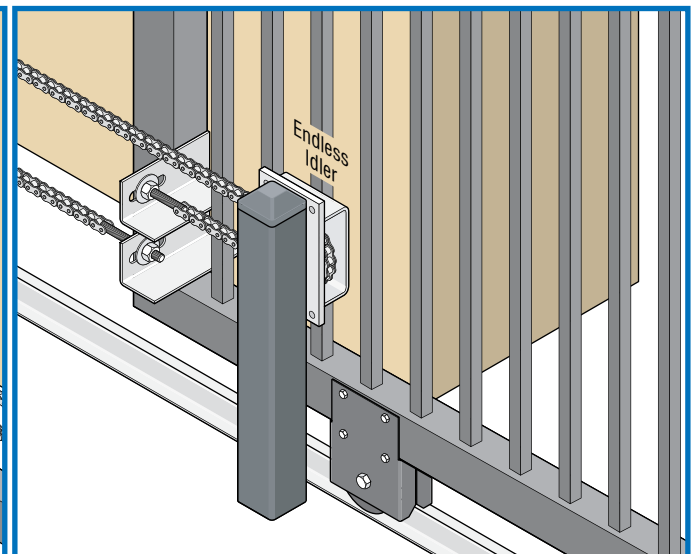

## DoorKing's Chain Tray Kit for Long Gates

See page 19 for more information.

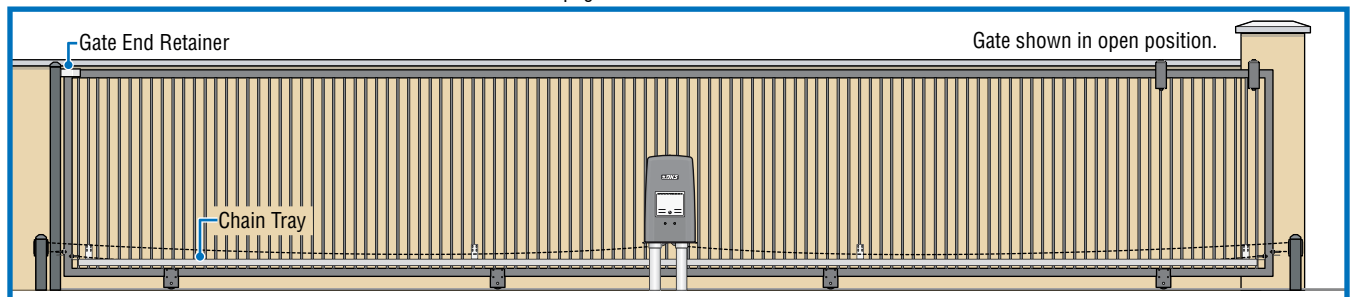

# 1.7 Concrete Pad Setup OR Post Mounting

## Concrete Pad Setup

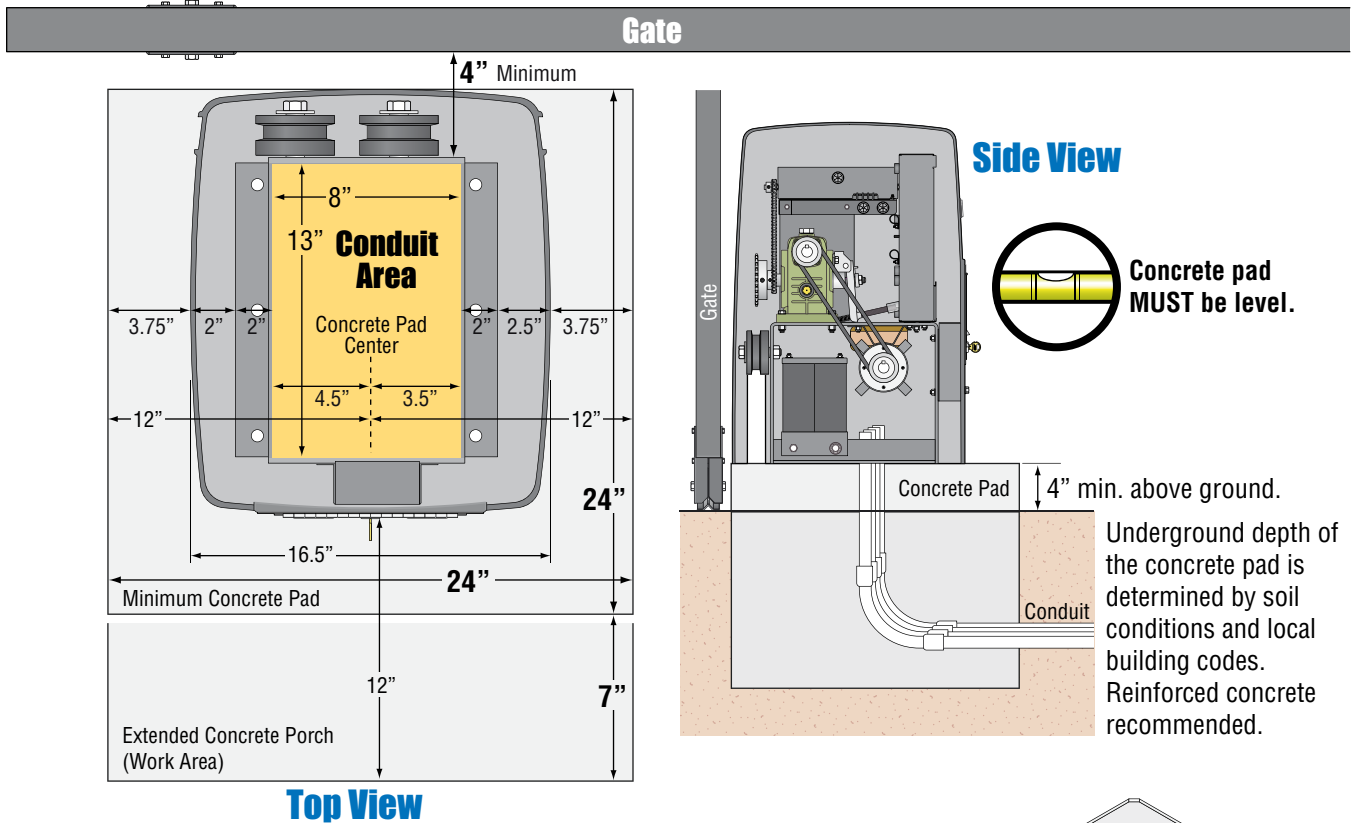

## Optional Post Mount Kit

DoorKing offers a post mount kit specifically for the Model 9024 (P/N 9000-015). The kit includes a base plate, 2 posts and hardware to attach the operator to the base plate. This kit will raise the operator and allow different chain heights for specific operator applications. Refer to the instruction sheet provided with the kit for concrete foundation size, conduit type and placement. This kit is needed if a chain tray is required to support the chain's weight when a longer gate is used (See page 19 for more information about DoorKing's chain tray kit).

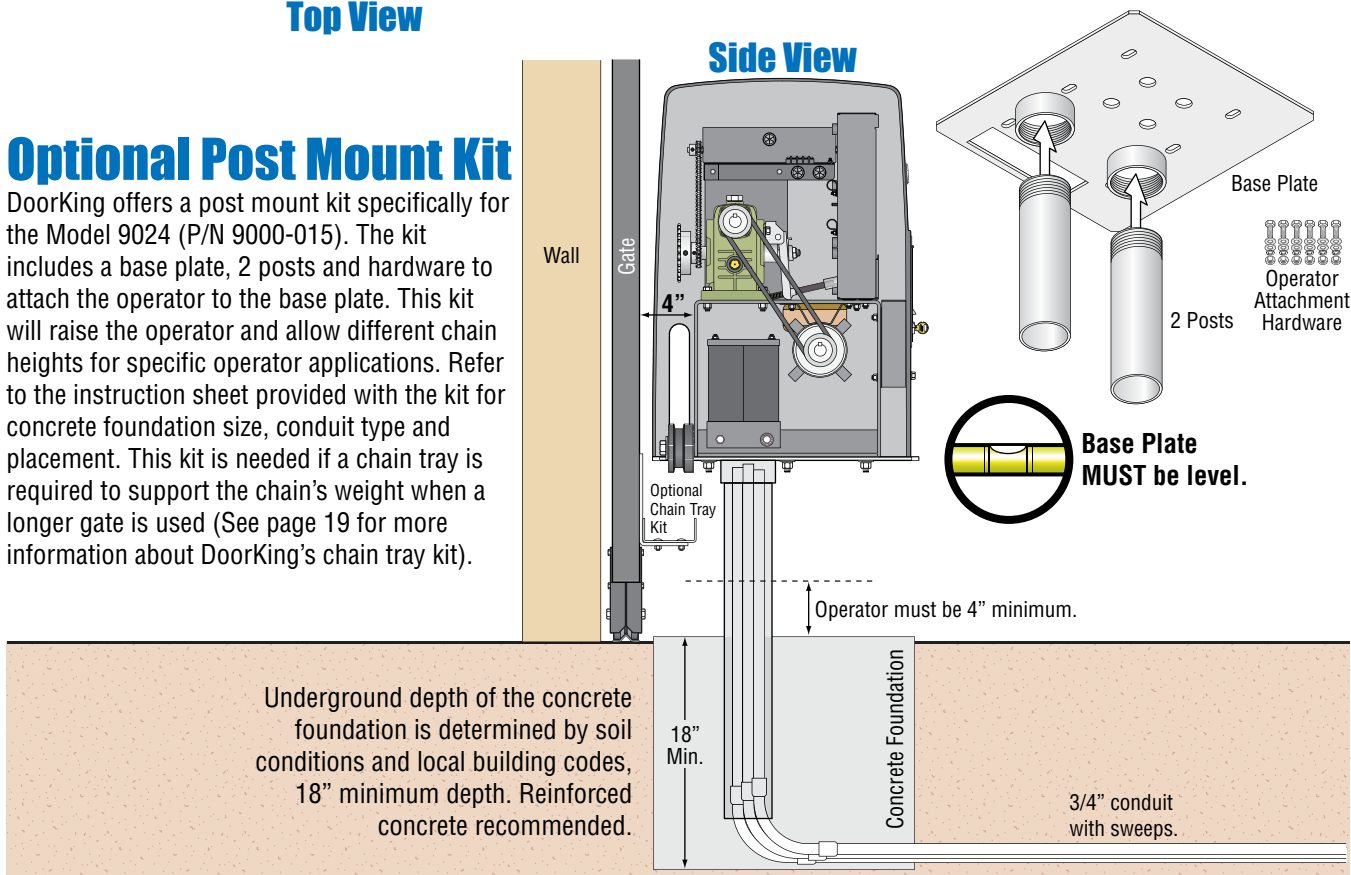

# 1.8 Positioning Operator and Chain

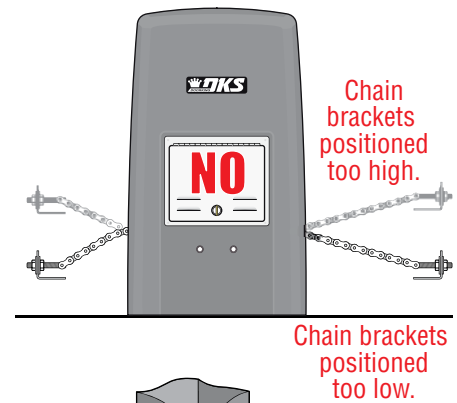
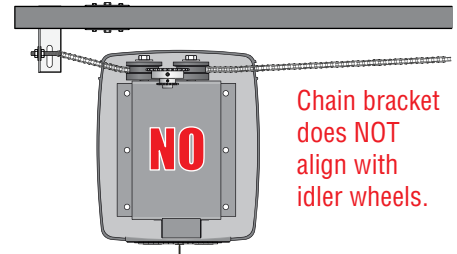
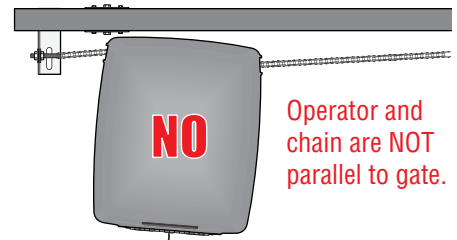
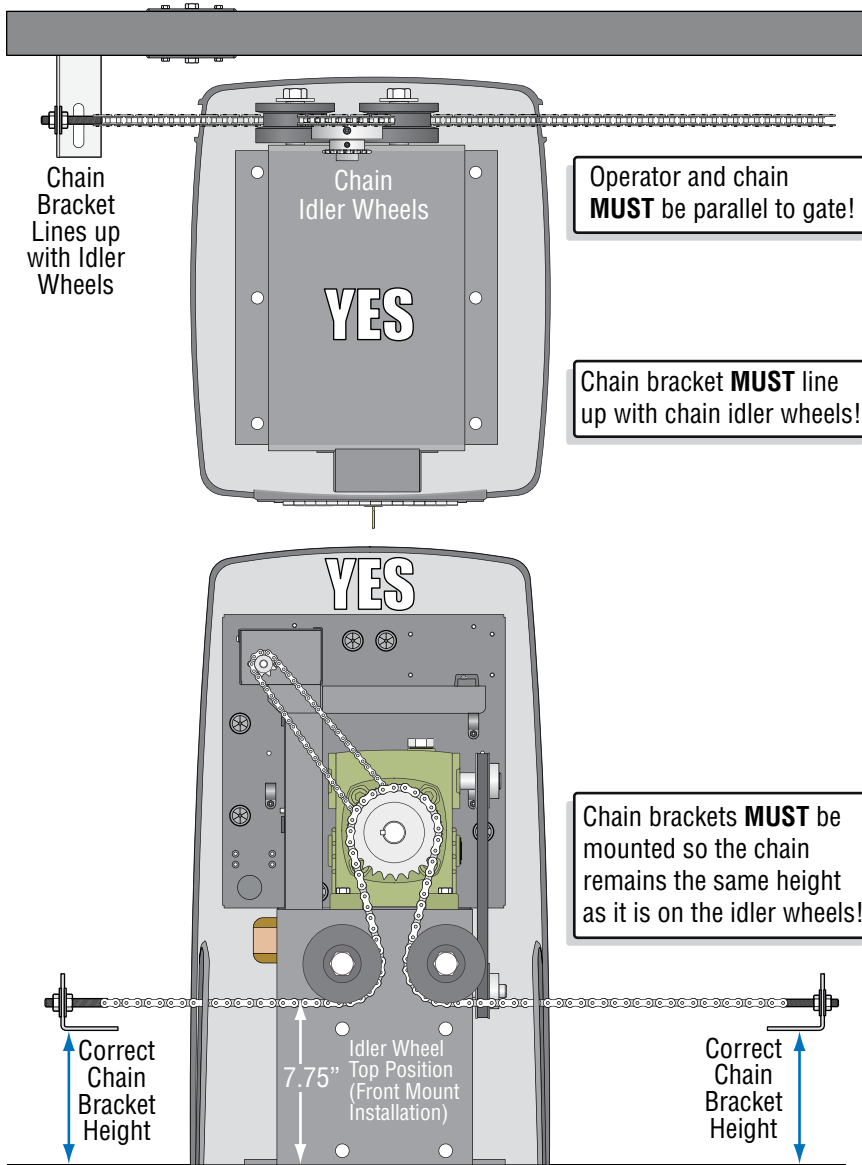

# 1.9 Attaching Operator and Chain

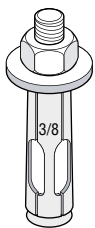

**Attaching Operator to Concrete Pad**  
DoorKing recommends a minimum of four (4) 3/8" x 2" sleeve anchors (not supplied).

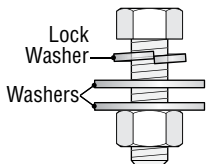

**Attaching Operator to Post Mount Plate**  
Use bolts provided in post mount kit.

**Connect Chain Bracket to Gate.** Weld completely around bracket. Chain nut and chain bolt should not protrude past gate frame.

**Connect Chain to Chain Bracket.** Connect chain to chain bolt with master link. Adjust the chain nuts to tighten the chain. The chain should sag no more than one (1) inch per 10 feet of travel. **Do not over tighten the chain.**

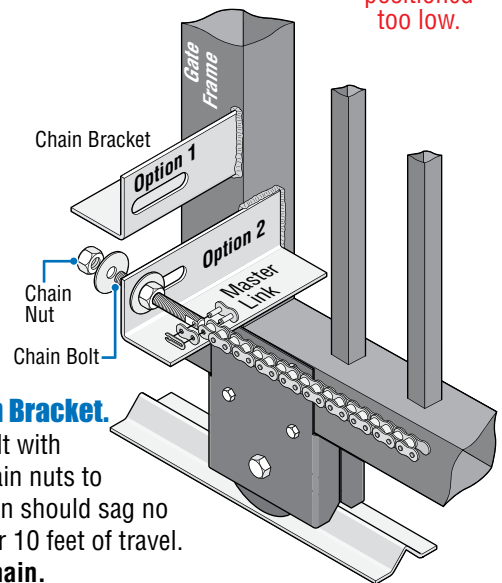

# 1.10 Endless Idler Assembly (On Select Installations)

DoorKing offers an endless idler assembly with a protective cover designed for the Model 9024 installations (P/N 2600-818). Make sure the endless idler assembly is **securely** fastened to the wall or post (Depending on which type of installation will be used). Extreme force will be exerted on this assembly during gate cycling.

## Center and Rear Mount Positions (Top View)

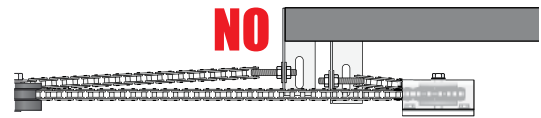
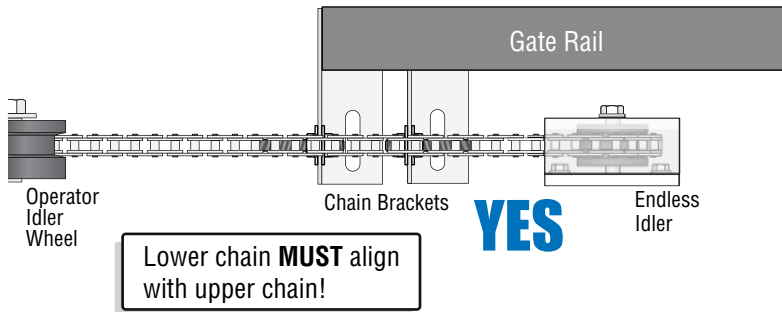

Lower chain does **NOT** align with upper chain.  
 Note: Be sure that the chain is aligned and parallel to the gate. Installing the chain in any other manner will cause excessive noise, chain idler wheel wear and chain stretching.

## Center Mount Position (Side View)

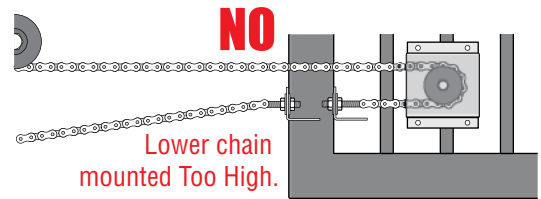
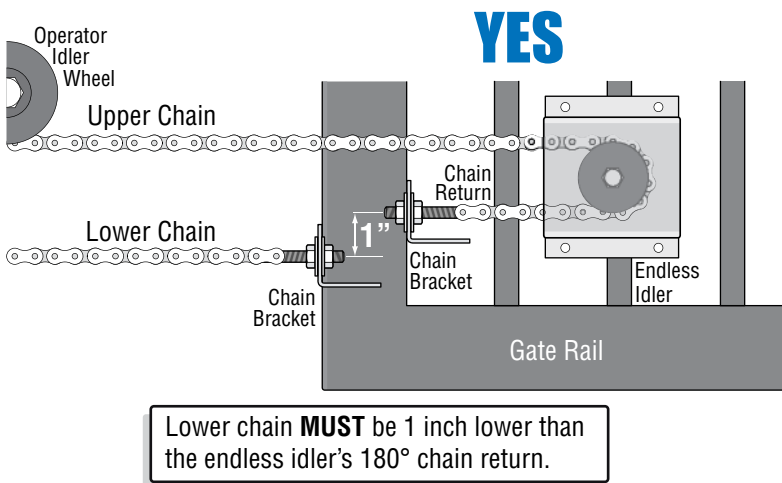

Lower chain mounted Too High.

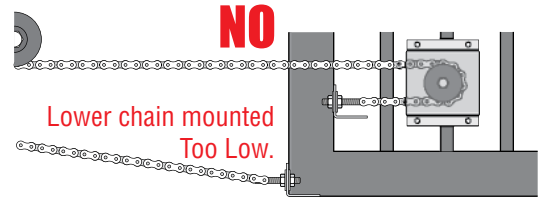

Lower chain mounted Too Low.

## Rear Mount Position (Side View)

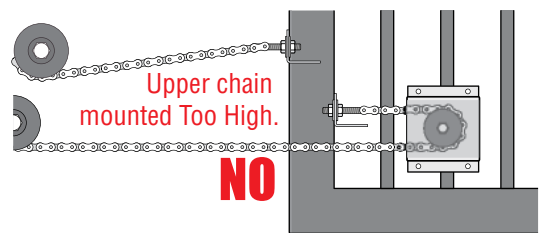
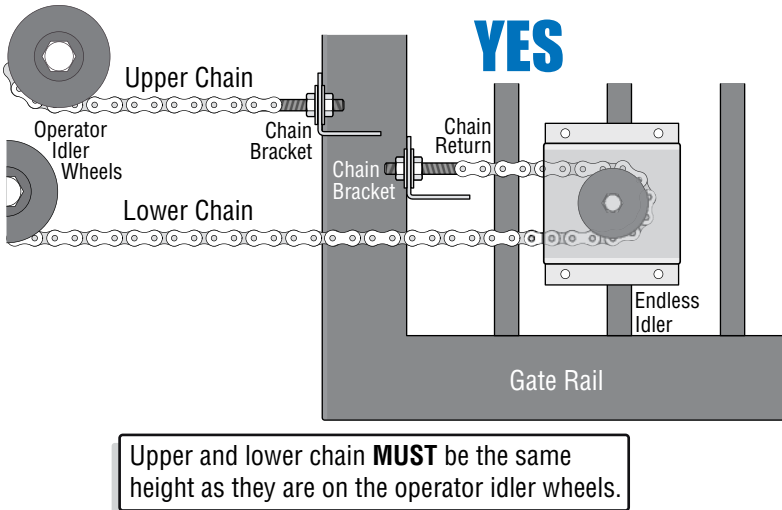

Upper chain mounted Too High.

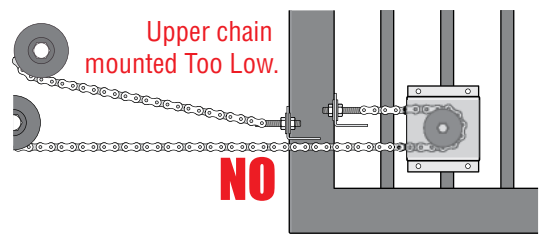

Upper chain mounted Too Low.

## 1.11 DoorKing's Chain Tray Kit

A chain tray is recommended for gates longer than 20 ft. to support the weight of the chain. DoorKing offers a chain tray kit in 10 ft. sections to fit any length gate. (DoorKing P/N 2601-270 10 Ft. section)

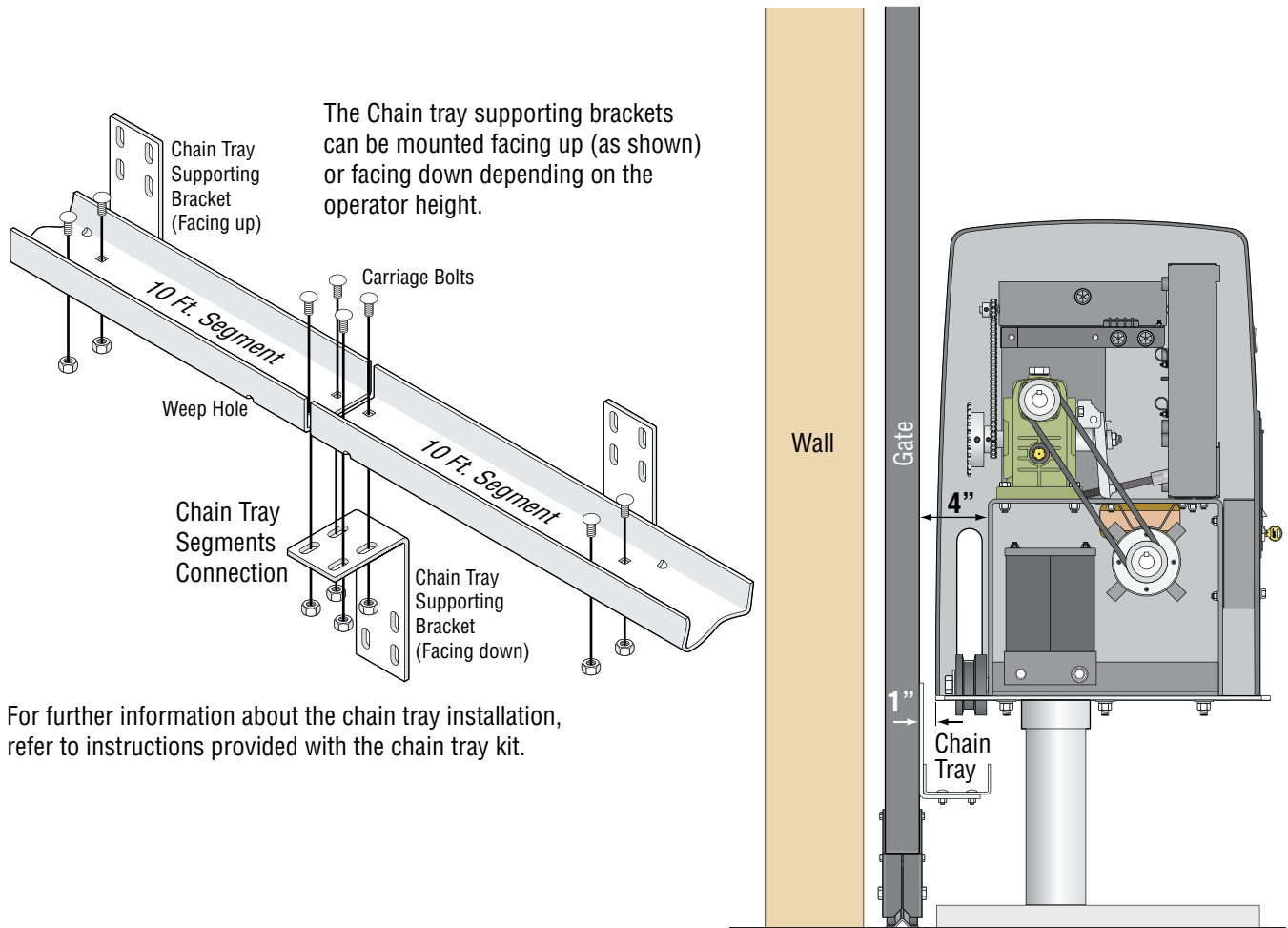

For further information about the chain tray installation, refer to instructions provided with the chain tray kit.

## 1.12 Installation of Warning Signs

This DoorKing Slide Gate Operator is shipped with two warning signs. The purpose of the warning sign is to alert uninformed persons, and to remind persons familiar with the gate system, that a possible hazard exists so that appropriate action can be taken to avoid the hazard or to reduce exposure to the hazard. See page 4 for suggested mounting positions of signs.

- Permanently install the supplied warning signs in locations so that the signs are visible by persons on both sides of the gate.
- Use appropriate hardware such as wood or sheet metal screws (not supplied) to install the warning signs.

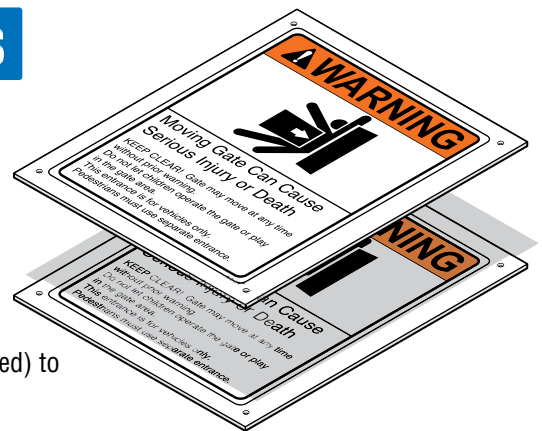



# SECTION 2 - SOLAR INPUT POWER TO OPERATOR

Before connecting the solar panel wire to the operator, make sure that the solar panel is blocked from the sunlight.

**The solar panel is "HOT" (discharging power) whenever the sun is shining on it. It will shock you if you attempt to touch the wires while it is in the sunlight!**

Permanent wiring must be installed to the operator as required by local electrical codes. It is recommended that a licensed electrical contractor perform this work.

**Since building codes vary from city to city, we highly recommend that you check with your local building department prior to installing any permanent wiring to be sure that all wiring to the operator (both high and low voltage) complies with local code requirements.**

**THIS GATE OPERATOR MUST BE PROPERLY GROUNDED!!**

## 2.1 Solar Power Connections

Connect **ONLY 24 VDC** power. DoorKing Solar Power Kit P/N XXXX-XXX is recommended. Third party **24 VDC batteries and solar panel** can be used if desired.

The solar panel will perform **MOST** efficient when installed as close as possible to the operator (Within a couple of feet). Keep in mind, the efficiency of the solar panel will diminish the farther away the panel is installed from the operator.

- **DO NOT** install a heater kit when using solar power.

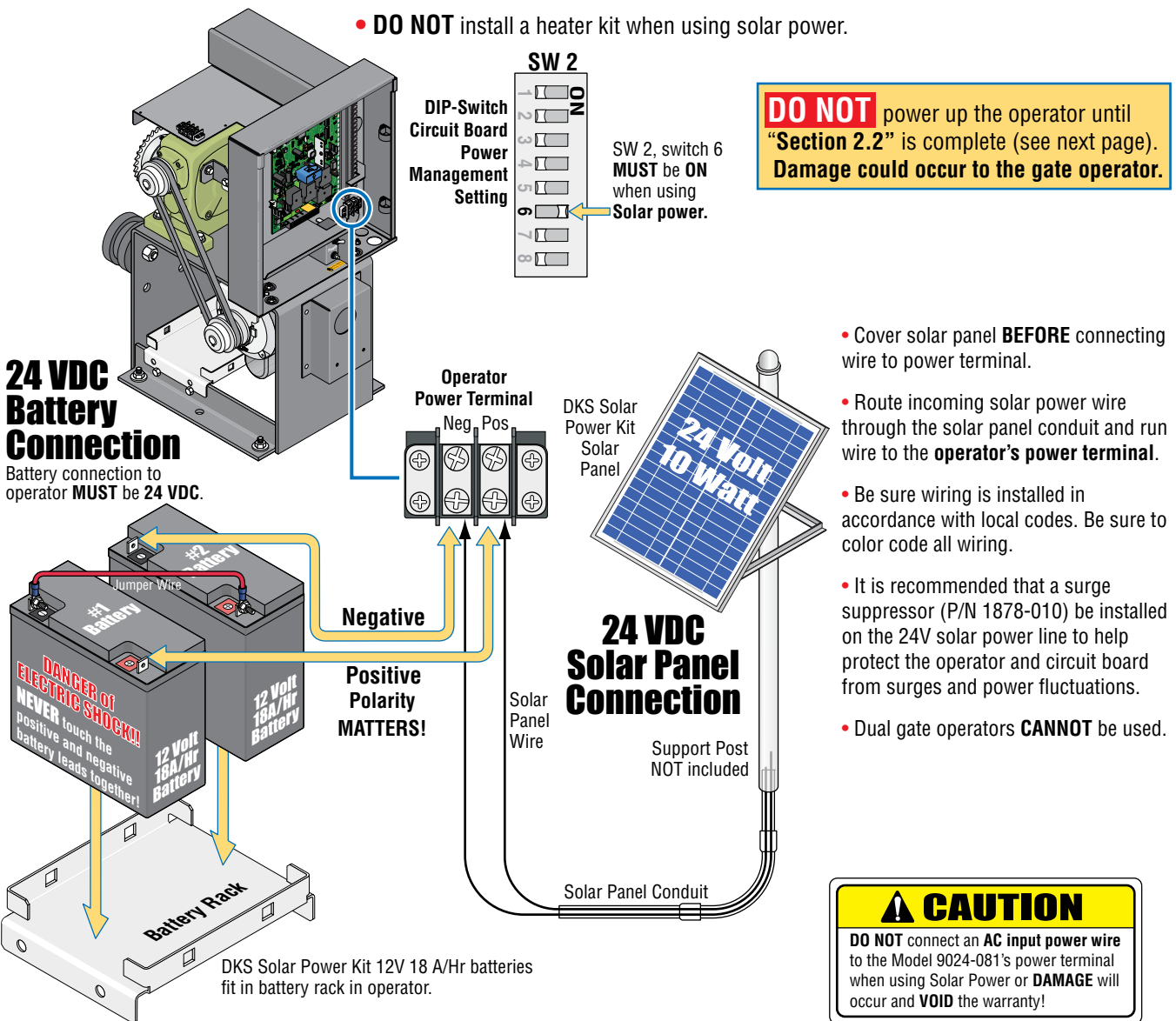

## 2.2 Power Select Jumper and Turning Power ON

The “POWER SEL” jumper on the circuit board **MUST** be set correctly or operator will not function correctly.

**DO NOT** cycle the operator until the “DIP-Switches” and the “Limit Switches” have been adjusted. **Damage could occur to the gate and gate operator.** See pages 23-25.

**To power up operator:** turn DC power switch **ON**. Press **KEY SWITCH** and LEDs will light up on circuit board.

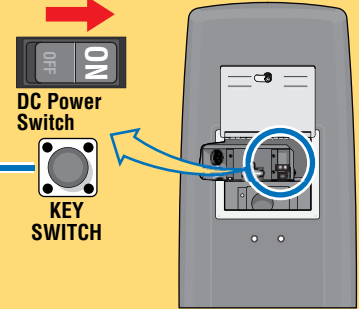
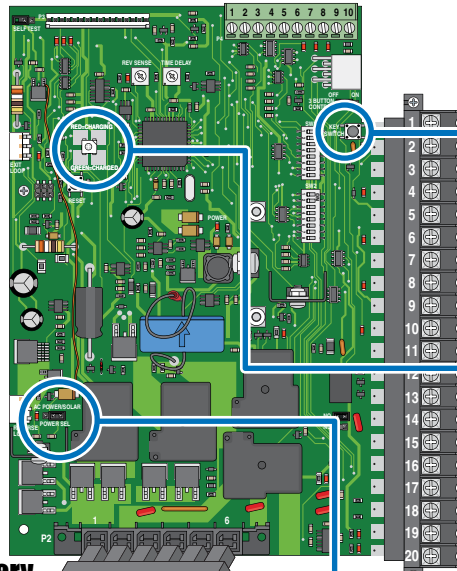

RED=CHARGING  
Battery Charging LED Monitor

GREEN=CHARGED

This may be red when first powering up operator depending on how much of a charge the batteries have.

**Important Battery Plug Note:** Battery Plug P2 comes from the factory unplugged and needs to be plugged into circuit board when operator is ready to be powered up.

Battery Plug P2

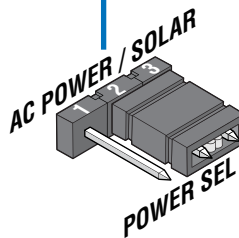

### POWER SEL Jumper

**Important:** Pins 2 and 3 **MUST** be jumpered together when using solar input power to **manage power drain** from circuit board.

**DO NOT** jumper pins 1 and 2 together or circuit board will not manage power and **continually draw FULL power** from the batteries.

### Power Management of Circuit Board

The operator manages the power drain of the circuit board by powering down unused inputs on the board when the operator is idle. When the gate has been closed for 5 min.

or held open for 5 min., the circuit board powers down unused inputs to conserve power drain. **Main terminals 1, 2, 3 and loop detector ports NEVER** power down. Any activation from one of these inputs will power up the circuit board when it is in the powered down mode. It is important to have low current draw devices connected to these specific inputs or operator performance will be **significantly reduced**.

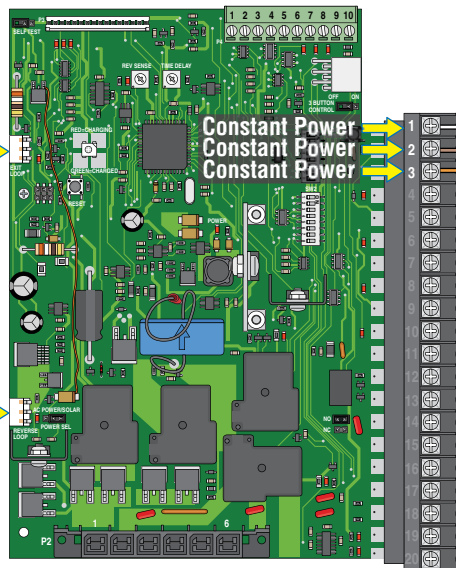

Constant Power

**Loop Detectors:** DoorKing’s low current draw plug-in loop detectors are specifically designed to be connected to a solar powered gate operator. If using a third party external loop detectors, they **MUST** be a low current draw type.

Constant Power

Constant Power  
Constant Power  
Constant Power

**3-Pin Remote Terminal**  
Power is limited to 250 mamps.

**Radio Receiver:** DoorKing’s 3-wire radio receiver is specifically designed to be connected to a solar powered gate operator. If using a third party radio receiver, it **MUST** be a low current draw radio receiver type.

# SECTION 3 - ADJUSTMENTS

The switch settings and adjustments in this chapter should be made after your installation and wiring to the operator(s) is complete. **Whenever any of the programming DIP-switches on the circuit board are changed, reset button MUST be pressed before the new setting will take effect.**

## 3.1 4100 Circuit Board Descriptions and Adjustments

### How LEDs Function



Illuminated LEDs indicates that low voltage power is being applied to the circuit board.

**Input LEDs** should be OFF and will only illuminate when the input that is next to the LED is activated. See page 31.

**Limit LEDs** will only illuminate when the respective limit switch has been activated.

**Loop LEDs** will only illuminate when a reverse or exit loop is activated (Vehicle passing over a loop).

### Self-Test



**Self-Test Mode**

Self-test mode is for bench checks **ONLY!** Operator **MUST** be disconnected from the gate. The operator will continually cycle the gate.



**Normal Mode**

The jumper must be set at normal mode for normal operator function.

**Limit/Alarm Plug P3 Terminal**

**10-Pin UL 325 Removable Terminal**

See pages 27-29.

**Single Channel Low Current Draw Plug-In Loop Detectors**

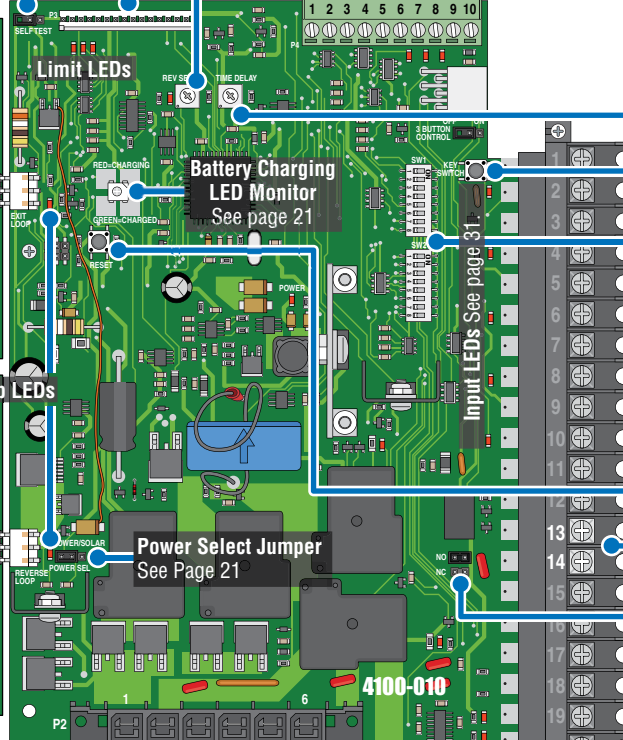
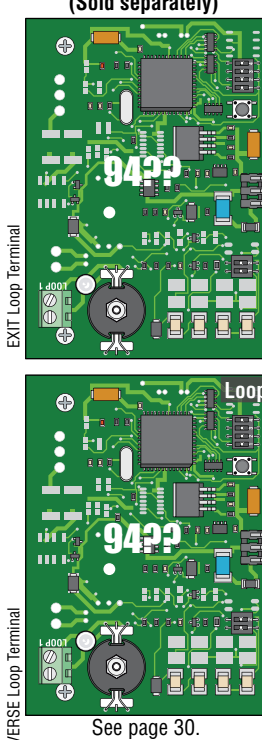

### Reverse Sensor

Adjust reversing sensitivity for the open **AND** close direction of the operator, See page 26.

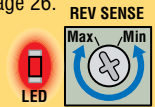

### Auto-Close Timer

Auto-close timer (when turned on) SW 1, switch 2.

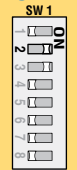

### Time Delay:

Adjust from 1 second (full counter-clockwise) to approximately 23 seconds (full clockwise).



**Key Switch:** Cycles the operator when pressed. Will use Auto-Close timer when turned ON.



**Note:** When powering up operator, the key switch **MUST** be pressed **AFTER** DC power switch is turned ON to power up operator.

### DIP-Switches

Set the DIP-switches on the circuit board to the desired setting. See switch-settings on next 2 pages.

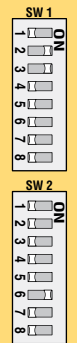

**Reset Button:** Press after changing a DIP-switch setting on the board or if board locks up during operation.



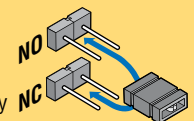

### Board Relay

Dry relay contacts (terminals 13-14) can be set for Normally Open (NO) or Normally Closed (NC) operation by placing the relay shorting bar on the N.O. or N.C. pins respectively. SW 1, switches 6 and 7 must be set to control relay. See next page for descriptions.



## 3.2 DIP-Switch Settings for 4100 Circuit Board

The two DIP-switches located on the circuit board are used to program the operator to operate in various modes and to turn on or off various operating features. Whenever a switch setting is changed, reset button must be pressed for the new setting to take affect. See next page for more information about DIP-switches.

SW 1 (Top 8 DIP Switches)			
Switch	Function	Setting	Description
1	Operator Opening Direction	Opening direction using <b>ON</b> setting.  	Opening direction using <b>OFF</b> setting. Changes direction operator will cycle open upon initial AC power up and open command.
2	Auto-Close Timer	OFF	Auto-close timer is <b>OFF</b> . Manual input required to close an open gate.
		ON	<b>Normal Setting</b> . Auto-close timer is <b>ON</b> . Adjustable from 1-23 seconds.
3	Not Used	<b>OFF</b>	Switch <b>MUST</b> be turned <b>OFF</b> for Solar.
4	Reverses Gate	<b>OFF</b>	<b>Normal Setting</b> . Input to main terminal 10 and reverse loop will <b>reverse</b> gate during <b>close</b> cycle.
	Stops Gate (Slide gates)	ON	Input to main terminal 10 and/or reverse loop will <b>stop</b> gate during <b>close</b> cycle – gate will <b>continue to close</b> after input to main terminal 10 and/or reverse loop are cleared (Helps prevent tailgating).
5	Quick-Close Timer Override (Slide gates)	<b>OFF</b>	<b>Normal Setting</b> . Quick close feature is <b>OFF</b> . Auto-Close timer functions normally.
		ON	Quick close feature is <b>ON</b> . Opening gate will stop and close as soon as all reversing inputs (Reverse loops, photo sensors) are cleared regardless of the distance the gate has opened. Any Auto-Close timer setting overrides to 1 sec.
6 and 7	Relay: Main Terminals 13 and 14	6-OFF 7-OFF	<b>Normal Setting</b> . Relay activates when gate is at open limit.
		6-OFF 7-ON	Relay activates when gate is not closed.
		6-ON 7-OFF	Relay activates when gate is opening and open.
		6-ON 7-ON	Relay activates during opening and closing cycle.
8	Accessory Power	<b>OFF</b>	24 VDC 500 mA <b>Constant power</b> for accessories connected to main terminal 12.
		ON	<b>DO NOT USE</b> for Solar.

 Setting **MUST** be used

SW 2 (Bottom 8 DIP Switches)			
Switch	Function	Setting	Description
1 and 2	Select Operator Type	<b>1-OFF 2-OFF</b>	<b>Slide Gate Operator</b>
		1-OFF 2-ON	<b>DO NOT USE</b> for the 9024. Swing Gate Operator
		1-ON 2-OFF	<b>DO NOT USE</b> for the 9024. Barrier Gate Operator
		1-ON 2-ON	<b>DO NOT USE</b> for the 9024. Overhead Gate Operator
3	Input Power Failure Mode	<b>OFF</b>	Gate <b>operates normally</b> using <b>ONLY</b> battery back-up power or <b>Solar input power</b> .
		ON	<b>DO NOT USE</b> for Solar. Gate <b>fully opens/shuts down until AC power</b> is restored.
4	Reverse/Shadow Input	<b>OFF</b>	Main terminal 10 is a REVERSE input.
		ON	<b>DO NOT USE</b> for the 9024. Main terminal 10 is a SHADOW loop (Swing gates <b>ONLY</b> )
5	Overlapping Dual Gates	<b>OFF</b>	Switch 5 <b>MUST</b> be turned <b>OFF</b> for the 9024.
		ON	<b>DO NOT USE</b> for the 9024. Overlapping gates <b>ARE</b> used (Dual swing gates <b>ONLY</b> ). Secondary gate starts to open a few seconds before primary gate starts.
6	Circuit Board Power Management	OFF	<b>DO NOT USE</b> for Solar. For <b>115/230 VAC</b> input power. Board has <b>Constant power</b> .
		ON	Used for <b>Solar</b> input power. Board <b>Minimizes power</b> when not in use. All terminals shut down power except <b>main terminals 1, 2, 3</b> and <b>loop detector ports</b> .
7 and 8	Not Used	<b>OFF</b>	Switches 7 and 8 <b>MUST</b> be turned <b>OFF</b> for the 9024.

## 3.2 DIP-Switches Continued

### SW-1 Switch

(Top 8 switches on circuit board)

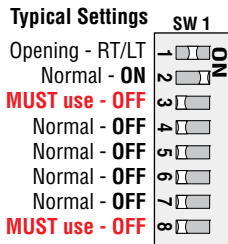

**Switch 1 - Operator Opening Direction:** **Must OPEN** the operator's gate upon initial AC power up and open command. If the first open command begins to close the gate, turn AC power off and reverse this switch.

**Switch 2 - Auto-Close Timer:** Turns the auto-close timer on or off. If auto-close is ON, maximum time that can be set for is approximately 23 secs. If auto-close is OFF, an open gate will not close until a manual input is received.

**Switch 3 - EXIT Loop Port Output / Full Open Input:** This switch **MUST** be turned **OFF** when using solar power. **DO NOT** turn this switch ON. **DO NOT** wire any devices to main terminal 4.

**Switch 4 - Reverse / Stop Gate:** Determines if an input to main terminal 10 (Photo Sensors) **AND/OR** reverse loops will reverse **OR** stop a **CLOSING** gate.

A tailgating vehicle **can activate** main terminal 10 (Photo sensors) and/or reverse loops **while** the gate is in the closing cycle from the previous vehicle's authorized entry:

If switch 4 is turned **OFF** (Reverse), the closing gate that gets activated by a tailgating vehicle will reverse back to the open position, possibly allowing the tailgating vehicle **unauthorized entry while the gate is reversing back to the open position.**

If switch 4 is turned **ON** (Stop), the closing slide gate that gets activated by a tailgating vehicle will stop, partially or completely blocking the pathway, **NOT** allowing the tailgating vehicle to enter without proper authorization. The slide gate will not move until all sensors are clear, usually forcing the tailgating vehicle that activated the sensors to back away from the gate. The slide gate will then continue until closed, helping prevent the tailgating vehicle from unauthorized entry.

**Switch 5 - Quick-Close Timer Override:** Turning the quick-close feature ON will cause an **opening gate** to stop and close when the reverse loops and/or photo sensors have been cleared by a vehicle no matter how far the gate has opened (Useful when opening a long gate to reduce gate cycling time). This will also override the auto-close timer setting to close the gate after 1 second, regardless of the time that has been set for the auto-close timer.

**Switches 6-7 - Relay:** These work in conjunction with each other and determine when the relay on the board (main terminals 13-14) will be activated. This relay can be used as a switch for various functions such as illuminating a warning light when the gate is moving, or turning on a green light when the gate is full open.

**Switch 8 - Accessory Power:** This switch **MUST** be turned **OFF** when using solar power. A maximum of 500 mA of constant power is supplied to any accessory connected to main terminals 11 and 12.

**DO NOT** turn this switch ON.

### SW-2 Switch

(Bottom 8 switches on circuit board)

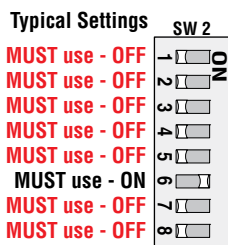

**Switches 1-2 - Select Operator Type:** These switches **MUST** be turned **OFF** for the Model 9024. They indicate the type operator that will be used with the circuit board.

**Switch 3 - Input Power Failure Mode:** This switch **MUST** be turned **OFF** when using solar power. In the event that the solar panel cannot charge the batteries and battery power gets depleted through normal gate cycling, gate will fully open and operator will shut down. When solar panel power begins charging the batteries again, gate will close. Note: A heavy gate may not completely open during the FINAL opening cycle after the battery power has been depleted.

**DO NOT** turn this switch ON.

**Switch 4 - Reverse Input:** This switch **MUST** be turned **OFF** for the 9024. Main terminal 10 is a reverse input. **DO NOT** turn ON.

**Switch 5 - Overlapping Dual Gates:** This switch **MUST** be turned **OFF** for the 9024. **DO NOT** turn ON for the 9024.

**Switch 6 - Circuit Board Power Management:** This switch **MUST** be turned **ON** when using solar power. It minimizes the power drain by the circuit board. When the gate has been closed for 5 min. or held open for 5 min., circuit board will power down to conserve power. Main terminals 1, 2, 3 and loop detector ports will remain powered up. An input from one of these connections will power up the circuit board again.

**DO NOT** turn ON when using solar power.

**Switches 7-8 - Not Used:** These switches **MUST** be turned **OFF** for the Model 9024. **DO NOT** turn ON.



## 3.3 Limit Switches

### Open and Close Limits **MUST** be Set

The operator normally stops a cycling gate using the open and close limits. If the limits have not been set, the gate could continue beyond its full open and close positions, damaging the gate and operator. **DO NOT** allow this to occur!

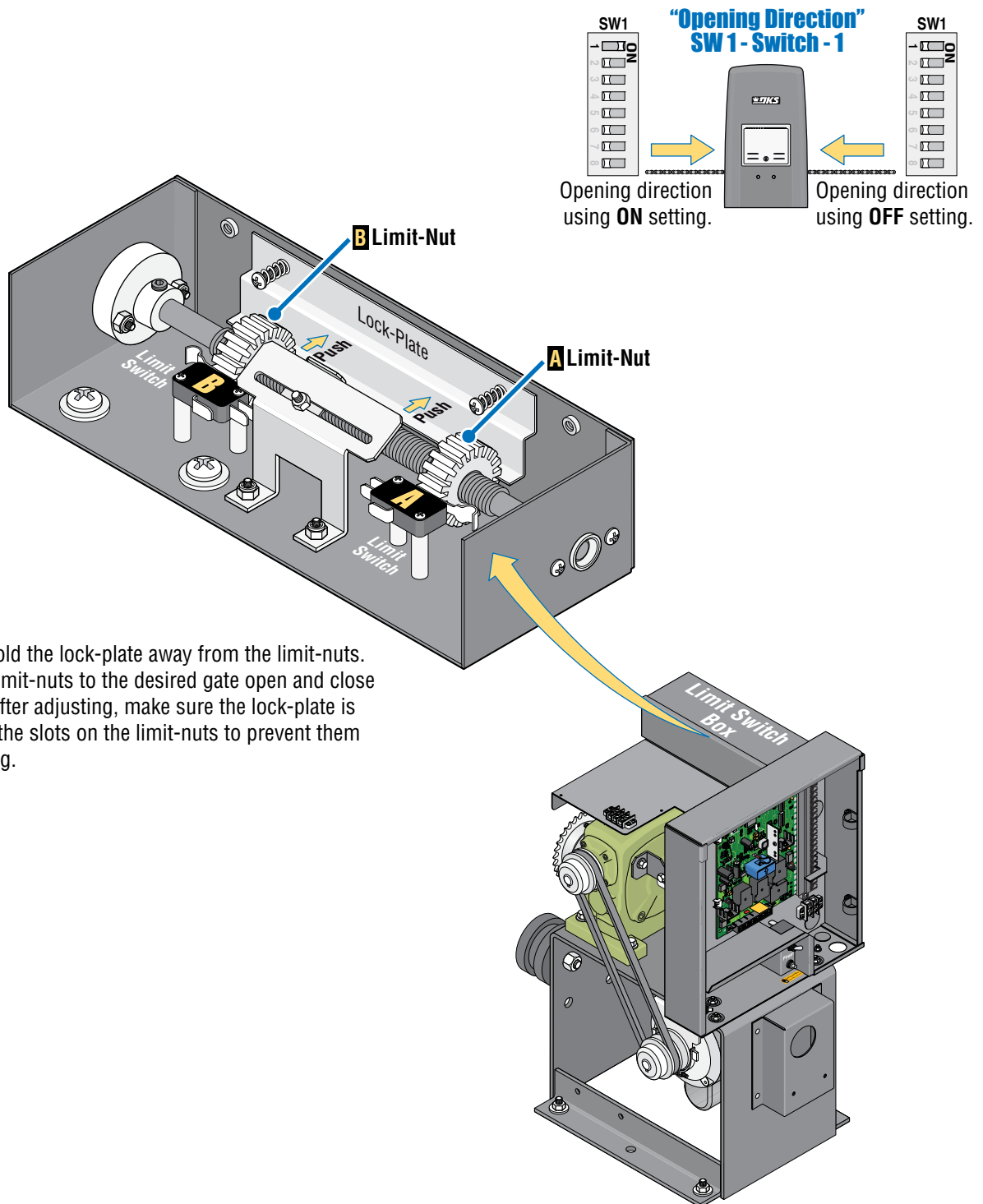

Push and hold the lock-plate away from the limit-nuts. Rotate the limit-nuts to the desired gate open and close positions. After adjusting, make sure the lock-plate is engaged in the slots on the limit-nuts to prevent them from rotating.

**Note:** Limit/Alarm Plug P3 **MUST** be connected to the circuit board or operator will **NOT** function.

## 3.4 Inherent Reverse Sensor Adjustment

This vehicular gate operator is equipped with an inherent adjustable reversing sensor (Type A) used as the primary entrapment protection system according to UL 325 standards. **The gate will reverse direction after “physically” encountering an obstruction in either the opening or closing gate cycle.**

If the Auto-Close Timer (DIP-switch SW 1, switch 2) is ON and the gate physically encounters an obstruction during the **CLOSING** cycle, it will reverse to the open position and **HOLD** the gate at this position (Soft shutdown condition). Another input command is needed before the gate will reset and close again.

For the reverse system to function correctly, the gate must be properly installed and work freely in both directions and the limit switches must be properly adjusted before adjusting these sensors. The ideal adjustment will allow the operator to move the gate through its entire travel cycle without reversing, but will reverse upon contact with an obstruction with no more than 40 Lbs of force. This force can be measured with a gate scale.

**CAUTION: Keep pedestrians and vehicles clear of the gate while adjusting and testing sensors!**

- 1 Press the “**Push to Operate**” button to **OPEN** the gate.

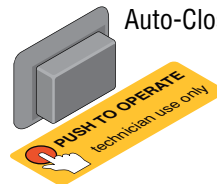

Note: “**Push to Operate**” button will use Auto-Close timer if turned ON.

- 2 While gate is opening, slowly rotate the reverse sensor clockwise until the LED lights up and the gate reverses direction. Rotate the reverse sensor back counter-clockwise approximately 1/8 turn to decrease the sensitivity (LED will turn off).

Note: The LED will turn on briefly when AC power is turned on.

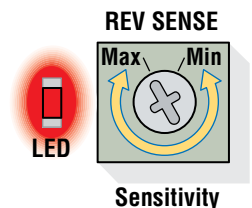

- 3 Press the “**Push to Operate**” button and **CLOSE** the gate. Make sure the gate closes completely. If it reverses and opens (LED will turn on), rotate the reverse sensor counter-clockwise a little more to decrease the reverse sensitivity (LED will turn off).

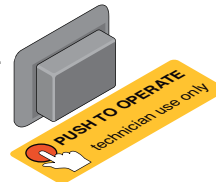

Cycle the gate a few times to be sure that it cycles completely in both directions, adjusting the sensor as necessary.

**Safety Note:** The LED will remain ON after a cycling gate gets obstructed during normal operation to indicate that the reverse sensor has been tripped. Always check the gate area for possible obstructions before putting operator back in service.

### Test the operator reversing sensitivity:

Place an immobile object along the gate path, allowing the gate to strike it while in the **open** and **close** cycles. The gate must reverse direction after striking the object. If it does not, increase the reverse sensitivity and repeat this testing until the correct sensitivity has been achieved in **BOTH** directions. The operator will assume a soft shutdown (Hold the auto-close timer) after striking and reversing the gate which will require pressing the “**Push to Operate**” button to cycle the operator again.



# SECTION 4 - ENTRAPMENT AND SAFETY PROTECTION

## Secondary Entrapment Protection Devices:

In addition to the inherent reversing sensor system, the Model 9024 has a UL 325 terminal for the connection of **photo sensors**-Type B1 and **reversing edges**-Type B2 secondary entrapment protection devices required by UL 325 standards. Entrapment protection devices **must be installed** to reduce the risk of injury. Install these devices where the risk of entrapment or obstruction exists while the gate is moving. The Model 9024 offers numerous options to meet your specific needs. The next 2 pages show wiring and typical positioning of the entrapment protection devices but specific installations will vary.

## 4.1 UL 325 Terminal Description

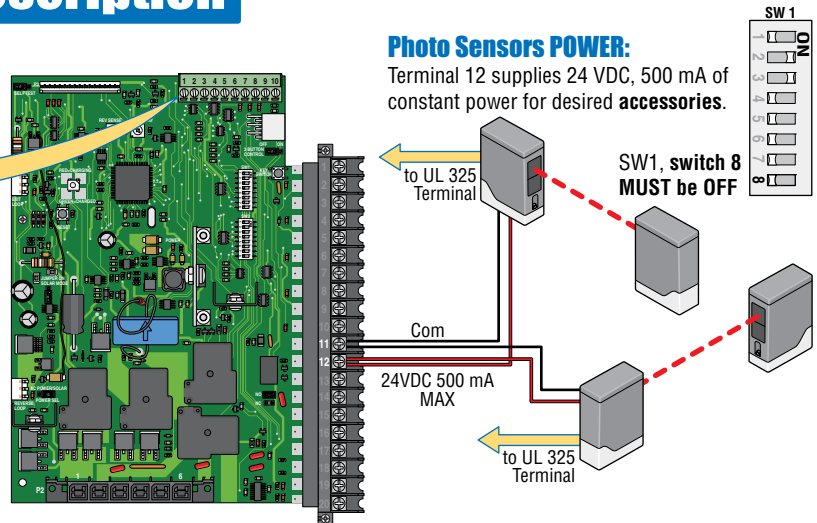
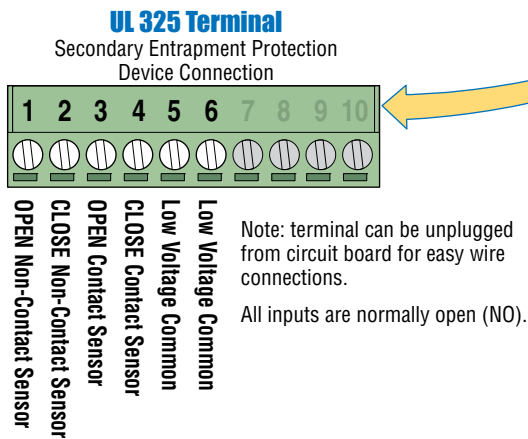

**1 OPEN Non-Contact Sensor (Photo Sensor):** Obstructed opening-direction photo beam will stop the gate **during the opening-direction only**. Gate will resume the open cycle when the obstructed photo beam has been cleared.

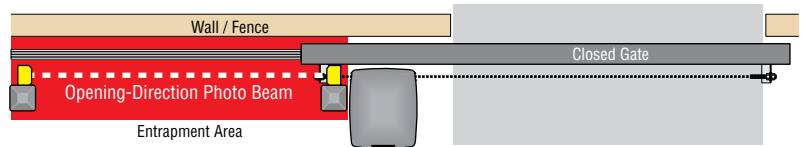

**2 CLOSE Non-Contact Sensor (Photo Sensor):** Obstructed closing-direction photo beam will stop the gate **during the closing-direction only**. Gate will resume the close cycle when the obstructed photo beam has been cleared.

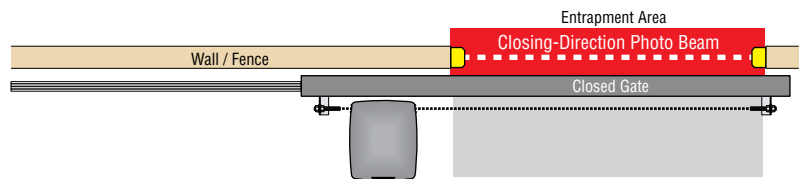

**3 OPEN Contact Sensor (Reversing Edge(s)):** Obstructed opening-direction reversing edge(s) will stop, then reverse the gate to the close position **during the opening-direction only**.

- After the gate reverses to the full close position, any opening input will cycle the gate again. Note: If the gate is opening by a time clock and an opening-direction reversing edge gets obstructed, the gate will return to the closed position and another input (automatic exit loop, reverse loop, etc.) is needed to cycle the gate open again.

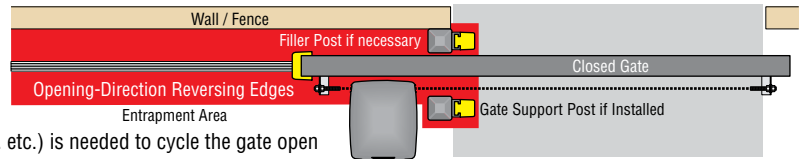

- When the **opening-direction** reversing edge(s) gets obstructed and the gate is traveling back to the close position and the **closing-direction** reversing edge gets obstructed, the gate will **stop** and enter a soft shutdown condition (See page 34).

**4 CLOSE Contact Sensor (Reversing Edge):** Obstructed closing-direction reversing edge will stop, then reverse the gate to the open position, **during the closing-direction only**.

- After the gate reverses to the open position, the timer will automatically close the gate (if it is turned on). If the closing-direction reverse edge is activated a **second** time prior to the gate reaching the close position, the operator will **stop** and enter a soft shutdown condition (See page 34).
- When the **closing-direction** reversing edge gets obstructed and the gate is traveling back to the open position and the **opening-direction** reversing edge gets obstructed, the gate will **stop** and enter a soft shutdown condition (See page 34).

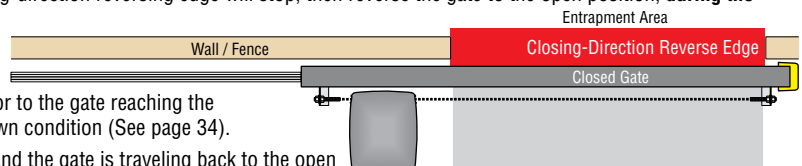

**5 & 6 Low Voltage Common:** Common terminals for all the secondary entrapment protection device inputs.

# 4.2 Secondary Entrapment Protection Device Locations

## Typical UL Photo Sensor mounting height and distance away from gate.

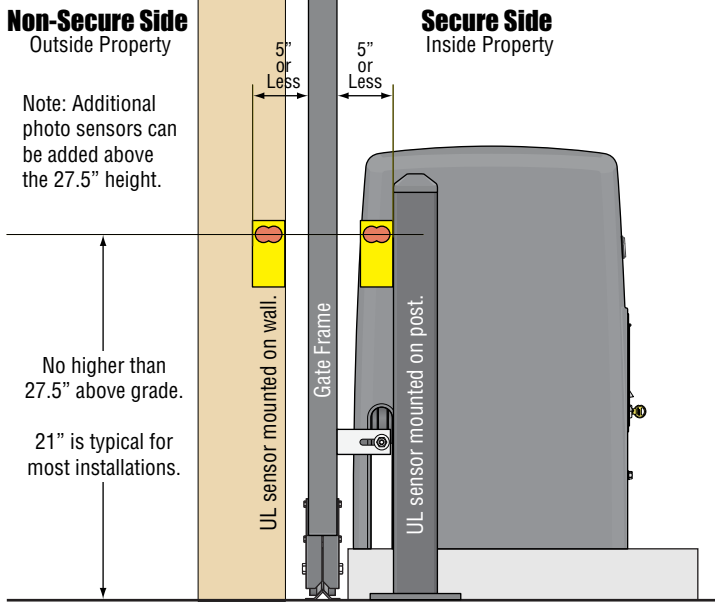
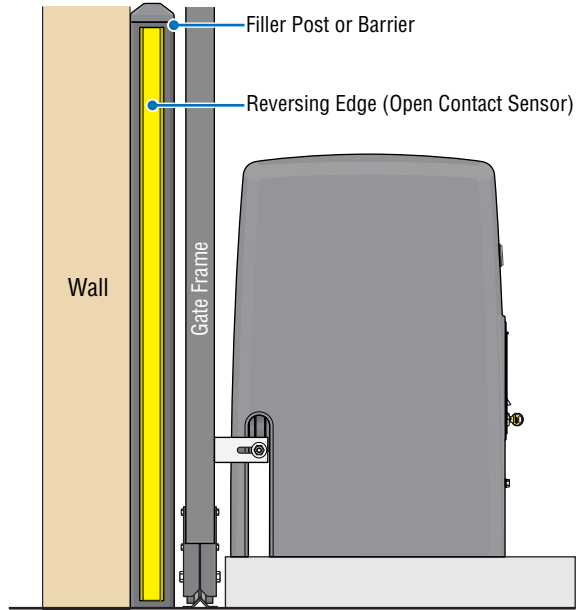

Photo sensors may be installed on either side of gate frame, as close as practical to the gate but no further away than 5".

## If the distance between the gate and wall is greater than 2 1/4".



A filler post or barrier may need to be installed between the gate and wall area to reduce the distance to 2 1/4" or less. A reversing edge should be installed on the post or barrier for safety (See page 3 for more information).

## Photo Sensors (With Filler Post and Reverse Edge) Sample Setup

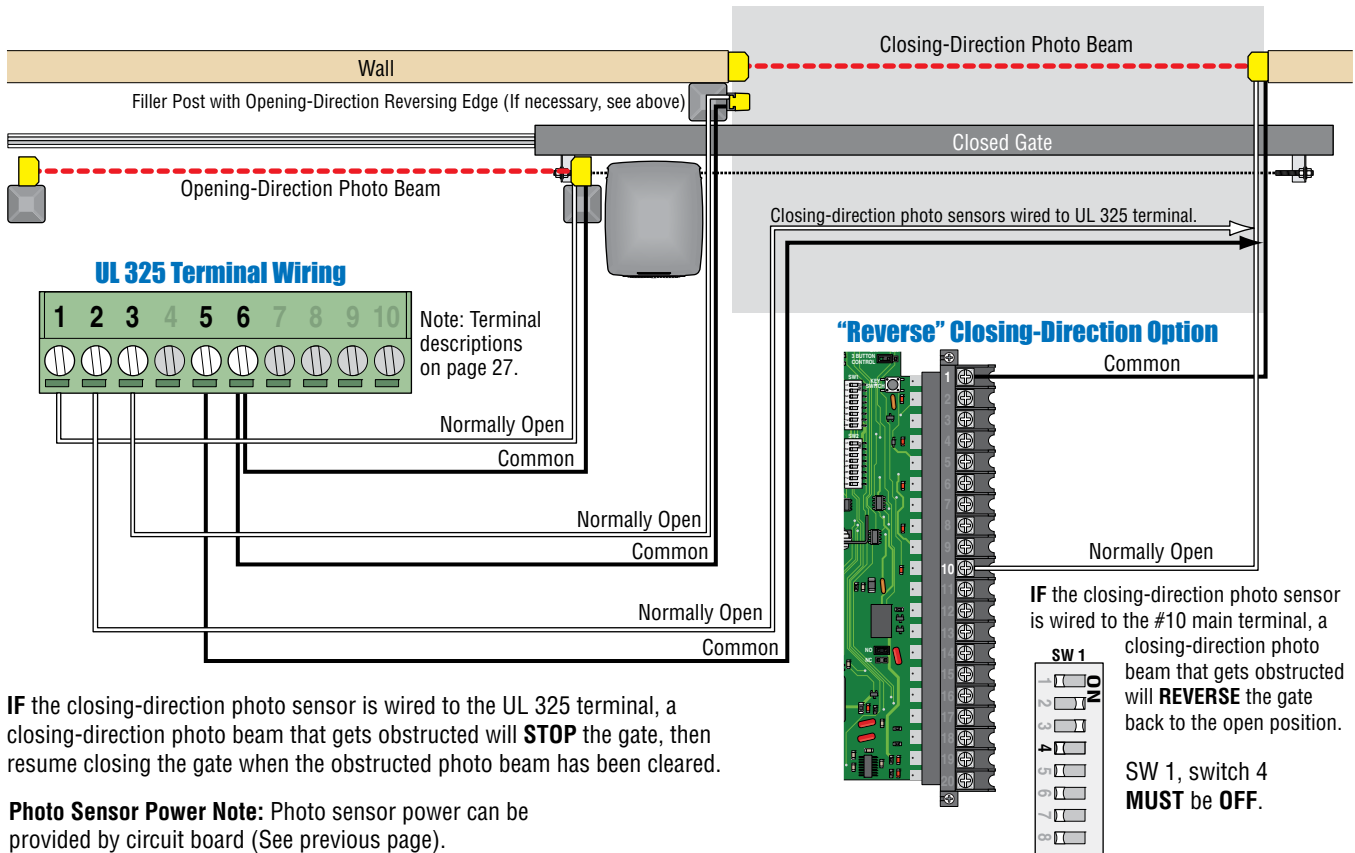

IF the closing-direction photo sensor is wired to the UL 325 terminal, a closing-direction photo beam that gets obstructed will **STOP** the gate, then resume closing the gate when the obstructed photo beam has been cleared.

**Photo Sensor Power Note:** Photo sensor power can be provided by circuit board (See previous page).

# Wireless Reverse Edge Sample Setup - Single Receiver

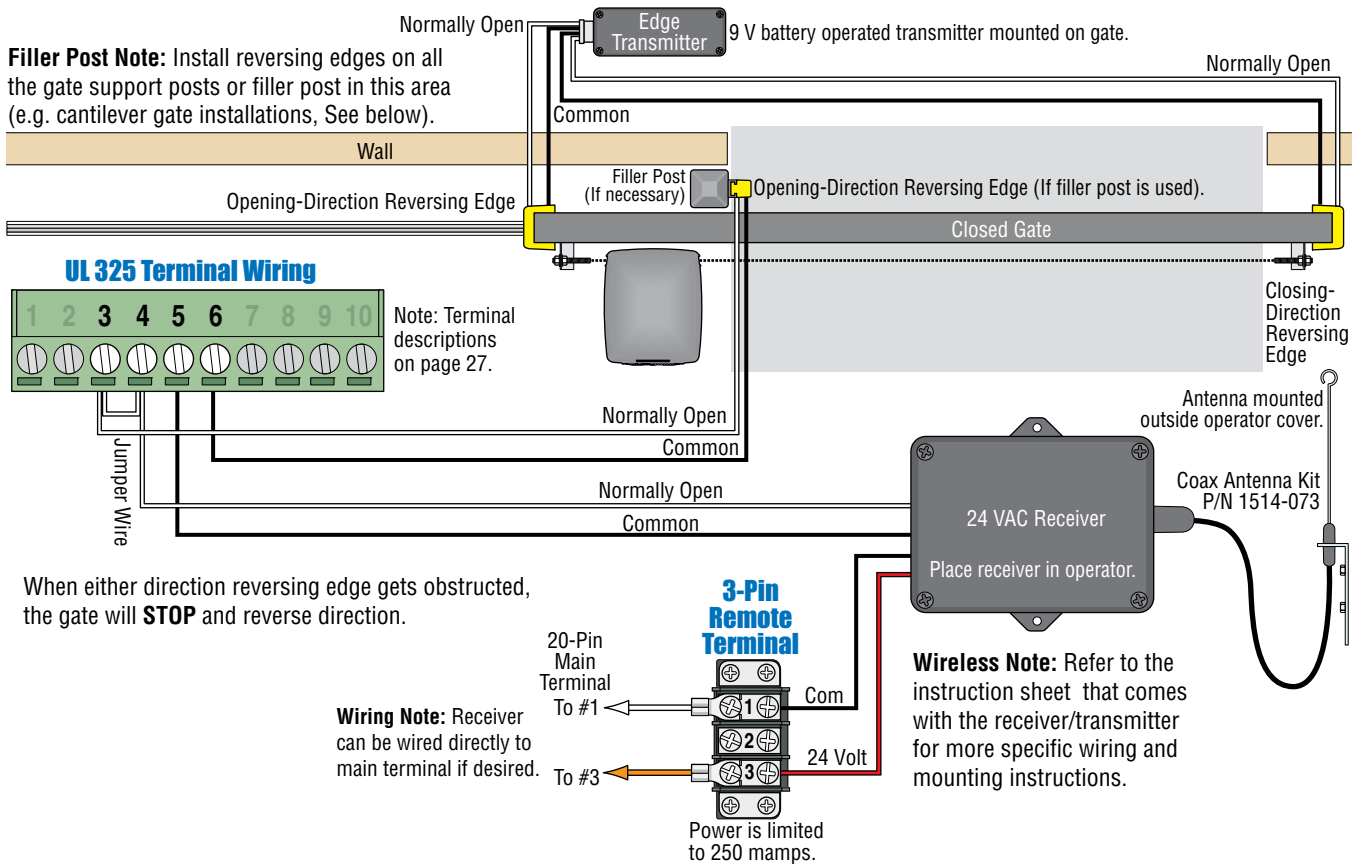

# Photo Sensor and Wireless Reverse Edge Sample Setup

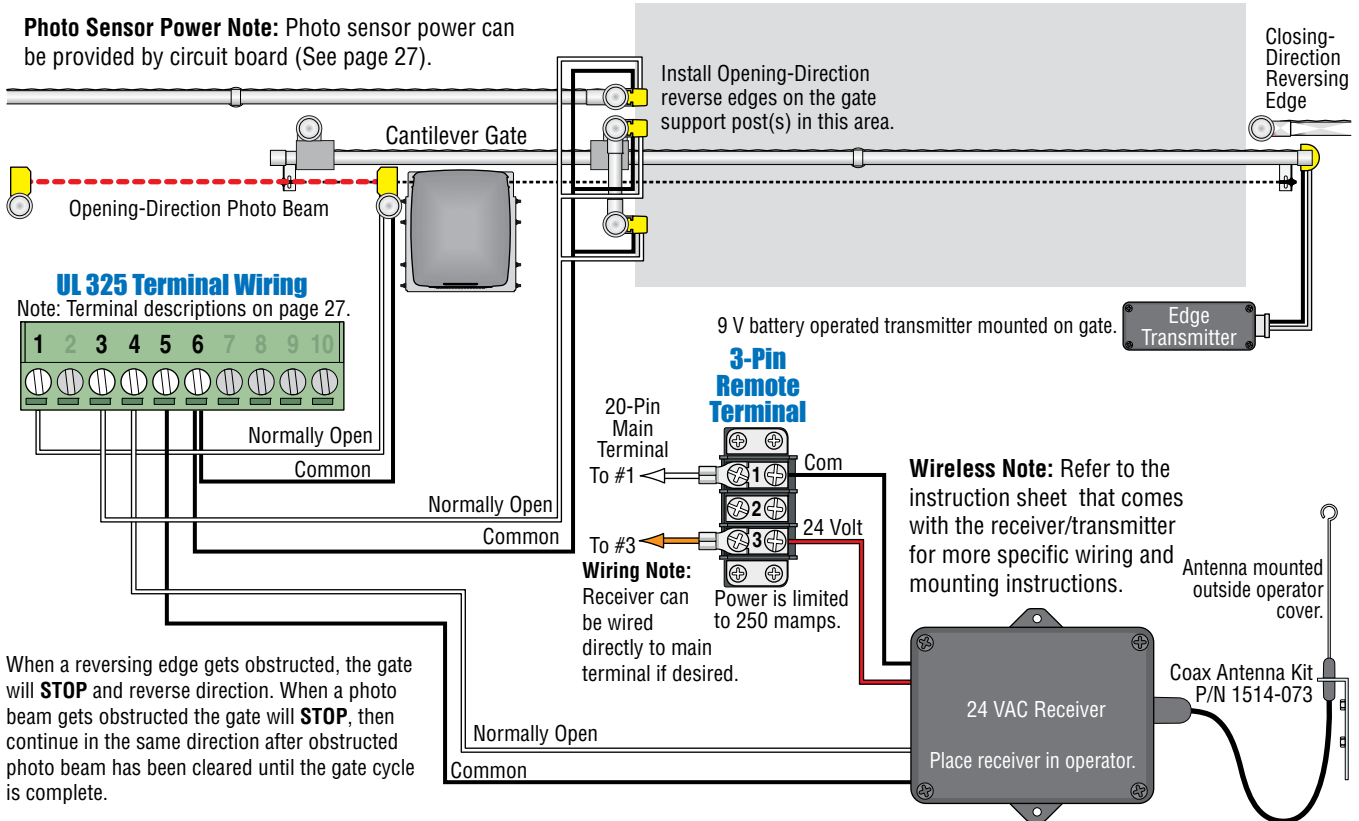

# 4.3 Loop Detector Wiring

To help protect the operator from accidentally closing on vehicles in the gate's path, DoorKing highly recommends that loops and loop detectors be installed. Loops are laid underneath, cut into asphalt or concrete driveways or buried beneath gravel and earth driveways. A loop detection system will sense a vehicle like a metal detector and send a signal to the gate operator preventing the gate from automatically opening or closing on a vehicle when it is in the gate's path. DoorKing recommends that a licensed installer perform this work.

DoorKing offers a free "Loop and Loop-Detectors Information Manual" PDF located at DoorKing's web site for more information. [www.doorking.com](http://www.doorking.com)

## Reverse Loops

Reverse loops are placed on each side of the gate to prevent the gate from closing on a vehicle in the gate's path. They will stop or reverse the cycling of the gate while a vehicle is in or near the gate's pathway.

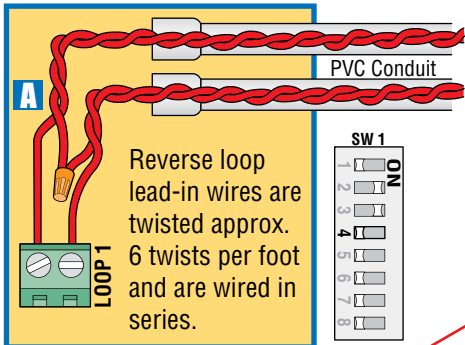

Note: SW 1, switch 4 **must** be set for the reverse loops. See pages 23 and 24 for more information about SW 1, switch 4 ON/OFF options.

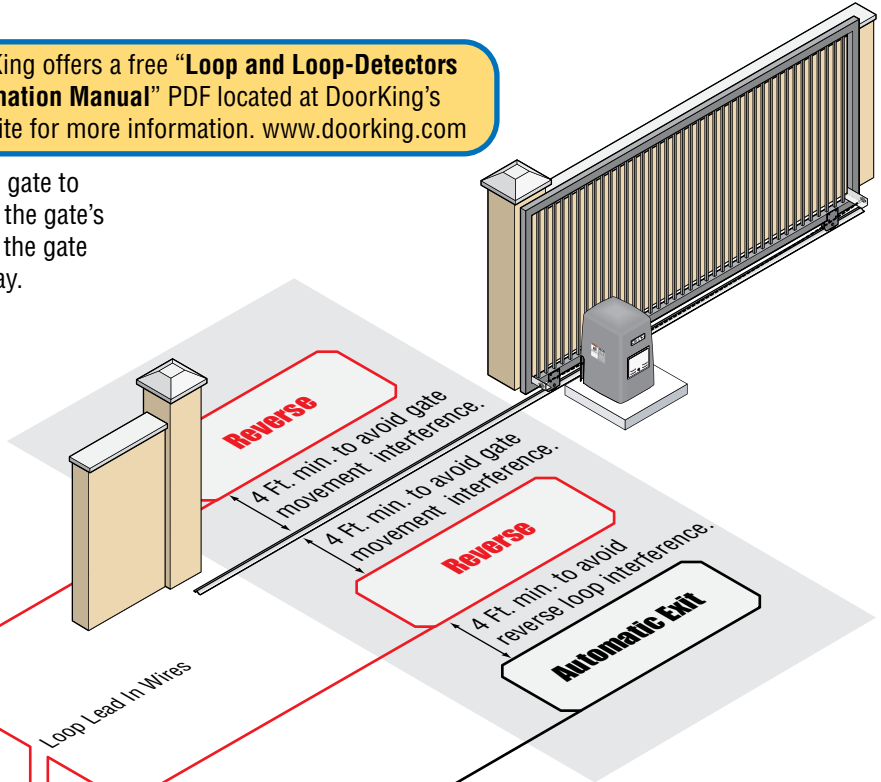

## Automatic Exit Loop

Automatically opens the gate for exiting vehicles without having to use a transmitter or keypad. The exit loop can be placed a minimum of 4 feet away from the reverse loop or far enough away from the gate so the gate has started opening or even completely opened by the time you drive up to it (Free exit).

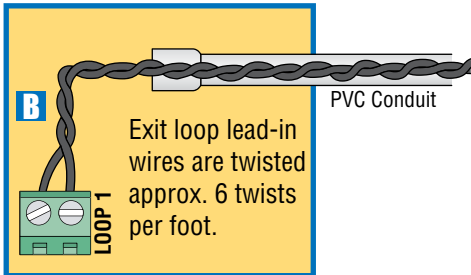

Note: Loop detector wiring is shown for DoorKing low current draw plug-in loop detector (P/N 94??-010 Single Channel). If third party loop detectors are used, They **MUST** be low current draw detectors. Refer to the installation instructions supplied with those detectors for wiring and separate power instructions.

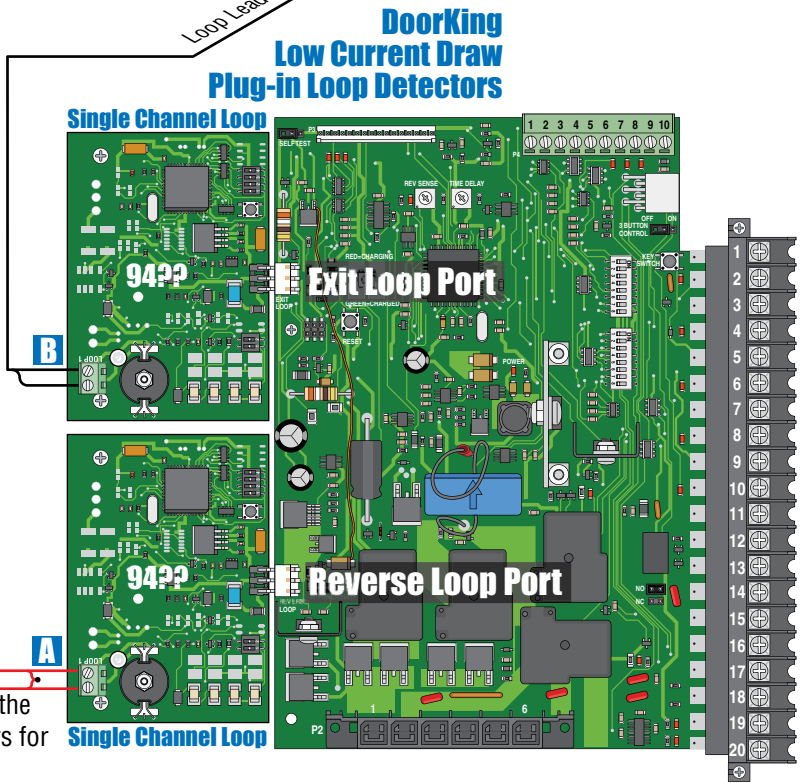

# SECTION 5 - MAIN TERMINAL WIRING

## 5.1 Terminal Descriptions

### UL 325 Terminal

See pages 27 - 29

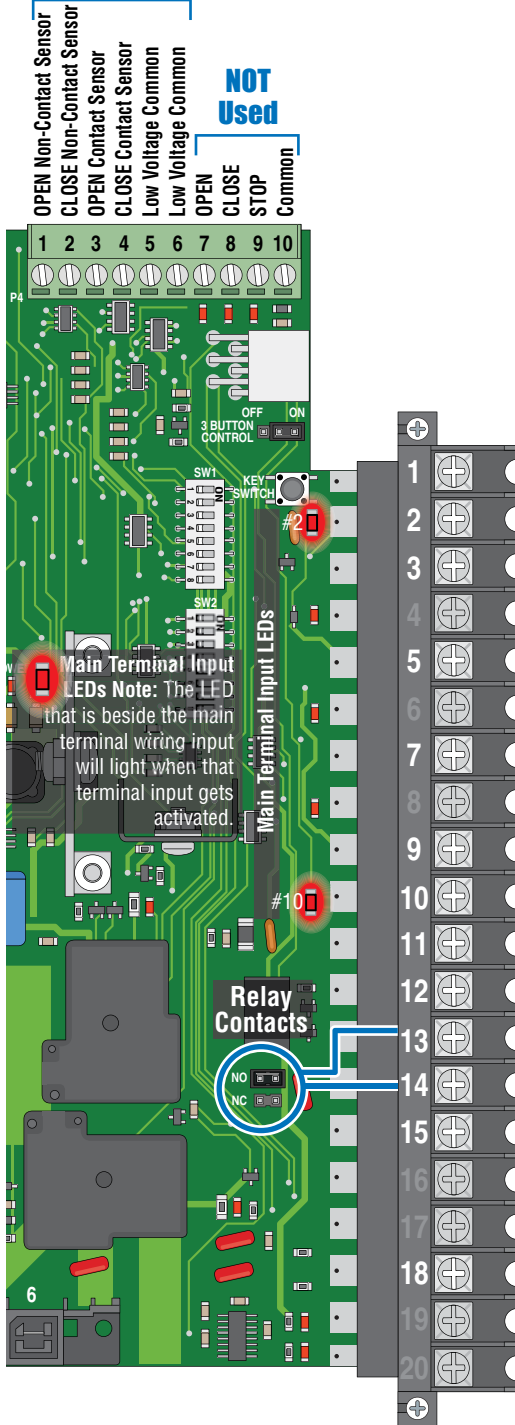

20-Pin Main Terminal

Terminals 1, 2 and 3 are ALWAYS powered up. Even when circuit board has powered down to manage the power drain on the batteries.  
**ONLY** connect **opening devices** to terminal 2.

This input ONLY functions when gate is fully opened or in the closing cycle.

- When gate is closing: SW 1, switch 4 is OFF, an input to main terminal 10 (eg: photo beam gets obstructed) will reverse and open the gate. **Note:** If the auto-close timer is ON, when gate reaches the open position, timer will time out and close the gate.
- When gate is closing: SW 1, switch 4 is ON, an input to main terminal 10 (eg: photo beam gets obstructed) will stop the gate, then continue to close the gate when input is clear (Used to help prevent tailgating vehicles from unauthorized entry). See page 24 for more information.



SW1, switch 8 MUST be OFF: 24-VDC 500 mA constant power can be provided for desired accessories wired to terminal 12.  
**DO NOT** turn ON SW1, switch 8.

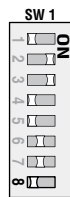
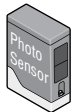

Operation of relay is dependent on setting of SW 1, switches 6 and 7. **Relay contacts** can be set for Normally Open (NO) or Normally Closed (NC) operation.  
**Contact rating is 1 amp maximum at 24-volts DC.**

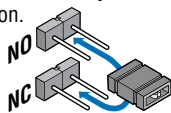



# 5.2 Control Wiring

## UL 325 10-Pin Terminal

### UL 325

See pages 27 - 29

- OPEN Non-Contact Sensor
- CLOSE Non-Contact Sensor
- OPEN Contact Sensor
- CLOSE Contact Sensor
- Low Voltage Common
- Low Voltage Common

**Not Used**

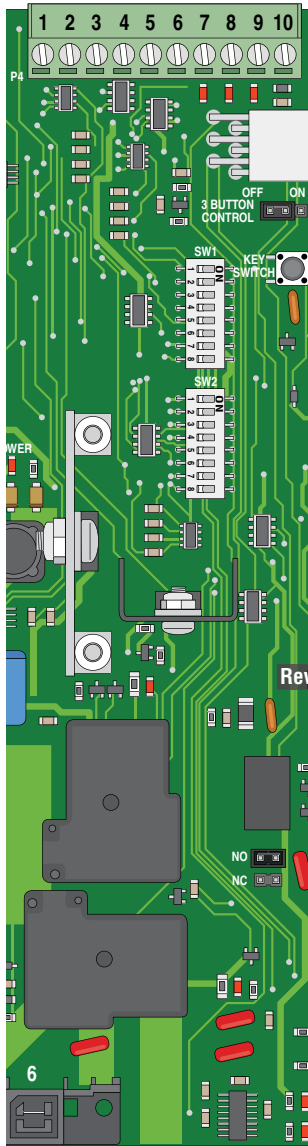

**Important:** Controls intended for user activation must be located at least ten (10) feet away from any moving part of the gate and where the user is prevented from reaching over, under, around or through the gate to operate the controls. Emergency access controls only accessible by authorized personnel (e.g., fire, police, EMS) may be placed at any location in the line-of-sight of the gate.

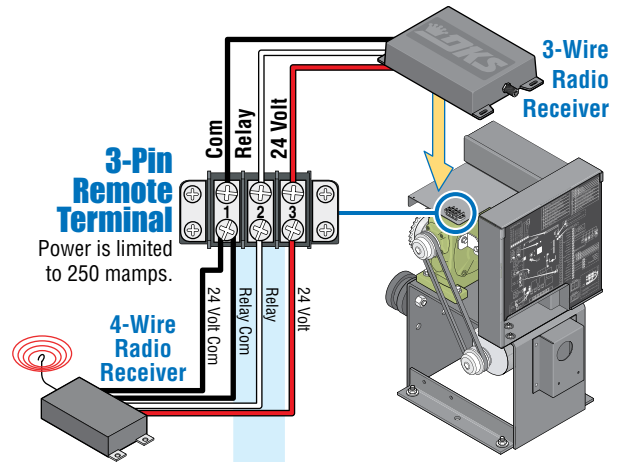

**#2 Terminal Note:** ONLY connect OPENING devices to terminal #2 to open the gate.

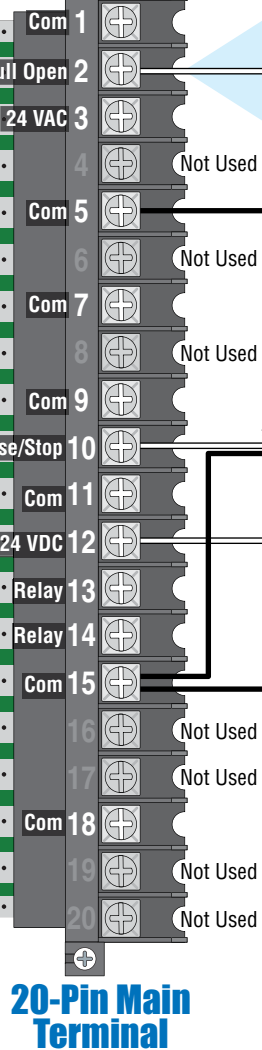

Note: All stand-alone and telephone entry devices must use a separate power source.

#10 N.O.

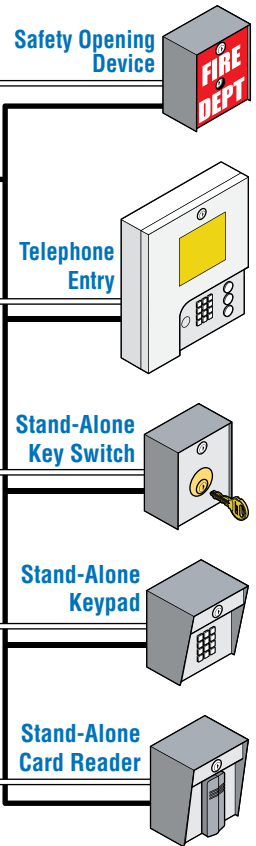
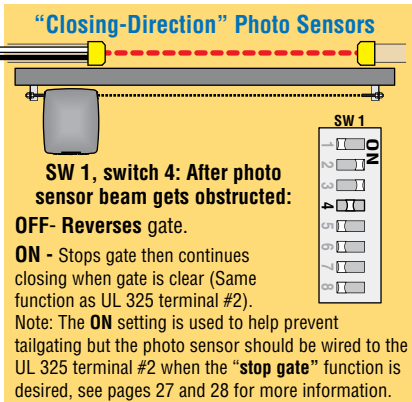

### Accessories Power

24 VDC, 500 mA max accessories can be powered by main terminal 12.

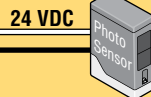

SW 1, switch 8 **MUST** be OFF.

# SECTION 6 - OPERATING INSTRUCTIONS

## IMPORTANT SAFETY INSTRUCTIONS

**WARNING** - To reduce the risk of injury or death:

1. READ AND FOLLOW ALL INSTRUCTIONS.
2. Never let children operate or play with gate controls. Keep the remote control away from children.
3. Always keep people and objects away from gate. **NO ONE SHOULD CROSS THE PATH OF THE MOVING GATE.**
4. Test the operator monthly. The gate **MUST** reverse on contact with a rigid object or stop or reverse when an object activates the non-contact sensors. After adjusting the force or the limit of travel, retest the gate operator. Failure to adjust and retest the gate operator properly can increase the risk of injury or death.
5. Use the emergency release only when the gate is not moving and power has been shut-off.
6. **KEEP GATES PROPERLY MAINTAINED.** Read the owner's manual. Have a qualified service person make repairs to gate hardware.
7. The entrance is for vehicles only. Pedestrians must use separate entrance.
8. **SAVE THESE INSTRUCTIONS.**

## 6.1 Operator Controls and Resets

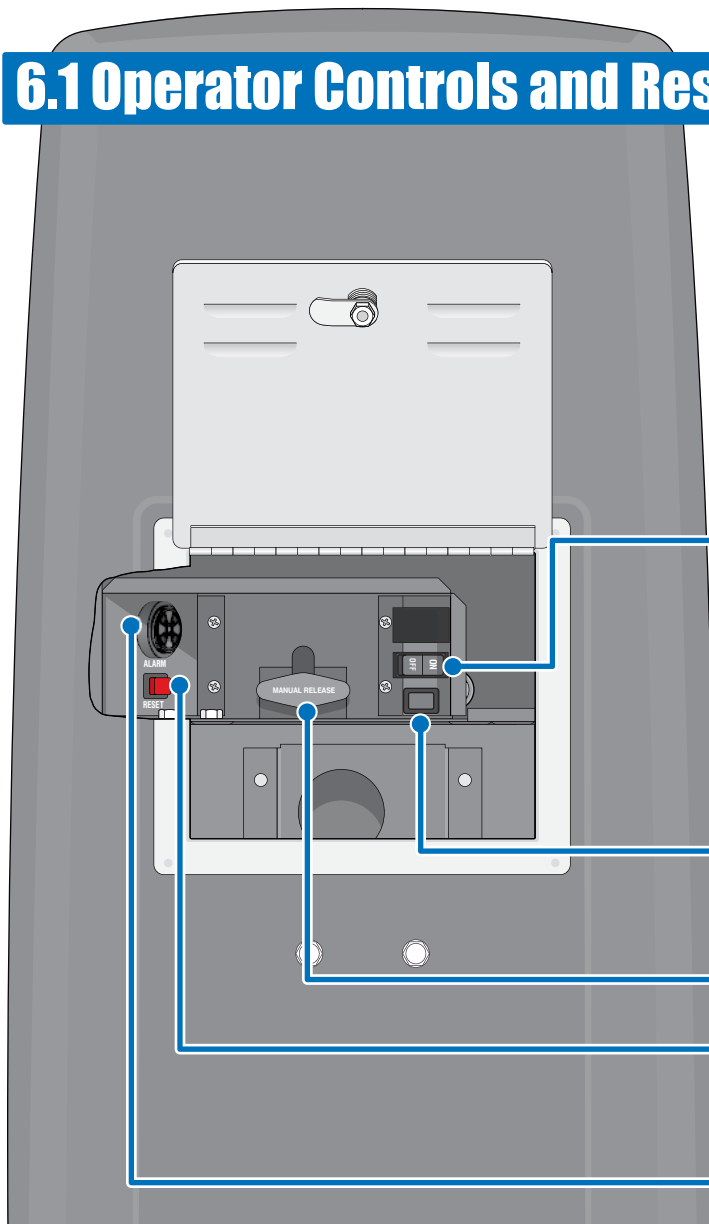
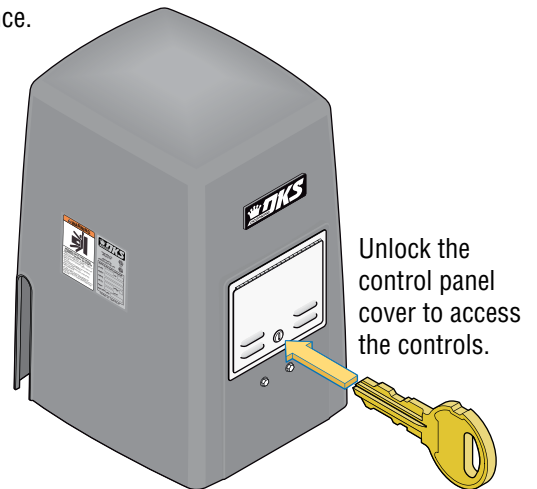

**DC Power Switch** - Powers the DC ON (toggle left) or OFF (toggle right).

**Note:** When powering up operator, the key switch  **MUST** be pressed (located on circuit board) **AFTER** DC power switch is turned ON to power up operator.

 **PUSH TO OPERATE**  
technician use only

**Push to Operate Button** - Push to cycle the operator. It will use the auto-close timer when turned ON to close the gate. Opens gate fully.

**Manual Release** - See page 35.

**Reset Button** - Push to turn off the entrapment alarm and to reset the operator after a **HARD** shutdown has occurred.

**Alarm Siren**



## 6.2 Shutdown Conditions

Under various entrapment conditions the operator will assume either a **soft** or **hard (alarm)** shutdown. To determine what type of reset action is required, you will need to understand how the different entrapment conditions affect the gate operator.

### Soft Shutdown (NO Alarm will Sound)

This occurs in various situations where the inherent or secondary entrapment protection devices have been activated. In a soft shutdown condition, the operator **will not** respond to any input that was present when the entrapment protection device sensed an obstruction. If the gate stops at the open position, the operator will not respond to the automatic close timer.

- **Example 1** - A time clock keys the gate open in the morning and an entrapment protection device senses an obstruction prior to the gate reaching the full open position. If the entrapment is sensed by the inherent system, the gate will reverse and run back to the closed position. The time clock input is still present, but the gate will not re-open.

Note: In some systems, the time clock input comes from the telephone entry system relay. This same relay may also provide open commands for a card reader, MicroPLUS transmitters and the visitor telephone entry. If so, these devices will also be disabled in a soft shutdown condition.

- **Example 2** - If the gate is closing and an entrapment protection device is activated, the gate will either stop or reverse and run back to the open position, depending upon if the secondary or inherent device was activated. The automatic close timer will not close the gate.
- **Example 3** - Vehicle arrives at exit loop and gate runs towards the open position. If the inherent entrapment protection gets activated during this opening cycle, the gate reverses and runs back to the closed position. After the inherent entrapment protection is cleared, if the vehicle is still present at the exit loop, a soft shutdown condition does not occur. The exit loop input provides an immediate reset of the operator and the gate will again run to the open position.

### Resetting a Soft Shutdown

In some conditions, a soft shutdown will reset as soon as the entrapment condition clears. For example, if a non-contact sensor (photocell) is sensing an obstruction, the operator will stop the gate and assume a soft shutdown condition. When the photocell clears, the operator will return to normal operation.

When the operator is in a soft shutdown, activation of any “intended input” will reset the operator. An “intended input” includes any command, any standard safety input and any loop input. Activating any of these inputs will reset the gate. At that point the gate will return to normal operation. If the gate is open, the automatic close timer will then time out and close the gate.

### Hard Shutdown (Alarm Activated)

**A hard shutdown condition occurs when: (1.) The inherent entrapment protection system (Type A) gets activated TWO consecutive times before the gate completes the open or close cycle. (2.) The reversing edge (Type B2) gets activated and reverses but before the gate completes the reverse cycle the inherent entrapment protection system (Type A) gets activated.**

- **Example of a Hard Shutdown** - The gate is closing and the inherent entrapment protection system senses an obstruction and causes the gate to reverse direction. As the gate begins to run in the open direction, a second obstruction is sensed prior to the gate reaching the full open position. Once the second obstruction has been sensed, the operator will stop, **the audio alarm will sound and all standard inputs are shut down** (including open commands, safety commands, loop inputs, etc.).
  - **To silence the alarm**, press the reset button or after 5 minutes, the audio alarm will shut off but will “chirp” every 5 seconds. This indicates that the operator is in a hard shutdown condition (The reset button must be pressed to reset the operator and stop the alarm “chirping”).

### Resetting a Hard Shutdown

The operator is in a hard shutdown condition when the audio alarm is sounding OR “chirping” every 5 seconds.

- Before resetting a hard shutdown, determine why the shutdown occurred. Inspect the gate for any obstructions along its path that could have activated the inherent entrapment sensing system. Inspect the gate and gate hardware.

**The audio alarm will sound for five minutes, or until the operator’s reset button is pushed. After (5) five minutes the alarm will “chirp every 5 sec.” and the hard shutdown condition will remain in affect until the reset button is pushed.**

Once the operator has been reset, an open or close command is needed to start the gate operator. Most activating commands will cause the gate operator to cycle to the open position. This includes activation of a key switch or open command and activation of an automatic exit loop. Activation of a close command will run the gate to the closed position.

Note: DoorKing operators have a built-in alarm reset push button mounted on the operator (See previous page for reset button location). Activating this button will return the gate operator to normal operation, but will not cycle the gate operator. A remote alarm/reset station (P/N 1404-080) can be mounted external of the gate operator provided that it is installed in the line-of-sight of the gate and gate operator.

## 6.3 Manual Gate Operation

**Caution:** Never attempt to manually operate any gate until you have verified that **ALL** power to operator has been shut-off.

### 1 Pull Manual Release Handle

Pull straight **OUT** as far as possible and then **UP**.

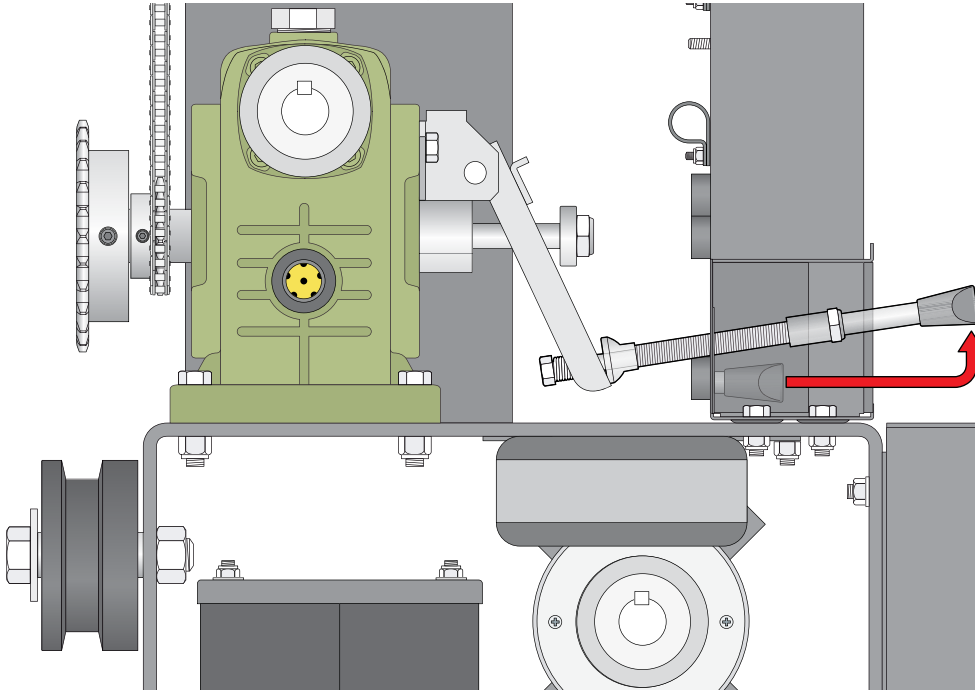

### 2 Release Handle

With handle in UP position, slide back down to lock it in manual release position.

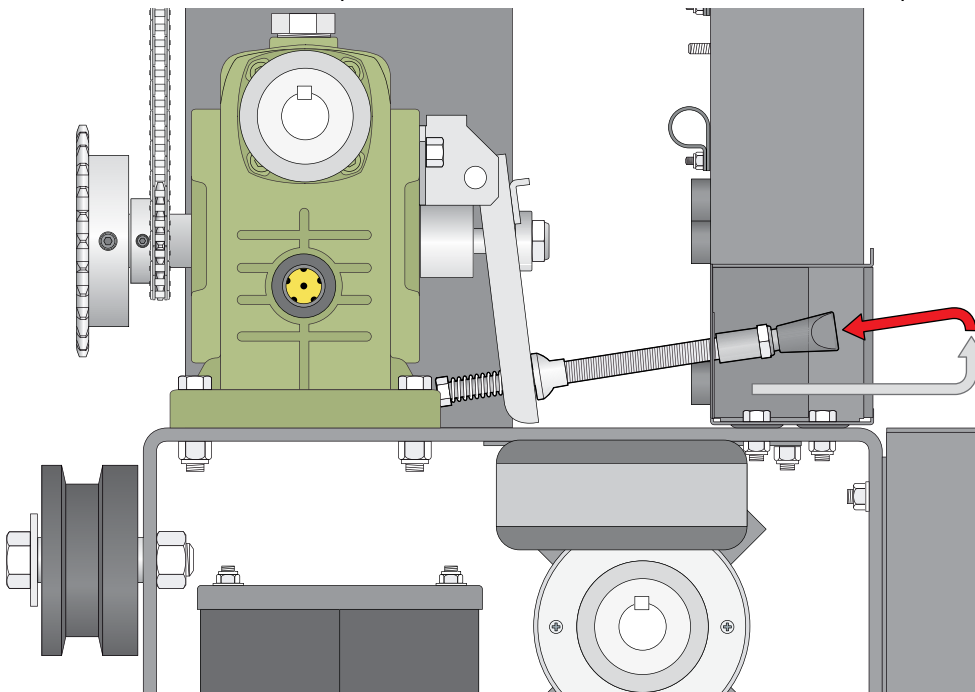

### 3 Manually Push Gate to Desired Position

# SECTION 7 - MAINTENANCE AND TROUBLESHOOTING

Inspection and service of this gate operator by a qualified technician should be performed anytime a malfunction is observed or suspected. High cycle usage may require more frequent service checks.

## 7.1 Maintenance

When servicing the gate operator, always check any secondary (external) reversing devices (loops, photocells, etc.) for proper operation. If external reversing devices cannot be made operable, do not place this operator in service until the malfunction can be identified and corrected. **Always check the inherent reversing system when performing any maintenance. If the inherent reversing system cannot be made operable, remove this operator from service until the cause of the malfunction is identified and corrected. Keeping this operator in service when the inherent reversing system is malfunctioning creates a hazard for persons which can result in serious injury or death should they become entrapped in the gate.**

When servicing this gate operator, always turn power **OFF!!** If gearbox requires oil, use only Mobil SHC-629 Synthetic Gear Oil. Do not completely fill gearbox with oil. Gearbox should be half full only. Do not exceed this level.

Operator Component	Maintenance	Monthly Interval		
		3	6	12
<b>Alarm</b>	Activate the primary (inherent) reverse system by blocking the gate with a solid object. When the gate reverses, block the gate in the opposite direction prior to the limit being reached. The entrapment alarm should activate. Press the reset button to silence the alarm.	✓		
<b>Drive Belt</b>	Check for alignment, tightness and wear.		✓	
<b>Chain</b>	Check for sagging. Tighten if necessary.		✓	
<b>Fire Dept.</b>	Check emergency vehicle access device for proper operation.	✓		
<b>Gate</b>	Inspect for damage. Check gate wheels, rollers and guides for wear and grease if necessary.		✓	
<b>Grease</b>	Wheels, guide rollers and limit nuts if necessary.		✓	
<b>Loop(s)</b>	Check vehicular exit and reverse loops for proper operation.	✓		
<b>Primary Reverse System</b>	Check that the gate reverses on contact with an object in both the opening and closing cycles. Adjust the reversing sensor and/or clutch if necessary.	✓		
<b>Pulleys</b>	Check for alignment. Check setscrews.		✓	
<b>Release</b>	Check manual release for proper operation.	✓		
<b>Secondary Reverse Device</b>	Check secondary (external) reverse device(s) stop or reverse the gate when activated.	✓		
<b>Batteries</b>	Check the batteries for any leakage or loose connections. Batteries should be replaced every two years.	✓		
<b>Complete System</b>	Complete check of gate and gate operating system.			✓

## 7.2 Built-in Diagnostics

This gate operator is designed with built-in diagnostics that will alert you to potential or existing problems that the microprocessor has detected. Specific fault conditions are checked and the operator will signal that a fault exist through the built-in alarm.

**Constant alarm is heard when power is applied:** This indicates that the limit switch wire harness is not connected to the circuit board. In this condition, the operator will not run and the tone will continue until the fault is corrected. Check to be sure that the limit switch plugs are properly inserted into P2 and P8.

**Constant alarm is heard:** This indicates that the operator is in a hard shutdown condition. The alarm will continue to sound for five minutes, and then will “chirp” once every five seconds. The operator-reset button must be pressed or power must be removed and then reapplied to return the operator to normal operation.

**Short “alarm chirp” is heard every five seconds:** This indicates that the operator has been in a hard shutdown condition in excess of five minutes. This will continue until the operator-reset button is pressed or until power is removed from the operator.

**Operator runs for 1 second and stops, two short “alarm chirps” are heard:** This indicates that there may be a fault with the primary current sensor circuit. Check that the black current sensor wire has been passed through the hole in the primary current sensor donut on the circuit board with the correct number of loops (1/2 HP motor - 2 loops, 1 HP motor - 1 loop).

## 7.3 Troubleshooting

Have a good VOM meter with Min/ Max test button to check voltages and continuity. A Meg-Ohm meter capable of checking up to 500 meg-ohms of resistance is necessary to properly check the integrity of the ground loops. When a malfunction occurs, isolate the problem to one of three areas: 1) the operator, 2) the loop system, 3) the keying devices. **Use caution when checking high voltage areas.**

1. Check the input indicator LEDs. They should only come ON when a keying device (card reader, push button, etc.) is activated. If any of the input LEDs are ON continuously, this will cause the gate operator to hold open. Disconnect the keying devices one at a time until the LED goes OFF.
2. Check any external secondary entrapment protection devices. Any short or malfunction in these devices can cause the gate operator to stop or to hold open.
3. A malfunction in a loop or loop detector can cause the gate operator to hold open, or to not detect a vehicle when it is present over the loop. The LEDs next to the loop detector ports on the operator circuit board will light only when the loop has detected an object above it. If the LEDs stays on after the object has gone, then the loop detector has malfunctioned. Pull the loop detector circuit boards from the loop ports on the operator circuit board. If the malfunction persists, the problem is not with the loop system. For more information on trouble shooting loops and loop detectors, refer to your loop detector instruction sheet and to the DoorKing Loop and Loop Detector Information Manual.
4. Check to be sure that there are no shorted or open control wires from the keying devices to the gate operator. If a keying device fails to open the gate, momentarily jumper across terminals 1 and 2 (or 1 and 6) on the gate operator circuit board. If the gate operator starts, this indicates that a problem exist with the keying device and is not with the gate operator.
5. Check the supply voltage line. A voltage drop on the supply line (usually caused by using too small supply voltage wires) will cause the operator to malfunction.

Symptom	Possible Solution(s)
Operator will not run. Power LED is OFF.	<ul style="list-style-type: none"> <li>• Check that power to the operator is turned ON.</li> <li>• Check for AC power (115/230) at the power input terminals. If power is absent, check incoming power to operator.</li> <li>• Be sure AC power switch is ON. Check for 24 VDC at P2, terminals 1 (+) and 2 (-). If no power, faulty bridge rectifier or toroidal transformer. If power is present, possible faulty board.</li> </ul>
Operator will not run. Power LED is ON.	<ul style="list-style-type: none"> <li>• Press “Push to Operate” button or momentarily jumper terminal 1 to terminal 2 (or 1 to 6). If the input LED does not come ON, check the terminal strip or replace the circuit board. If LED does come ON, proceed to next steps.</li> <li>• <b>Check Motor:</b> Gate must be half way open before testing motor.               <ol style="list-style-type: none"> <li>1. <b>Turn AC power OFF</b> and remove plug P2 from circuit board. On the P2 terminal, connect terminal 1 to terminal 5 and terminal 2 to terminal 6. Turn AC power <b>ON – CAUTION – HIGH VOLTAGE</b>. The motor should run, turn power <b>OFF</b>.</li> <li>2. <b>With AC power still OFF</b>. Connect terminal 1 to terminal 6, and terminal 2 to terminal 5. Turn AC power <b>ON – CAUTION – HIGH VOLTAGE</b>. The motor should run in the opposite direction as terminal 1 to terminal 5 and terminal 2 to terminal 6, turn power <b>OFF</b>.</li> <li>3. If the motor does not run, or runs in only one direction, problem can be a bad motor, wire connections from the control board to the motor or a bad control board. If the motor runs in both steps above, continue troubleshooting control board and accessories.</li> </ol> </li> </ul>

Symptom	Possible Solution(s)
Secondary operator motor will not run.	<ul style="list-style-type: none"> <li>• Check that SW-2, switch 3 is ON.</li> <li>• <b>Check Motor:</b> Gate must be half way open before testing motor. <ol style="list-style-type: none"> <li>1. <b>Turn AC power OFF</b> and remove plug P2 from circuit board. On the P2 terminal, connect terminal 1 to terminal 5 and terminal 2 to terminal 6. Turn AC power <b>ON – CAUTION – HIGH VOLTAGE</b>. The motor should run, turn power <b>OFF</b>.</li> <li>2. <b>With AC power still OFF</b>. Connect terminal 1 to terminal 6, and terminal 2 to terminal 5. Turn AC power <b>ON – CAUTION – HIGH VOLTAGE</b>. The motor should run in the opposite direction as terminal 1 to terminal 5 and terminal 2 to terminal 6, turn power <b>OFF</b>.</li> <li>3. If secondary motor does not run, or runs in only one direction, problem can be in the wiring from the primary to secondary operator, bad secondary motor</li> </ol> </li> </ul>
Gate will not reverse when an obstruction is encountered.	<ul style="list-style-type: none"> <li>• Check ERD (Reverse Sensor) setting.</li> </ul>
Gate opens a short distance, then stops and reverses.	<ul style="list-style-type: none"> <li>• Check the reversing sensitivity.</li> <li>• Disconnect the gate from the gate operator and check that the gate slides freely without binding.</li> <li>• Gate might be too heavy.</li> <li>• Continue troubleshooting.</li> </ul>
Gate opens but will not close.	<ul style="list-style-type: none"> <li>• Check the input LEDs. Any ON will hold the gate open and indicates a problem with a keying device.</li> <li>• Check the secondary safety devices. Any activated will hold the gate open and indicates a problem with the safety device.</li> <li>• Check the loop detectors. Any activated can hold the gate open and indicates a problem with the loop detector or ground loop.</li> <li>• Operator may be in a “soft shutdown.” Activate any keying device to determine if operator returns to normal operation.</li> <li>• If automatic close is desired, be sure SW-1, switch 2 is ON.</li> <li>• Check motor as described above.</li> </ul>
Gate closes but will not open.	<ul style="list-style-type: none"> <li>• Operator may be in a “soft shutdown.” Check input LEDs. If any are ON, momentarily disconnect, then re-connect the wire going to the respective terminal. Operator should open.</li> <li>• Check to be sure that the operator is running in the proper direction. Turn power OFF, and then back ON. Activate a keying device. Operator should run in the open direction. If operator runs in the close direction, turn power OFF and change direction switch SW-1, switch 1. Go to above section if operator now opens but will not close.</li> <li>• Be sure that the respective LED on the control board lights when the keying device connected to the respective terminal is activated. If LED does not light, momentarily place a jumper wire from terminal 1 to the input terminal being checked. If LED lights and gate opens, problem is with the keying device. If LED does not light, replace control board.</li> <li>• Check motor as described above.</li> </ul>
Gate starts to close, then reverses to open.	<ul style="list-style-type: none"> <li>• Check that the reverse sensitivity is properly adjusted.</li> <li>• Disconnect the gate from the operator and check that the gate operates freely without any binding.</li> <li>• Check the loop detector LEDs and input LEDs. Any that flash ON will cause the gate to reverse.</li> <li>• Check for proper loop wiring. A mis-wired loop detector will cause the gate to reverse.</li> <li>• Continue troubleshooting.</li> </ul>
Gate closes and then re-opens.	<ul style="list-style-type: none"> <li>• Check for any input or loop detector LEDs that are ON.</li> <li>• Check that the operator is running in the proper direction (see “gate closes but will not open” above).</li> </ul>
Alarm sounds for 5 minutes and then chirps once every 5 seconds. Operator will not run.	<ul style="list-style-type: none"> <li>• Operator is in a “hard shutdown” condition. Reset button must be pressed to return operator to normal operation.</li> </ul>

## 7.4 Accessory Items

The following accessory items are available for the model 9024 slide gate operator.

**Contact Sensors** - For use as a secondary entrapment protection device. Miller Edge, Inc., MGO20, MGR20, MGS20

**Photo Cell** - Non-contact (photocell) sensors for use as a secondary entrapment protection device.

MMTC, Inc. Model IR55 - P/N 8080-010      MMTC, Inc. Model 60-278 - P/N 8080-011

Carlo Gavazzi Type PMP12 - P/N 8080-030      Carlo Gavazzi Type PMT - P/N 8080-031

**Plug-In Low Current Draw Loop Detector** - Detectors plug directly into ports on circuit board simplifying wiring. Can be used with solar powered operators.

Single channel detector - P/N 94??-010      Dual channel detector - P/N 94??-010

**Loop Wire** - 18 AWG loop wire with XLPE insulation is ideal for ground loops. Available in 500 and 1000 foot rolls. Red, blue or black insulation.

**Pre-Fab Loops** - Prefabricated ground loops. 24-foot circumference with 50-foot lead-in. Available in yellow, red or blue jackets. Not for use in asphalt roadways.

**Loop Test Meter** - Meg-ohm meter checks the integrity of ground loops. P/N 9401-045

**Time Clock** - 7 day and 365 day time clocks can be used to automatically open gate at pre-set time and days. Compact clock fits inside the operator. 7 day clock - P/N 2600-791      365 day clock - P/N 2600-795

**208/230 VAC Heater with Fan Assembly Kit** - Thermostatically controlled heater and fan for cold and hot environments. For 208/230 VAC input power ONLY. P/N 1601-197

**V-Wheels** - 4 inch and 6 inch. UHMW or Steel. Roller bearings or sleeve bearings. Single or tandem wheel configurations.

**Endless Idler Assembly with Protective Cover** - Use when gate operator chain needs 180° return. P/N 2600-818

**Guide Rollers with Protective Covers** - A variety of sizes to support slide gates.

**Gate End Retainer** - Fits on top of end post and helps stabilize the end of the gate in the open or closed position (End post NOT provided). P/N 1204-004

**Post Mount Kit** - Required for post mount installation. P/N 9000-015.

**Chain Tray Kit** - 10 Ft. section. Sections connect together to fit any length gate. P/N 2601-270

**Additional #40 Chain** - 20 ft. per box. P/N 2600-442

**Surge Devices** - High and low voltage surge suppressors help prevent circuit board failure caused by lightning strikes and power surges. High Voltage - P/N 1876-010      Low Voltage - P/N 1878-010

**Speed Bumps** - Prefabricated six-foot speed bump reduces traffic speed through gate system. P/N 1610-150

**12 Volt 18 Amp/Hr Extended Battery** - P/N 1801-004. Two (2) required.

**24 VDC Solar Power Kit** - P/N XXXX-XXX.



# Model 9024-081 Solar Input Power ONLY

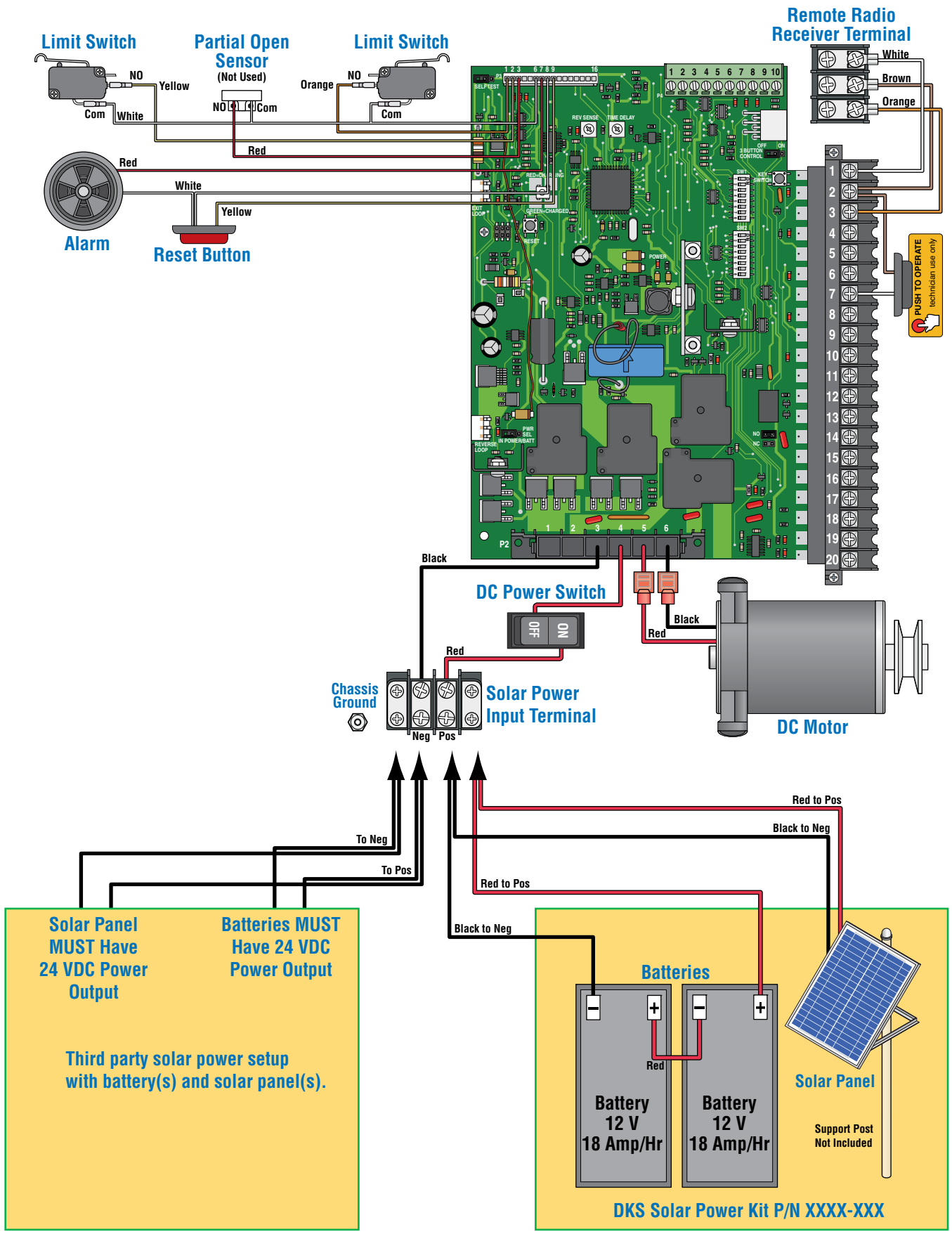

**Solar Panel MUST Have 24 VDC Power Output**

**Batteries MUST Have 24 VDC Power Output**

Third party solar power setup with battery(s) and solar panel(s).

**Batteries**

Battery 12 V 18 Amp/Hr

Battery 12 V 18 Amp/Hr

**Solar Panel**

Support Post Not Included

**DKS Solar Power Kit P/N XXXX-XXX**



[www.doorking.com](http://www.doorking.com)

DoorKing, Inc.  
120 S. Glasgow Avenue  
Inglewood, California 90301  
U.S.A.

Phone: 310-645-0023  
Fax: 310-641-1586