



TRAFFIC CONTROL

TRAFFIC SPIKES ABOVE & IN-GROUND

TRAFFIC CONTROL SPIKE SYSTEMS

Surface Mount

- Modular System can accommodate any traffic lane width
- Spikes are ganged 3 and 4 Spikes together
- Lock Down allows for temporary two-way traffic
- Spikes are available in 3 ft sections

Flush Mount

- Spring-loaded or counterweight (non-spring) models available
- Each Spike is independently spring-loaded or weighted
- Available in 6 ft sections
- Lock Down option available

Speed Bump

- Solid composite material provides a long service life
- Warning Sign MUST be used with installation of all Traffic Spikes

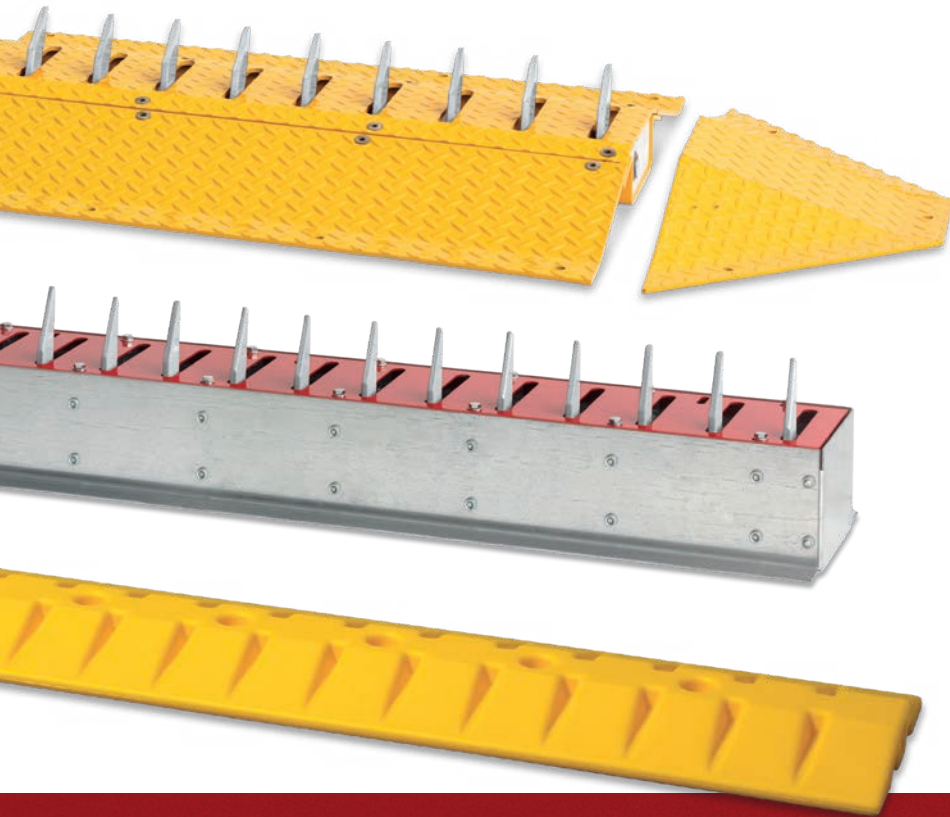

PARKING • MIXED USE • COMMERCIAL/INDUSTRIAL •
SELF STORAGE • MAXIMUM SECURITY



Surface Mount
install easily without trenching



Flush Mount
available with weighted or
spring loaded spikes



Lock Down
flush mount version available

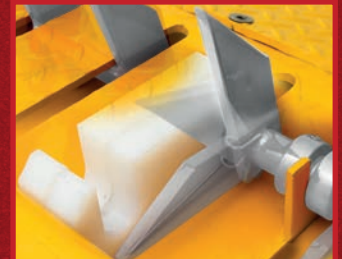

Spring Loaded
surface mount available in 3 ft sections

ACCESS CONTROL SOLUTIONS



1610 TRAFFIC CONTROL

TRAFFIC SPIKES ABOVE & IN-GROUND

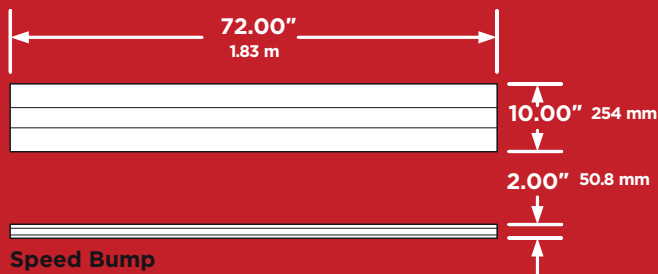
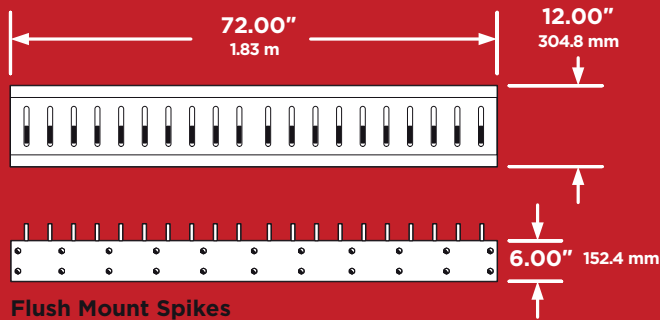
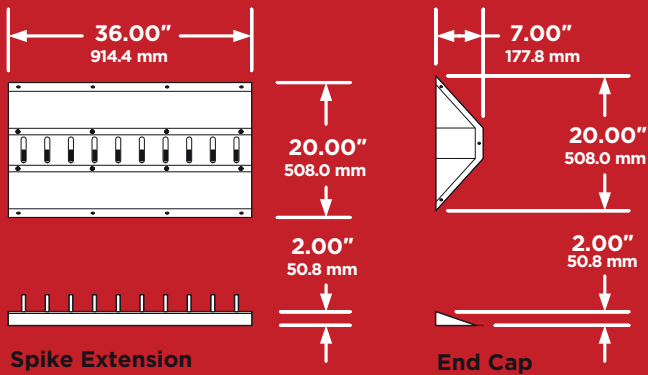
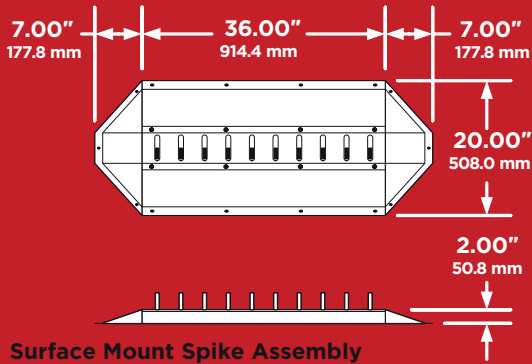

TECHNICAL FEATURES

SURFACE MOUNT SPIKES

Mounting

Anchored to concrete surfaces only

Spike operation

Spring-loaded

Spikes are ganged 3 and 4 together and use a torsion spring for operation

End Cap

Provides a smooth end to the Spike section

Housing

1/4-inch diamond plate painted safety yellow

2-inch rise provides a built-in speed bump

Lock Down

Feature allows Spikes to be locked in the "down" position allowing the traffic lane to be temporarily used for two-way traffic

Weight Limit

8,000 Lb. per axle

FLUSH MOUNT SPIKES

Mounting

Flush, in-ground unit anchored in concrete

Spike operation

Spring-loaded - each Spike has an independent stainless steel spring

Weighted - each Spike is independently counter weighted

Housing

Galvanized Steel to inhibit rusting. Top plate is painted bright red for easy visibility

Lock Down Option

Optional feature allows Spikes to be locked in the "down" position allowing the traffic lane to be temporarily used for two-way traffic

Weight Limit

8,000 Lb. per axle. Heavy-duty flush units available with 20,000 weight limit per axle.

SPEED BUMP

Mounting

Surface mount, anchored to concrete surfaces only

Solid composite material painted safety yellow

Installation and use of spike components in areas that are subject to freezing weather with potential for snow and ice accumulation is not recommended.

Illuminated LED Warning Sign (1610-080) MUST be used with the installation of spike systems.

DoorKing® Inc.

Access Control Solutions since 1948



120 S. Glasgow Avenue,
Inglewood, California 90301 U.S.A.
Tel: 310-645-0023 FAX: 310-641-1586
www.doorking.com

© 2021 All Rights Reserved.
Product specifications may
change without notice. Rev. 5/21



MEMBER:



DISTRIBUTED BY:

