

QUICKSTART "BASIC" GUIDELINES FOR MODEL 6004 - FOR GATES UP TO 8 FEET, 300LBS AND "OPENING TO THE INSIDE"

UL 325 August 2018 Standard



120 S. Glasgow Avenue
Inglewood, California 90301
U.S.A.

"Open to the Inside" Installation

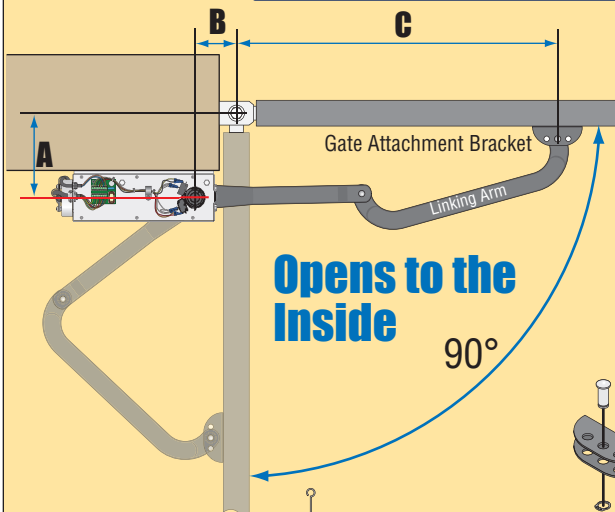

Note: Refer to 6004 manual for "Open to the Outside" installation.

Position of Operator and Arms

"A" inches	"B" inches	C max. inches
2.50 - 4.25	4.25 - 5.00	28.75
4.25 - 6.25	4.25 - 5.00	28.25
6.25 - 8.25	4.25 - 5.00	28.00
8.25 - 10.25	4.25 - 5.00	27.25
10.25 - 12.25	4.25 - 5.00	27.00
12.25 - 14.00	4.25 - 5.00	26.25

Note: Linking arm must be in the center hole of the gate attachment bracket.

THIS PRODUCT IS TO BE INSTALLED AND SERVICED BY A TRAINED GATE SYSTEMS TECHNICIAN ONLY. Visit www.dkslocator.com to find a professional installing and servicing dealer in your area.

The 6004 is intended for installation only on swing gates used for vehicles. Pedestrians must be supplied with a separate access opening. For safety and installation instructions, please refer to 6004 Actuator Arm and Control Box Mounting manual, 115 VAC or Solar Control Box Wiring/Owner's manuals.

Opening Direction DIP-Switch 1 (SW 1)

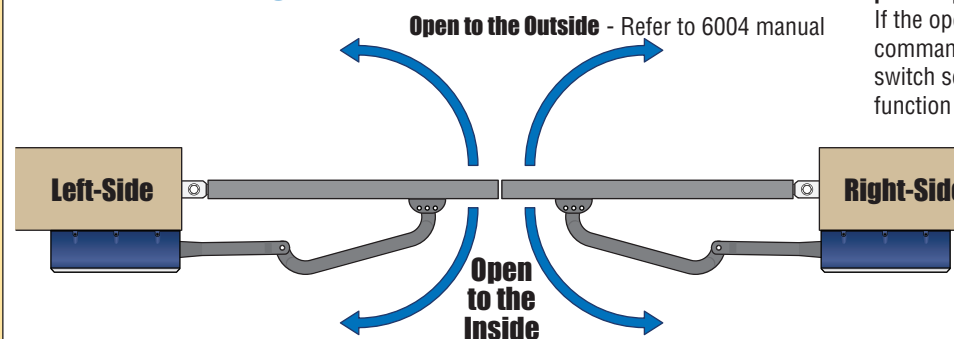

The operator MUST OPEN GATE upon initial power up and OPEN command. If the operator closes gate after giving open command, shut off power and reverse this switch setting otherwise operator will NOT function correctly.

Refer to YOUR chosen 115 VAC OR Solar powered control box manuals for complete DIP-switch settings.

Wiring to Circuit Board

Factory wired jumpers MUST be removed.

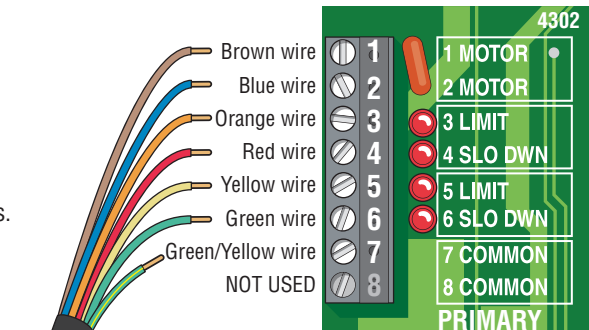

Single operator connects to PRIMARY connection ONLY on the 115 VAC OR Solar control box circuit board.

Control Box

Securely mount a control box near the actuator arm with appropriate hardware (not supplied).

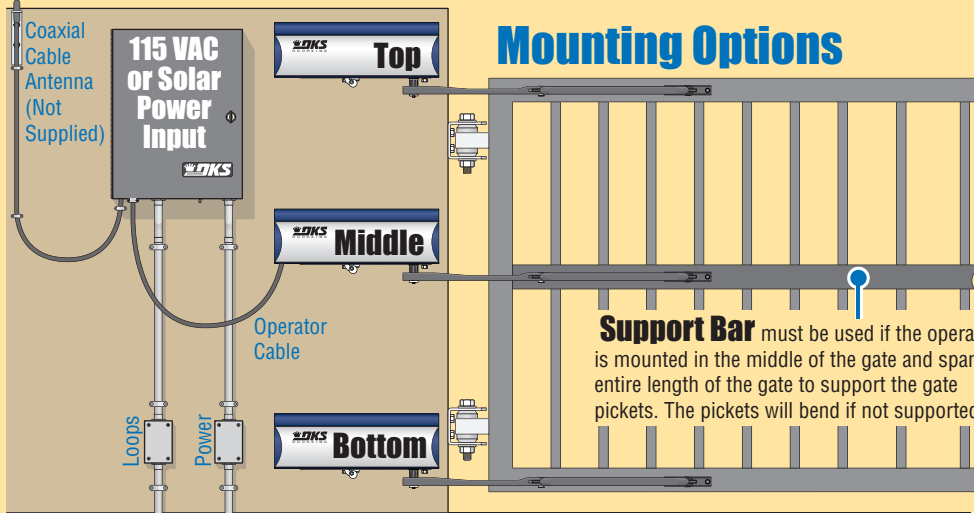

Mounting Options

Support Bar must be used if the operator is mounted in the middle of the gate and span the entire length of the gate to support the gate pickets. The pickets will bend if not supported.

Installing Mounting Bracket and Gate Attachment Bracket

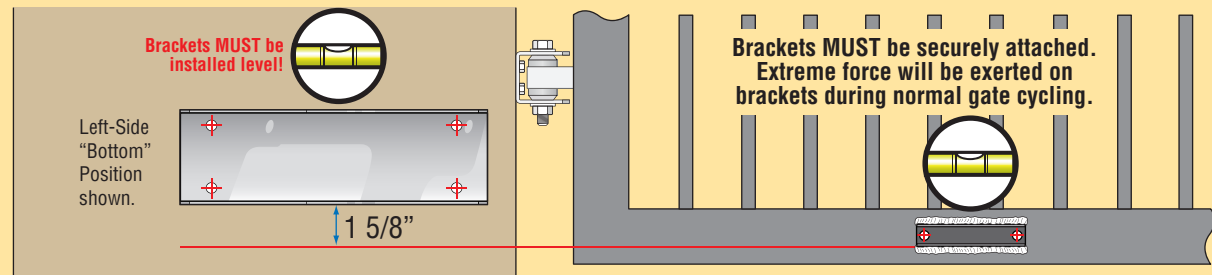

Attach mounting bracket to pilaster or wall with four (4) #10 screws and suitable expansion hardware (Not supplied).

Weld gate attachment bracket to gate or use two (2) suitable screws (Not supplied).

Operator Disassembly

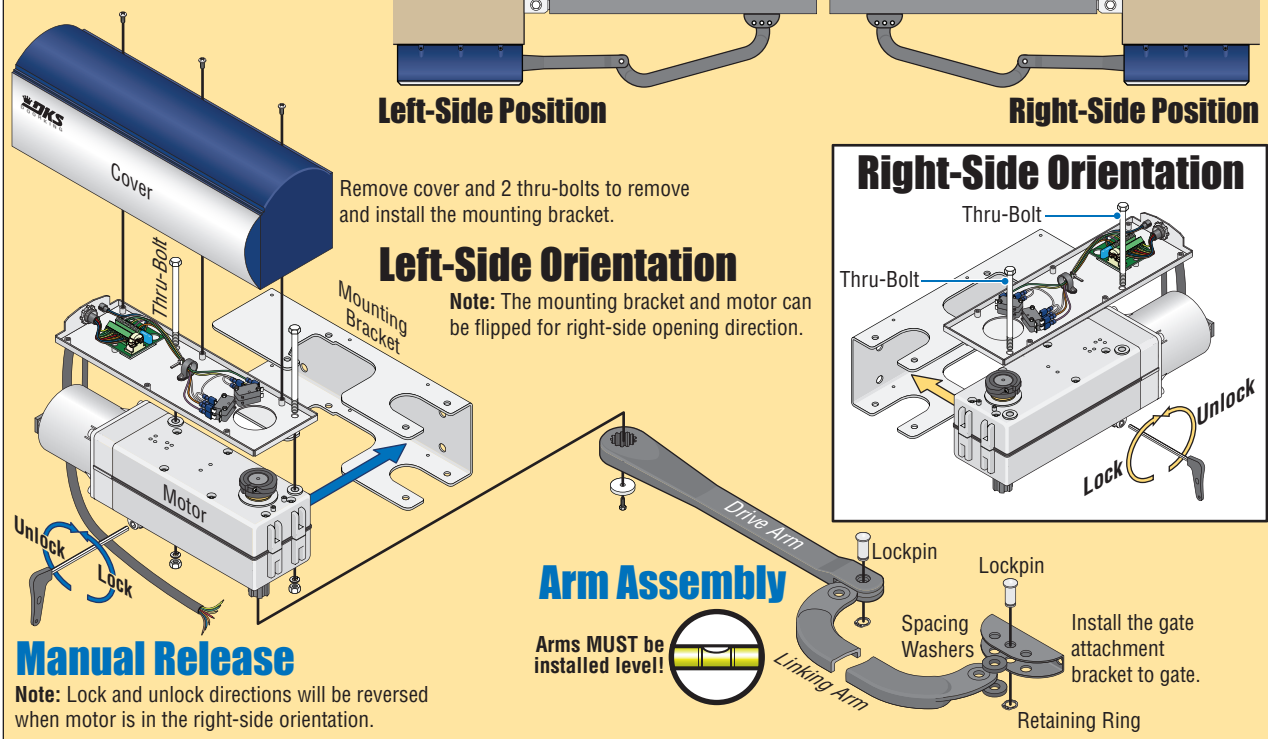

Manual Release

Note: Lock and unlock directions will be reversed when motor is in the right-side orientation.

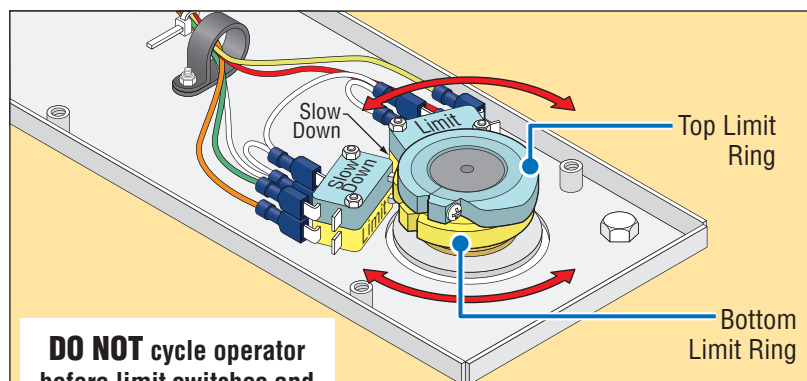

DO NOT cycle operator before limit switches and DIP-switches have been adjusted, damage could occur to gate and operator.

Manually move the gate to the desired open or closed position. Loosen the limit screws and slowly rotate the limit rings until the LIMIT LEDs on the circuit board light up.

Limit Switch Adjustment

Circuit board power must be ON when adjusting the limit rings, LEDs will light while turning the limit rings.

Note: Only 1 monitored Device can be connected for each cycling direction. An OPTIONAL Expansion Kit (sold separately) will allow connection for additional devices. Refer to YOUR chosen 115 VAC OR Solar powered control box manuals to wire entrapment protection devices.

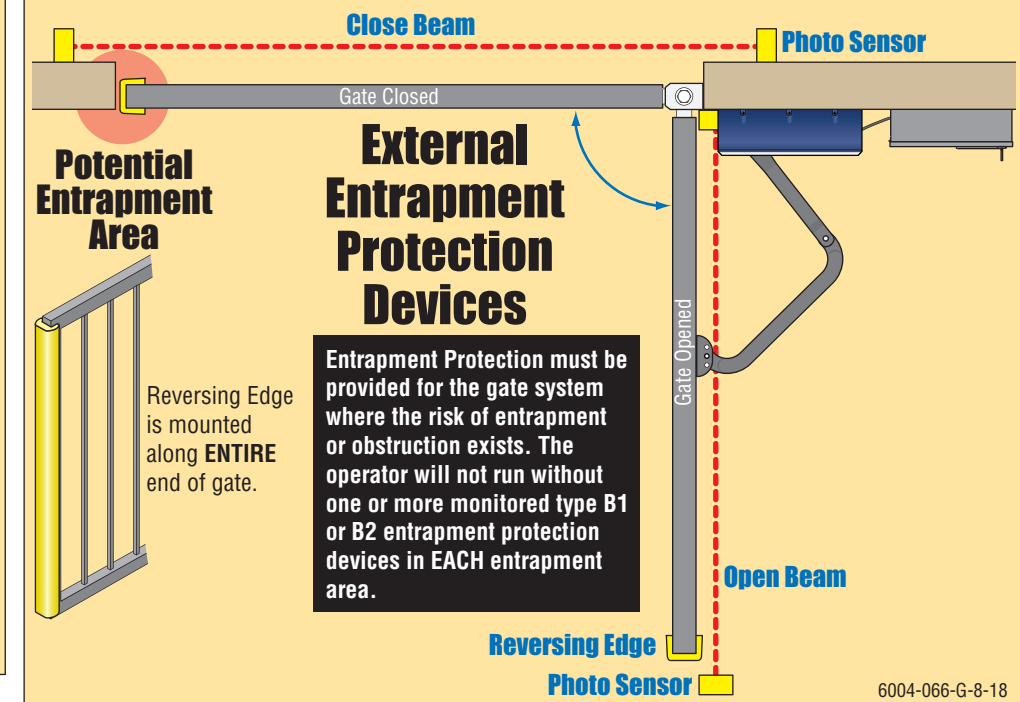

External Entrapment Protection Devices

Entrapment Protection must be provided for the gate system where the risk of entrapment or obstruction exists. The operator will not run without one or more monitored type B1 or B2 entrapment protection devices in EACH entrapment area.